

Exploring Coffee Secrets



H2

Fully automatic coffee machine user manual

Contents

1	Introductions	4
1.1	Greetings	4
1.2	About the manual	4
1.3	Machine description	4
2	Machine description	5
2.1	Machine introductions	5
2.2	Functional description	6
2.3	Technical parameters	7
2.3.1	Output capacity	7
2.3.2	Specification parameters	7
2.3.3	Grinding index description	8
2.3.4	ECO mode description	8
2.3.5	Description of beverage parameters	8
2.4	Accessories	9
2.4.1	Accessories supplied	9
2.4.2	Accessories and device options	9
3	Electrical schematic	10
4	Security matters	11
4.1	Application	11
4.2	Safety warning	11
4.2.1	User risks	11
4.2.2	Hazards to Machine	13
4.2.3	Dangers of cleaning agents	14
4.2.4	Health rules	15

There is difference between picture and products, because of the upgrading of products. Please refer to the actual products.

5	Installation and testing	17	9	Trouble shooting and Handling	37
5.1	Placement Requirements	17	10	Liability and Warranty	39
5.1.1	Location	17	10.1	User responsibility	39
5.1.2	Climate conditions	17	10.2	Warranty and Liability	39
5.1.3	Power conditions	18			
5.1.4	Water conditions	18			
5.2	First run	19			
5.3	Machine On/Off	20			
5.4	Remove and install bean box	21			
6	Beverage making	21			
6.1	Coffee	21			
6.2	Milk Beverage	23			
6.3	Hot water	24			
7	Cleaning and maintenance	26			
7.1	Daily cleaning	26			
7.1.1	Brewer rinse	26			
7.1.2	Milk rinse	27			
7.1.3	Milk frother disassembly and cleaning	28			
7.2	Regular maintenance	30			
7.2.1	Brewer deep clean	30			
7.2.2	Milk deep clean	32			
7.2.3	Descaling	34			
7.2.4	Grinding adjustment	35			
8	Precautions for daily use and maintenance	36			

1 Introductions

1.1 Greetings

- This coffee machine is the latest generation of fully automatic coffee machines we have developed. Its design fully reflects our core technology.
- The manual introduces the coffee machine and use rules. Be sure to follow our Terms of Use and Precautions. For more information, please contact our customer service.
- The performance of coffee machine depends on proper maintenance and use. Please read the instruction manual carefully before using the coffee machine for the first time. Happy using!

1.2 About manual

- This manual is default part, please always keep it in the place where the product is used and keep it clearly readable.
- Due to the further development of technology, we reserve the right to revise this manual, and unauthorized photocopying and modification are prohibited.
- This manual applies to the model: H2

1.3 Machine description

- For use only to make coffee, hot water and milk, do not use for other purposes.
- The housing is made of high-grade plastic. This machine and all auxiliary equipment are designed to comply with the following operator obligations:
 - HACCP Sanitation Guidelines;

- Accident prevention regulations for electrical safety in the commercial sector;
- The operation of this machine is performed via a touch-sensitive screen (touch screen).

2 Machine description

2.1 Machine introductions

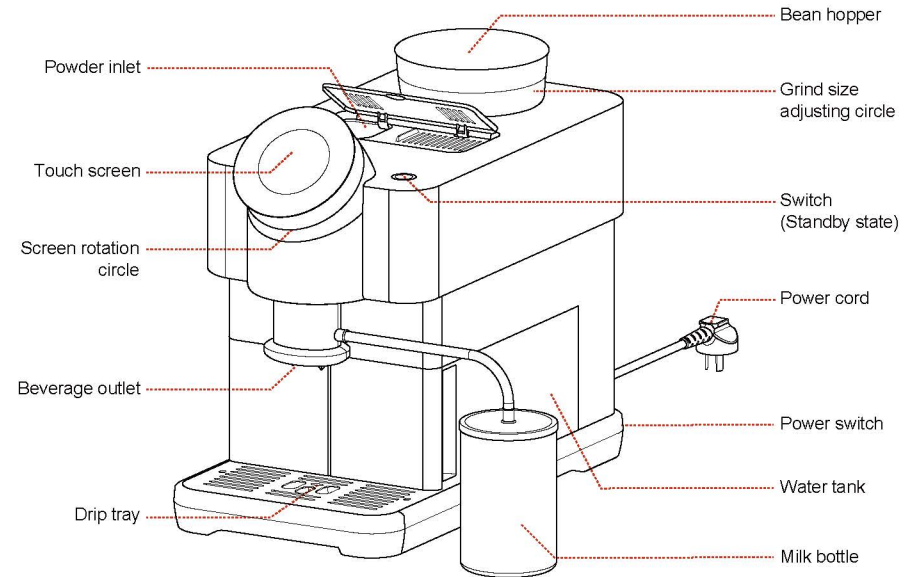

2.2 Functional description

- Coffee Powder Inlet/tablet inlet: only for delivery of coffee powder and cleaning tablets;
- Touch Screen: 4-inch touch screen;
- Screen Swivel: swivel to select drinks;
- Beverage outlet: adjustable height 90-140mm;
- Drip tray: undertake waste water and coffee grounds, coffee exports to the top can be pulled out of the drip tray to dump waste water and coffee grounds;
- Bean hopper: only put in coffee beans, not other bean products;
- Grinding adjustment ring: rotating grinding bean adjustment ring can adjust grinding bean shift, the larger the scale of the numerical marks the thicker, the smaller the finer;
- Switch: Turn Machine on and off (standby);
- Power cord: length 1 meter;
- Power Switch: the power switch for the coffee machine, located behind the machine;
- Water tank: only for pure water or tap water;
- Milk jug: Only for Milk or frsh milk.

2.3 Technical Parameters

2.3.1 Output capacity

Cups per hour based on DIN18873-2:

Daily output	20 Cups
Cups per hour	
Espresso (Volume30ml)	50 Cups
Americano (Volume160ml)	35 Cups
Cappuccino (Volume200ml)	30 Cups
Hot water output per hour	8L
Water tank capacity	1.5L
Coffee bean hopper capacity	Around 200g
Grounds container capacity	About 10 pcs (10g/piece)

2.3.2 Specification parameters

Rated voltage	220V
Rated Frequency	50Hz
Rated power	1350W
Machine W*D*H	24*46*40cm
Net weight	11kg
Gross weight	13.5kg

2.3.3 Grinding index description

Grinding index description 0.7-1.3(default 1.0) means $(0.7-1.3) \times$ current grinding amount

For example:

Grinding index set to 0.7 means the brewing powder quantity is 0.7 times the default powder quantity.

Grinding index set to 1.3 means the brewing powder quantity is 1.3 times the default powder quantity.

2.3.4 ECO mode description

ECO mode 1: One hour of unmanned operation of the machine, the screen dims 50% , the interface appears ECO screensaver; click the screen to enter the main interface, you can make drinks.

ECO mode 2: half an hour unattended operation of the machine, screen black, enter soft shutdown mode; press the right top switch of the machine to enter the main interface, you can make drinks.

2.3.5 Description of beverage parameters

Default beverage parameters							
Drinks	Grounds	Pre-Brewing(s)	Coffee(ml)	Hot Water(ml)	Milk Foam(s)	Extraction Control	Temp Level
Parameter adjustment range	1-5 (The higher the number, the more ground coffee there is)	0-5 (Pre-brewing time)	10-240	0-300	1-90	Standard Strong Extra-Strong	Low Temp Mid Temp High Temp
Espresso	3	1	30	\	\	Standard	High Temp
Cappuccino	3	0	25	\	35	Standard	High Temp
Caffe Latte	3	2	30	\	60	Standard	High Temp
Americano	3	0	40	120	\	Standard	High Temp
Milk Foam	\	\	\	\	30	\	\
Hot Water	\	\	\	150	\	\	\

PS: Strong:The extraction time around 50's; Extra-Strong:The extraction time around 60's.





2.4 Accessories

2.4.1 Accessories supplied

This model supply the spare parts as follows:

Name	Picture	Qty
Machine		x1
User Quick Guide		x1
Milk bottle		x1

2.4.2 Accessories and device options

Name	Picture	Description
Espresso machine cleaner		For coffee machine brewing system deep clean, eliminate the coffee grease inside the brewer, non-toxic and tasteless.
Milk system coffee machine cleaner		For deep cleaning of milk bottle and milk system,eliminate the residue of milk scale inside the milk froth, non-toxic and tasteless.
Filtel		It can effectively filter impurities in water, reduce heavy metals, soften water quality, reduce scale formation, protect waterway and heating system of coffee machine.
Descaling powder		For descaling,remove limescale from the coffee machine container to ensure the pure taste of coffee.

3 Electrical schematic

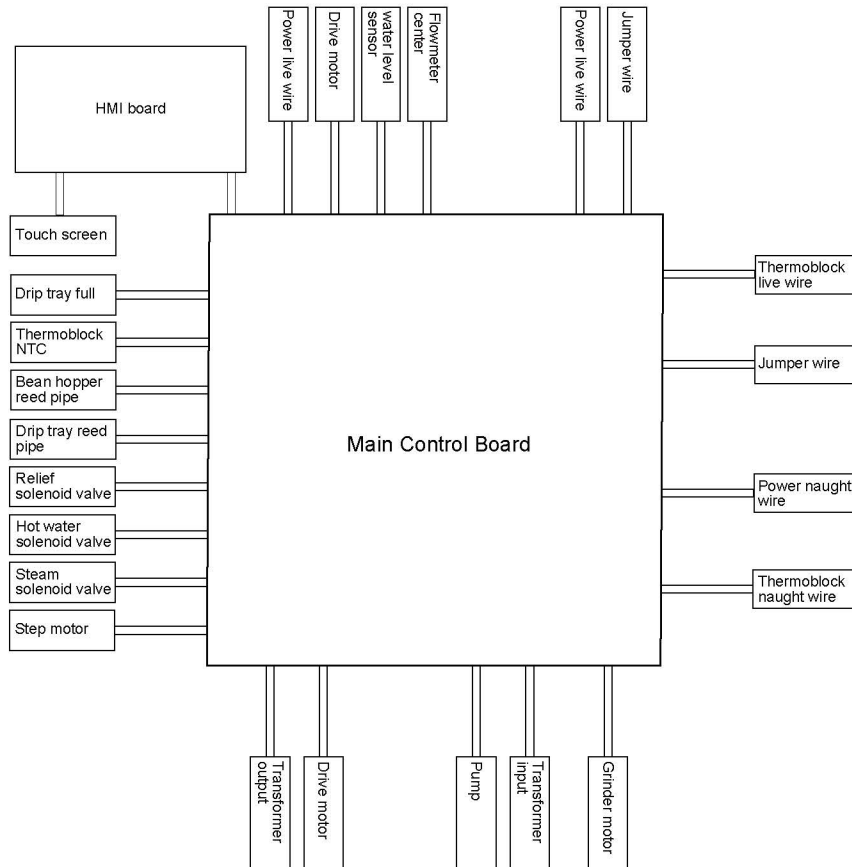

4 Security matters

Optimum Safety One of Dr. Coffee's most important product features. The effectiveness of the safety device can only be guaranteed if the instructions for use in the following chapters are followed.

4.1 Application

This machine and all auxiliary equipment are suitable for use in the following working states:

- Under supervision, self-service operation runs (standby mode);
- Use a solid water connection;
- Filtered municipal water;
- Fixed location in a dry, closed room.

This machine and all auxiliary equipment must not be used in the following ways:

- In areas with high air humidity (e.g. cloud steaming areas) or outdoor areas;
- On transport or in movable space (consult manufacturer).

4.2 Safety warning

4.2.1 User risks



Attention: Incorrect use of the coffee machine can cause minor injury. Be sure to observe the following points:

- Please read the instructions carefully before use;
- Do not use if coffee machine is not functioning properly or is damaged;
- It is strictly forbidden to modify the built-in safety device;
- Do not touch high temperature machine parts;
- Children over 8 years of age and persons with physical, sensory or intellectual impairments or lack of experience and cognition must learn how to operate the machine safely and understand the dangers that result before using the machine under continuous supervision;

- Please supervise children, avoid children playing with the machine, cleaning and user maintenance should not be carried out by children;
- Install the coffee machine in a place where it can be looked after and maintained at any time;



Warning electric shock: Improper use of electrical equipment can result in electric shock. Please observe the following points:

- Work on electrical equipment may only be carried out by electrical professionals;
- The machine must be connected to a circuit protected by fuses (we recommend laying the wiring through a leakage protector);
- Please abide by the relevant low voltage directives and national or local safety regulations;
- When connecting, it must be grounded in strict accordance with regulations and prevent electric shock;
- The voltage must be consistent with the description on the equipment nameplate;
- Do not touch live parts;
- Always switch off the main switch and disconnect the device from the mains before carrying out maintenance work;
- The power cord should only be replaced by a professional service technician.



Scalding Hazard: Risk of scalding in areas where beverages, hot water and steam are made. Do not put your hands under the spout during preparation or cleaning.



Scalding Hazard: High temperature may be present at the spout and the brewing unit. Only allow access to handles pre-designed for production. Clean the brewing unit only after the machine has cooled down.



Crush Caution: There is a risk of crushing by touching any moving parts. Do not reach into the coffee bean hopper or opening of the brewing unit when the machine is switched on.

4. 2. 2 Hazards to Machines



WARNING: Incorrect use of the coffee machine may result in damage or contamination of the machine.

Please observe the following points:

- Damage to the coffee machine due to calcification if the carbonate hardness in the water exceeds 5°dKH;
- Please abide by the relevant low voltage directives and/or national and local safety rules and regulations; do not turn on the machine if water cannot be filled. Otherwise the boiler will not be refilled and the pump will run "dry";
- The coffee machine must be cleaned and then restarted after a prolonged shutdown;
- Protect the coffee machine from weather (frost, humidity, etc.);
- Troubleshooting can only be done by professional technicians;
- Please use original accessories from Dr. Ka company;
- For external visible damage or leakage, please contact customer service immediately for replacement or repair;
- Do not rinse the machine with water or use steam cleaners;
- Do not place the machine on surfaces that may be sprayed with water;
- Coffee beans can only be installed in the hopper, and only coffee powder can be added at the manual entrance or a cleaning pill is added when cleaning;
- Freeze-dried coffee must not be used, as this will cause the brewing unit to stick;
- If the coffee machine and its accessories are transported at a temperature below 10°C, the coffee machine and its accessories must be left at room temperature (temperature is higher than 10 °C) for three hours after transport before they are plugged in and turned on. Failure to observe this may result in a risk of short circuits due to condensation or damage to electrical components;
- This product cannot be immersed in water for cleaning.

4. 2. 3 Dangers of cleaning agents



Use: Danger of poisoning by ingesting cleaning agents!
Please observe the following points:

- Cleaner storage should be kept away from children .
- Cleaning agents should not be ingested.
- Do not mix cleaners with other chemicals or acids.
- Never add cleaning agents to the drinking water tank.
- Cleaners and decalcifiers should only be used for their intended purpose (see label).
- Do not eat or drink while using the cleaner.
- Good ventilation and exhaust must be ensured when using cleaning agents.
- Wear protective gloves when working with cleaning agents.
- Wash hands thoroughly and immediately after using cleanser.



Storage: Be sure to observe the following points:

- Store out of the reach of children.
- When storing, pay attention to heat, light and moisture.
- Separated from acidic substances.
- Store only in original packaging.
- Keep cleaning agents separate.
- Do not store with food or drink.
- Applicable local laws and regulations on the storage of chemicals (cleaners).



Exhaust Disposal: If the product is not available, the cleaning agent and its receptacle must be disposed of in accordance with local laws.



Emergency Advice: Ask the cleaning agent manufacturer (see detergent label) for the telephone number of the Emergency Advice (Toxicology Advice Center).

4. 2. 4 Health rules



Water: Improper use of water can be a health hazard!
Please observe the following points:

- The water must be clean and free from contamination.
- Do not add corrosive water to the coffee machine.
- The carbonate hardness must not exceed 5~6 °dKH (German carbonate hardness) or 8.9~10.7 °fKH (French carbonate hardness).
- The total hardness value must always be higher than the carbonate hardness.
- The minimum carbonate hardness is 5 °dKH or 8.9 °fKH.
- The maximum chlorine content is 100 mg per liter.
- Ph value 6.5~7 (pH neutral).
- Machines with drinking water tanks (internal & external):
 - Fill the drinking water tank with clean water every day;
 - The drinking water tank must be thoroughly cleaned before adding water.



Coffee: Incorrect use of coffee can be detrimental to your health!
Be sure to observe the following points:

- Check for damage before unpacking.
- Do not add more than one day's worth of coffee beans.
- Close the coffee bean compartment cover immediately after adding coffee beans.
- Coffee should be stored in a dry, cool and dark place.
- Coffee should be stored separately from detergents.
- The oldest product purchased should be used first ("early in, early out" principle).
- Please use it up within the warranty period.
- The package should be well sealed after opening to keep the product in the package fresh and prevent it from contamination.



**Milk: It will harmful for the healthy with incorrect operation of milk!
Please must observe the following points:**

- Don't use raw milk.
- Only pasteurized and heat treated milk.
- Only homogenize milk.
- Only 3-5 °C cold milk.
- Wear gloves during milk treatment.
- Only milk from original package.
- Filling milk into original package is not permitted.
- Thoroughly clean the milk bottle before filling.
- Check the package.
- The filling capacity of milk is no more than the daily usage.
- Close the cover of milk container and cooler after filling (Inside / Outside) .
- Unused milk must not be poured into the original packaging to store.
- Keep the milk in dry, cold and enclosed room.(Highest temperature 7 °C)
- Keep milk separate away from cleaners.
- The oldest purchased product should be used first ("early in, early out" principle).
- Please use it up within the warranty period.
- Seal package after opening it, to prevent it from pollution.

5 Installation and testing

5.1 Placement requirements

5.1.1 location



The following conditions are suitable for placing the coffee machine. Failure to guarantee these conditions could damage the machine. Be sure to abide by the following conditions:

- The installation surface must be stable and flat, and will not deform under the condition of bearing the weight of the coffee machine;
- Do not place near hot surfaces or heat sources and avoid direct sunlight;
- The coffee machine is located so that trained personnel can look after it at all times;
- The distance between the energy interface specified on the site installation drawing and the machine location shall not exceed 1m.
- Reserve some space for maintenance work and operation:
 - Leave enough space above to fill the coffee beans;
 - Keep a minimum distance of 5cm between the back of the device and the wall (air circulation);
 - Observe valid regulations on local cooking techniques.

5.1.2 Climate conditions



The following climatic conditions are suitable for placing the coffee machine. Failure to guarantee these conditions may damage the machine. Be sure to abide by the following conditions:

- Ambient temperature maintained at +10°C to +40°C (50°F to 104°F)
- Relative air humidity up to 80 % rF;
- The coffee machine is designed for indoor use only. Do not use outdoors, protected from weather (rain, snow, frost)!
- If the ambient temperature of the coffee machine is below 0°C, the machine will not start.

5. 1. 3 Power conditions

- The electrical connection must be made in accordance with the relevant regulations of the country in which it is used. The voltage at the installation site must match the voltage given on the nameplate.

Warning electric shock: Danger of electric shock! Be sure to observe the following points:

- It must be protected by a fuse with the amperage value stated on the nameplate!
- All phases of the equipment must be able to be disconnected from the power grid, and the lines connected to the power line must be reliably grounded;
- The electrical equipment on site must be connected according to IEC 364 (DIN VDE 0100).
- Do not operate the machine with a damaged power cord;
- Dr. Coffee recommends that you do not use extension cables! If an extension cable must be used (minimum cross-section: 1.5 mm²), please observe the manufacturer's data (instruction manual) for the power cord and local regulations;
- Route the power cord so that people cannot trip over it. Do not let the power cord pass through sharp corners or hang in the air, and do not pinch cables. In addition, the cables must not be placed over high temperature objects and must be protected from oils and aggressive cleaning agents;
- Do not lift or pull on the device by the power cord. Do not pull the plug out of the socket by pulling on the power cord. Never touch the power cord or plug with wet hands! Never insert wet plugs into sockets!

5. 1. 4 Water conditions

Poor quality raw materials and poor water quality can damage the machine. Be sure to observe the following points:

- The water must be clean and contain no more than 100 mg of chlorine per liter;
- Do not add corrosive water to the coffee machine;
- Carbonate hardness must not exceed 5~6°dKH (German carbonate

hardness) or 8.9~10.7° fKH (French carbonate hardness) and the total hardness value must always be higher than the carbonate hardness;

- Minimum carbonate hardness is 5°dKH or 8.9°fKH. pH must be between 6.5~7;
- The water supply must be connected in accordance with the current regulations and the regulations of the country in which it is used. If the machine is connected to a newly installed water line, the water line and inlet hose must be rinsed thoroughly to prevent stains from entering the machine.

5. 2 First Run

Power connection: Take out the power cord and plug in the power.



Install the milk bottle: take it out of the box and fill it with enough milk, connect the plastic milk tube connector to the beverage outlet, and the metal milk tube connector to the milk bottle.



Filling coffee beans: Open the coffee bean container lid, add coffee beans and install the lid.



Fill water: Take out the water tank, and clean the inside of the tank. Then add pure water to the water tank until it is 80% full, and finally put it back.



Turn on the coffee machine: Press the power switch on the back of the machine as shown, and the coffee machine is connected to the power supply. Starts the machine and the screen displays the boot interface, it is ready to make drinks.



5.3 Turn the coffee on and off

Step 1: In the standby state, press and hold the circular button on the top of the coffee machine for 3 seconds; then operate according to the prompts on the coffee machine interface, and enter the soft-off state after the shutdown is completed.

(In soft-off state, press and hold the circular button for 3 seconds to restart the coffee machine.)



Step2: In soft-off state, press the power switch on the back of the coffee machine to completely cut off the power of the coffee machine. (Note: Do not directly cut off the power in the power-on state, so as not to cause damage to the machine.)



5.4 Disassembly and installation of the bean hopper

Removing the bean hopper: Hold both ends of the bean hopper with both hands (avoid touching the black part below the bean hopper) and rotate it counterclockwise until the arrow points to the unlocked position, and then take out the bean hopper upwards.



Install the bean hopper: put the bean hopper on the coffee machine installation place, make the arrow point to the unlock position, then hold the bean hopper with both hands (avoid touching the black part under the bean hopper) and rotate clockwise until the arrow points to the lock position.



6 Beverage making

6.1 Coffee

▶ For example: make a cup of Espresso.

Step 1: Tap on the "Espresso" drink or use the spin circle until espresso appears in the center of the screen;



Step 2: Click on espresso in the center of the screen;



Step 3: After adjusting the beverage parameters, click OK to start the coffee making;

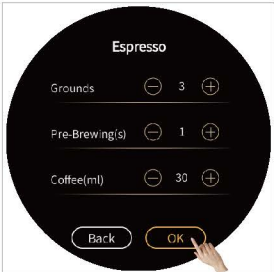

Step 4: During the process of making the drink..., click "Cancel" to stop the making immediately.



6.2 Milk Beverage

▶ For example: make a cup of "Cappuccino".

Step 1: Click on the "Cappuccino" drink or use the spinning circle until the cappuccino appears in the center of the screen;



Step 2: Click on Cappuccino in the center of the screen;



Step 3: After adjusting the beverage parameters, click OK to start the coffee making;



Step 4: During the process of making the drink..., click "Cancel" to stop the making immediately.

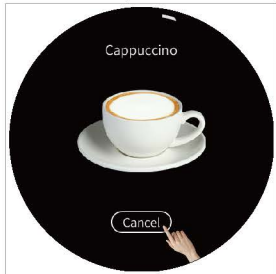

Step 2: Click on Hot water in the center of the screen;



Step 3: After adjusting the beverage parameters, click OK to start the coffee making;

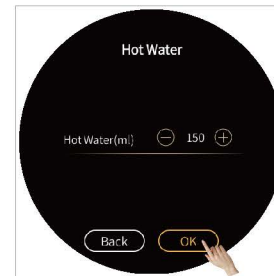

6.3 Hot water

▶ For example: make a cup of hot water.

Step 1: Click on the "Hot water" drink or use the spinning circle until the cappuccino appears in the center of the screen;



Step 4: During the process of making the drink..., click "Cancel" to stop the making immediately.



7 Cleaning and maintenance

7.1 Daily cleaning

▶ Daily cleaning operations needed to be performed daily.

7.1.1 Brewing system rapid rinse

Step 1: Click the settings icon at the bottom of the screen;



Step 2: Maintenance appears in the middle of the screen, click OK;



Step 3: Slide the center of the screen to the brewing system rapid rinse, click OK;

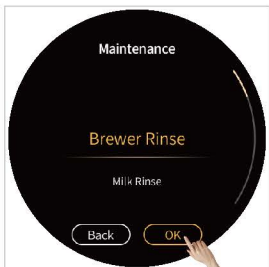

Step 4: Enter the brewer rapid rinse, click OK to perform the quick flushing of the brewing system.



√ The brewing system rapid rinse complete and automatically returns to the main interface

7.1.2 Milk system rapid rinse

Step 1: Click the settings icon at the bottom of the screen;



Step 2: Maintenance appears in the middle of the screen, click OK;



Step 3: Slide the center of the screen to the milk system rapid rinse, click OK;

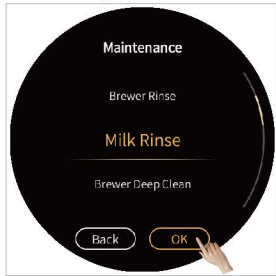

Step 4: Enter the milk rapid rinse, click OK to perform the quick flushing of the milk system.



The milk system rapid rinse complete and automatically returns to the main interface

7. 1. 3 Milk frother disassembly and cleaning

Step 1: Remove the milk tube as shown ;



Step 2: Squeeze the coffee outlet cover with hand, pull it slightly outwards, and then remove the coffee outlet cover firmly downwards;



Step 3: Pinch the milk frother with your fingers, and then pull down the milk frother firmly;



Step 4: Disassemble the milk frother, connector and other components, and take them under the faucet for cleaning;



Step 5: Put the rinsed milk frother part back into the coffee machine as shown in the picture;



Step 6: Install the coffee outlet cover and the milk tube back.



7.2 Regular maintenance

► Regular maintenance items that require the operator to follow the steps in the coffee machine cleaning instructions.

7.2.1 Brewing system deep clean

Step 1: Click the settings icon at the bottom of the screen;



Step 2: Maintenance appears in the middle of the screen, click OK;



Step 3: Slide the center of the screen to brewer deep clean, click OK;

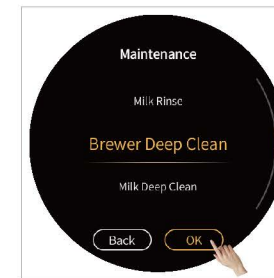

Step 4: Enter the brewer deep clean, click OK to perform the deep clean of the brwer system;



Step 5: Follow the instructions on the screen step by step to perform deep cleaning of the brewing system.

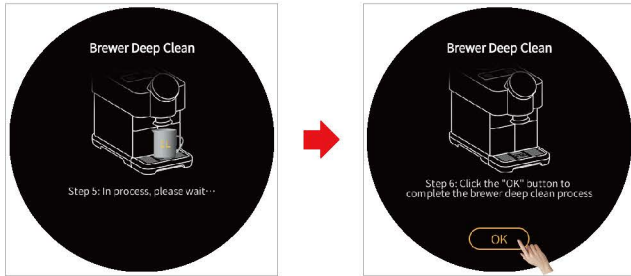

Step 3: Slide the center of the screen to milk deep clean, click OK;

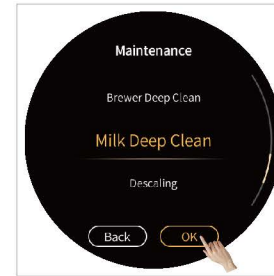

7. 2. 2 Milk deep clean

Step 1: Click the settings icon at the bottom of the screen;



Step 4: Enter the milk deep clean, click OK to perform the deep clean of the milk system;

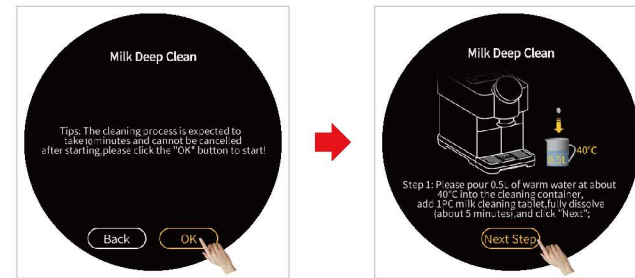

Step 2: Maintenance appears in the middle of the screen, click OK;

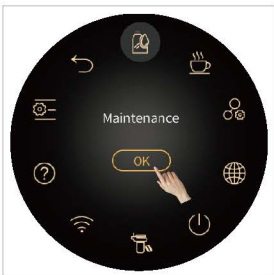

Step 5: Follow the instructions on the screen step by step to perform deep cleaning of the milk system.



8 Precautions for daily use and maintenance

- Please do not add water to the coffee bean hopper;
- During the operation of the coffee machine, please do not forcibly take out the grounds container, drip tray, water tanks, bean hopper and other components;
- The external water tank can only be filled with pure water at room temperature, please do not add hot water or ice water;
- It is recommended to use coffee beans with medium roast or medium dark roast and not too oily. It is not recommended to use dark roasted or charcoal roasted and very oily coffee beans;
- When the beverage flows out, please do not put your hand at the outlet of the coffee machine to avoid burns;
- When cleaning the machine, please do not use a brush or cleaning agent, so as not to damage the appearance of the coffee machine, please wipe it with a soft cloth dampened with water;
- When filling beans or water, please do not exceed the MAX line. If there is no MAX line, fill it with 8 points;
- During the coffee making process, self-checking and resetting process, and automatic cleaning process, please do not cut off the power supply;
- According to the height of the coffee cup, adjust the height of the coffee outlet appropriately to avoid the splashing of beverages such as coffee and hot water;
- When shutting down, please follow the correct steps: Please enter the shutdown interface of the screen, click "Power off", follow the screen prompts for operation, complete the screen and turn off the screen after a long press, then press the power switch behind the coffee machine to break off electricity. Do not press the power switch or pull the power plug directly;
- Every day after the machine is turned off and stopped for use, please empty the coffee grounds and waste water in the machine and clean it;
- In order to ensure the quality of coffee, it is recommended to clean the water tank and replace the water in the water tank every day;
- This product cannot be immersed in water for cleaning.

9 Trouble shooting and Handling

Error	Solutions
Water Tank Is Empty	<ol style="list-style-type: none"> 1. The water in the tank is already below the detection level; The water tank is not installed correctly and too far from the sensor; Water level sensor is broken; 2. Take out the tank and add water, make sure the water is not higher than the "Max" line marked on the tank; Check and reinstall the water tank; Replace a new sensor.
Grounds Container Is Full Up	<ol style="list-style-type: none"> 1. The grounds count in the grounds container reaches 10 pieces or is already full; 2. Pull out the drip tray, take out the grounds container, and empty the container.
Bean Hopper Empty	<ol style="list-style-type: none"> 1. Coffee bean hopper is empty; Beans sticks together; 2. Fill coffee beans to the bean box; Stir the beans in the bopper until they are loose.
Bean hopper is not well installed	<ol style="list-style-type: none"> 1. The bean hopper is not installed in place; the bean hopper sensor is damaged; the induction magnet of the bean hopper is lost or damaged; 2. Re -install the bean hopper; replace the new sensor; replace the new sensor magnet.
Drip Tray Is Not In Place	<ol style="list-style-type: none"> 1. Not well fixed; Sensor broken ; Magnet loosing or broken; 2. Replace the drip tray; Replace new sensor; Replace new magnet.
Drip tray is full up	<ol style="list-style-type: none"> 1. The waste water in the tray is full; Sensor is dirty; 2. Pull out and empty the tray; Check and clean up the sensor.
Environment Temp. Is Too Low	<ol style="list-style-type: none"> 1. The temperature of the environment is 0℃ or lower; 2. Please power on the machine when the temperature of environment is 10℃ ~40℃.
System lack of water	<ol style="list-style-type: none"> 1. Multiple systems are short of water, and hydration is unsuccessful; 2. After shutdown, restart the machine.
Lack of Water	<ol style="list-style-type: none"> 1. After the production of 3 cups in a row, if the system prompts that system lack of water and cannot be replenished normally, it needs to wait 10 minutes and try again. 2. The inlet of tank r is blocked. The tank is unfixed; The strainer of Brewer is blocked; The Flowmeter damages; 3. Check the way of water supply and tap "Fill Water"; Check the tank outlet and reinstall it in place; clean the strainer, reinstall and push the tank to the end ; Clean the strainer by Brewer Deep Clean with tablets or by disassembling; Replace a new Flowmeter; Switch off and restart the machine;
No Milk	<ol style="list-style-type: none"> 1. The milk box is empty; The pipe or outlet of steam is blocked; The pipe of steam is broken; The number of Air Intake is set too high. The Milk Frother is blocked; 2. Refill milk to the milk box; Do milk deep Rinse; Disassemble the cover of machine, check the pipe of steam; Set the number of Air Intake lower; Disassemble and clean the milk frother ; replace a new milk frother.

Error	Solutions
Pressure Overloaded	<ol style="list-style-type: none"> 1. The pipe or strainer of Brewer is blocked;Coffee Grounds from Grinder are too fine; The amount Coffee Grounds from Grinder are over the max capacity of Brewer;Air is coming into the Pump while coffee making; 2. Tap "Rinse" to rinse Brewer;Adjust the gear position of the coffee machine to clockwise. The bigger number represents coarser. Clean the Inlet of tank.
Brewer Check Up	<ol style="list-style-type: none"> 1. After a certain cups of coffee made, it will alarm;It will alarm at the 2000th cup, 7000 th cup, 17000th cup, 27000th cup... and so on. (every 10 thousand cups); 2. Follow the tips and enter service manual to do finish calibration; Follow the instruction of service manual.
Brewer Unit Deep Clean Required	<ol style="list-style-type: none"> 1. Reach the set value, it will alarm. Set in manual; The settled valve can be changed in the service manual; 2. Follow the tips and enter service manual to do deep clean; Follow the instructions of service manual.
Descaling Required	<ol style="list-style-type: none"> 1. Reach the set value, it will alarm. Set in manual; The settled valve can be changed in the service manual; 2. Follow the tips and enter service manual to do deep clean; Follow the instructions of service manual.
Water Leakage	<ol style="list-style-type: none"> 1. Water leaking inside the machine; 2. Disassemble the appearance of the machine and check the specific leaking location; replace the accessories at the leaking location.
No Coffee	<ol style="list-style-type: none"> 1. The coffee grounds are too fine;The amount coffee grounds from grinder are over the max capacity of brewer;The pipe or strainer of Brewer is blocked;The Brewer damages;The Strainer of inlet valve is blocked; 2. Adjust the gear position of the coffee machine to clockwise. The bigger number represents coarser;Do grounds calibration;Do brewer deep rinse with tablets;Re-fix the Brewer, or replace a new Brewer; Clean Strainer or replace a new one;
Brewer System Error	<ol style="list-style-type: none"> 1. Tap three times "brewer self-checking", prompts brewer system error; The brewer is blocked is stuck;The motor doesn't work; The brewer damages; Control Board damages; 2. Switch off the machine and restart;Disassemble the brewer , check and clean;Replace a new motor; Replace a new Brewer;Replace a new Control Board;
HMI Communication Error	<ol style="list-style-type: none"> 1. Main board and display board connection loose or damaged; Control software doesn't match with the HMI software;HMI PCB damages; Main Board damages; 2. Check the plugs on HMI PCB and reconnect;Upgrade Control software and HMI Software;Replace a new HMI PCB;Replace a new Main Board.
Thermo-block NTC Error	<ol style="list-style-type: none"> 1. Electronic fault between sensor and master;The temperature of the thermo-block exceeds 180 C ; 2. Replace the connectors of thermo-block;Replace the NTC sensor; Switch off and restart after 30 minutes;Replace thermo-block group.
Fail to switching on	<ol style="list-style-type: none"> 1. No power ;Voltage isn't high enough; Not Switched on; Power PCB damages; The fuse of Main Power is blown; 2. Check if the machine is connected with power; Connect the machine with acceptable power;Check if the machine is switched on; Replace a new Power PCB;Replace a new fuse.
Crash	<ol style="list-style-type: none"> 1. System stops unexpectedly; 2. Turn off the machine, wait for about 5 seconds, then turn it on again; upgrade the system program of the coffee machine.

10 Liability and Warranty

10.1 User Responsibilities

- The user must ensure that the safety device is regularly maintained and inspected by technical service personnel, its authorized personnel or other authorized personnel.
- Parts involving safety, such as safety valves, safety thermostats, water boilers, etc., are not allowed to be repaired. Said parts must be replaced!
- These measures are carried out by the customer service technicians or by the service partner when maintenance is performed.

10.2 Warranty and liability

- If personal injury or property damage is caused due to the following reasons, our company will not be liable for warranty and compensation:
 - The machine is not being used correctly as specified.
 - Incorrect installation, commissioning, operation, cleaning and maintenance and associated optional equipment.
 - Maintenance intervals not respected.
 - Continue to use this machine if safety devices and guards are damaged, incorrectly installed, or failed.
 - Failure to comply with the instructions in the instruction manual regarding the preservation, installation, operation, use and maintenance of the machine Safety Instructions.
 - The machine is not being used under normal conditions.
 - Repairs are not performed correctly.
 - Not use genuine parts.
 - Not using recommended cleaning agents.

- Damage caused by foreign objects, accident, vandalism and force majeure.
- Insert foreign objects into the machine or open the machine casing with foreign objects.
- The manufacturer assumes all possible liability for damages only if the prescribed service and maintenance intervals are observed and original spare parts ordered from the manufacturer or authorized suppliers are used.