

# manual

## kb90

The kb90 is tailored to suit the needs of the world's busiest coffee bar, making espresso preparation easier for baristas. La Marzocco, considering the needs of high volume cafes and their staff, has redesigned the portafilter system to reduce the wrist strain of the user. By focusing on simplifying the fine motions, the machine is able to shave seconds off of the time required to make each drink. The kb90 sets a new standard in high volume cafe performance for La Marzocco.



**la marzocco**

handmade in florence

# kb90

Operating Manual V1.0 - 09/2018  
MAN.22.1

## Chapters

1. General Warnings and Safety Specifications	page 3
2. Definition of Available Models	page 7
3. Installation	page 10
4. Machine Operation and Coffee Preparation	page 16
5. Dispensing Steam and Hot Water	page 19
6. Maintenance and Periodic Cleaning Operations	page 20
7. De-commissioning and Demolition	page 23
8. Mandatory Maintenance and Check-up Operations	page 24
9. Precision Scale	page 25
10. Straight-in	page 27
11. Software Programming Guide	page 28



**la marzocco**

handmade in florence

La Marzocco S.r.l.

Via La Torre 14/H  
Località La Torre  
50038 Scarperia e San Piero  
(Firenze) - ITALIA

[www.lamarzocco.com](http://www.lamarzocco.com)  
[info@lamarzocco.com](mailto:info@lamarzocco.com)

T: +39 055 849 191  
F: +39 055 849 1990

certifications available:



## 1. General Warnings and Safety Specifications

### WARNING

This machine is for professional use only and should be installed in locations where its use and maintenance is restricted to trained personnel. Children are forbidden to operate or play with the machine.

### WARNING

The Coffee machine must be placed in a horizontal position on a counter higher than 80 cm from the ground.

### WARNING

This machine is not suitable for outdoor use. Jets of water should not be used to clean the machine, nor should it be placed where water jets are used.

### CAUTION

As already mentioned in the preceding notes, the manufacturer shall not be held responsible for damage to objects, animals and/or people whenever the machine has not been installed according to the instructions contained in this manual, and is not used to do what it was designed for (i.e. preparing coffee and hot drinks).

#### 1) Important safeguards

- The weighted sound pressure level of the machine is lower than 70dBA.
- Use, cleaning and maintenance of this coffee machine are realized by people (including children more than 8

years of age) with reduced physical, sensory or mental capabilities, or lack of experience and knowledge, as long as they have been given supervision or instructions concerning the use of the appliance by a person responsible for their safety and if they understand dangers.

- Children should be supervised to ensure that they do not play with the appliance.
- Keep the appliance and its cord out of the reach of children less than 8 years of age.

2) This operating manual is an integral and essential part of the product and

must be supplied to users. Users are asked to read the enclosed warnings and cautions carefully, as they provide valuable information concerning safety during installation, operation and maintenance. This manual must be kept in a safe place and be available for consultation to new and experienced users alike.

**3)** Ensure product's integrity by inspecting the packaging, making sure it presents no signs of damage which might have affected the enclosed machine.

**4)** Check the machine's integrity after having carefully removed the packaging.

**Note: In case of doubt, do not go**

**on any further and contact your dealer or retailer immediately. They will send out specialized personnel authorized to perform service on the espresso machine.**

**5)** Packaging (boxes, plastic bags, foam parts and whatever else) must not be left around within easy reach of children, due to the potential danger it represents, nor be discarded in the environment.

**6)** Check to see that data on the rating plate corresponds to those of the main electrical supply which the machine will be hooked up to.

**7)** The equipment must be installed to comply with the applicable federal, state or local electrical and plumbing

codes. The installation also must comply to the manufacturer's instructions, and must be performed by qualified and authorized personnel.

**8)** Incorrect installation may cause for injury/damages to people, animals or objects, for which the manufacturer shall not be held responsible.

**9)** Safe electrical operation of this device will be achieved only when the connection to the power outlet has been completed correctly and in observance of all local, national, and international electrical codes and safety regulations, and particularly by grounding the unit. Make sure grounding has

been done properly as it represents a fundamental safety requirement. Ensure qualified personnel check such connection.

**10)** Furthermore, you must ensure that the capacity of the available electrical system is suitable for the maximum power consumption indicated on the espresso machine.

**11)** We do not recommend using adapters, multiple plugs and/or extension cords. If you cannot avoid using them, make sure that they are exclusively of the kind which conforms to local, national, and international electrical codes and safety regulations, being careful not to exceed the power and current ratings

indicated on such adapters and extension cords.

**12)** This device must be used exclusively for the functions it has been designed and built for. Any other application is inappropriate and dangerous.

**The manufacturer shall not be held responsible for any damages caused by improper and/or irrational use.**

This machine should not be installed in kitchens.

**13)** Using any electrical device requires that certain fundamental rules be observed. In particular:

- do not touch the device with wet or humid hands and feet;
- do not use the device while having no shoes on your feet;

- do not use extension cords in bath or shower rooms;
- do not unplug the device from the power outlet by pulling on the power supply cable;
- do not expose the device to atmospheric agents (rain, sun, etc.);
- do not allow children or untrained people to use this device;
- do not clean the control panel with a wet cloth since it is not watertight.

**14)** Before carrying out any maintenance and/or cleaning operations, turn the main switch, which is located on the front left of the machine, to the “0” or “OFF” position, and disconnect the machine from the electrical network

by unplugging the cord or by switching off the relative circuit breaker. For any cleaning operation, follow exclusively the instructions contained in this manual.

**15)** In case the machine is operating in a faulty manner or breaks down, disconnect it from the electrical network (as described in the preceding point) and close the water supply valve. Do not attempt to repair it. Contact a qualified and authorized professional to perform any repair. Any repairs must be performed exclusively by the manufacturer or by an authorized centre using only original parts. Non compliance with the above could compromise the safe operation of the machine.

**16)** You should plan to make use of an omnipolar connector during installation, as required by local, national, and international electrical codes and regulations.

**17)** In order to avoid dangerous overheating problems, it is recommended that the power supply cable be fully unfurled.

**18)** Do not obstruct air intake and exhaust grilles and, in particular, do not cover the cup warmer tray with cloths or other items.

**19)** The machine's power supply cable must not be replaced by users. In case the power supply cable becomes damaged, shut off the machine and disconnect the

machine from the electrical network by switching off the relative circuit breaker and close off the water supply; to replace the power supply cord, contact qualified professionals exclusively.

**20) Common Dimensions, Weights, and Features**

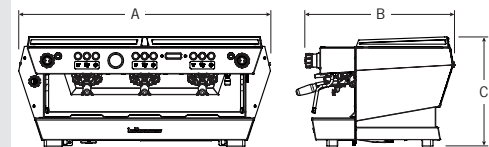

kb90	2 groups	3 groups
A [mm]	810	1050
B [mm]	620	620
C [mm]	448	448
WEIGHT [kg]	77	101

## 2. Definition of Available Models

This operating manual refers exclusively to the following models, of our own manufacture:  
kb90 model 2 and 3 groups

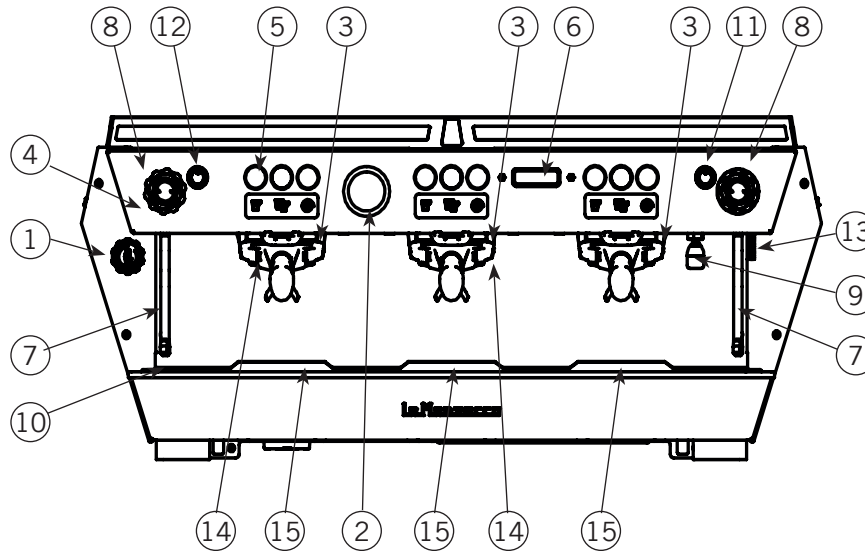

### Legend

- 1 Main Switch
- 2 Pressure Gauge (Steam & Brew water)
- 3 Brew Groups
- 4 Control Panel
- 5 Group #1 Keypad
- 6 Digital Display
- 7 Steam Wand
- 8 Steam Knob
- 9 Hot Water dispense nozzle
- 10 Removable Drain Tray
- 11 Hot Water Button
- 12 Cup Warmer Button
- 13 Hot Water Mix Valve
- 14 Straight-in
- 15 Precision Scale

Fig. 1 - Model with 2 or 3 groups

For additional information on electronics, keypads, and software programming, please see the section entitled Software Programming your Espresso Machine.

### 1) General Description

The machine is built in 2 and 3 coffee group versions and is essentially composed of the following parts:

- Steam Boiler (produces steam and hot water);
- Coffee (“saturated”) boiler;
- Brewing groups;
- Exterior Cover;
- Water pump.

### 2) Description of the various parts

#### • Steam Boiler

The Steam Boiler consists of a cylindrical tank, of varying length according to the number of coffee groups, which is made of AISI 300 series stainless steel. Each unit is subjected to a hydraulic test, at a pressure of 6 bar, and has an operating pressure of 1.3-1.5 bar. The following is a list of effective volumes and power ratings according to the number of groups installed:

2 groups	7,0 liters	3000 Watts
3 groups	11 liters	4000 Watts

Covers are welded at either end of the cylindrical tank and on one of them there is a housing for the water heating element, which allows the steam boiler to reach operating pressure within approximately 25

minutes. Operating pressure is maintained by temperature probe and PID controller. The steam boiler has various fittings used for safety devices, for supplying hot water and steam, and for the heating element.

Composed of AISI 300 series stainless steel tube. Heating is accomplished through an immersion-type plated heating element.

- Operating pressure of 1.3-1.5 bar, controlled automatically through a pressure switch or a temperature probe, adjusted to open the heating element supply circuit at 1.5 bar and close it at 1.3 bar.
- The pressure is displayed by means of a pressure gauge with a scale of 0 to 2 bar.
- Safety device, based on an expansion type mechanical valve, with counter-acting spring adjusted to 1.8 bar.
- Testing: hydraulic test at 4.5 bar performed on ready-to-use small boilers, at our factory.

#### • Coffee Boiler

The Coffee Boiler consists of a cylindrical tank made of AISI 300 series stainless steel. One each group (hot water generator for brewing coffee).

Each unit is subject to a hydraulic test, at a pressure of 18 bar, and has an

operating pressure of 9 bar. The following is a list of effective volume and power ratings according to the number of groups installed:

2 groups	2 x 1,3 liters	2 x 800 Watts
3 groups	3 x 1,3 liters	3 x 800 Watts

Covers are installed at either end of the cylindrical tank and on one of them there is housing for the water heating elements. The temperature of the coffee boiler is maintained by an electronic temperature controller (PID capable) with an accuracy of 0.2°C. The brewing groups are installed on the boiler.

Composed of an AISI 300 series stainless steel tube. Heating is accomplished through an immersion-type plated heating element.

- Operating temperature 95°C (adjustable), controlled automatically by an electronic temperature controller with an accuracy of 0.2 °C. Operating pressure of 9 bar.
- Pressure is displayed through a pressure gauge with a scale from 0 to 18 bar.
- Safety device, based on an expansion type mechanical valve, with counteracting spring adjusted to 13 bar.
- Testing: Hydraulic test at 18 bar performed on ready-to-use small boilers, at our factory.



- **Brewing groups**

They consist of a precision casting made of stainless steel. The brewing group accepts the portafilter used to hold the ground coffee; the espresso flows through the brewing group, through the portafilter basket, through the portafilter spout, and into the cup(s) after the brewing button has been pressed.

- **Exterior cover**

The exterior consists of painted and stainless sheet steel panels. To provide good aesthetics, to optimize ergonomics for the operator and to reduce the chance of damage to a minimum.

- **Water pump**

The rotary vane pump, is installed on the water supply tubing and is set up to operate anytime the coffee groups are activated, and through an autofill system whenever the water boiler needs to be replenished.

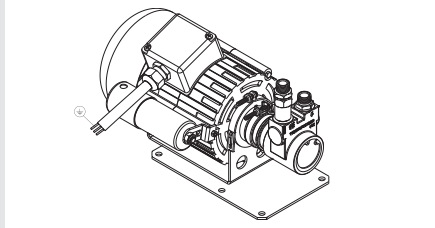

- **Machine CE plate:**

			
<b>la marzocco</b> <small>handmade in firenze</small>			
SERIE	KB90	MODEL	3AV
V	220-240	W	7733
STEAM BOILER OP	0.15 MPa	S/N	KB000000
COFFEE BOILER LITERS	1.3x3	A	33.8
MAX WATER INLET P	0.8 MPa	DATE	01/18
		Hz	50/60
		MAX PUMP P	0.9 MPa
		STEAM BOILER LITERS	11.8
ESPRESSO MACHINE		<a href="http://www.lamarzocco.com">www.lamarzocco.com</a>	
MADE IN ITALY			

- **Machine ETL plate:**

		<b>la marzocco</b> <small>handmade in firenze</small>	
MODEL	KB90 3AV	SERIAL No.	KB000000
DATE	01/18	AMPS	29-33
VOLTS	208 - 240	Hz	60
SINGLE PHASE			
MAX. OPERATING PRESSURE: STEAM		22 PSI	WATER 161 PSI
ESPRESSO MACHINE		<a href="http://www.lamarzocco.com">www.lamarzocco.com</a>	
MADE IN ITALY			

### 3. Installation

MODEL/SERIES	GROUP	V/Hz	RATED POWER (W)	RATED INPUT (A)	COFFEE BOILER WATTAGE	STEAM BOILER WATTAGE	TOTAL WATTAGE	POWER CORD SIZE (mm <sup>2</sup> )
KB90	2GR	AC220-240V/60Hz AC208-240/60H	5666 5360	24.6 21-24	1600 1600	3000 3000	5666 5360	SEE ELECTRICAL CONNECTIONS FOR DETAILS
	3GR	AC220-240V/60Hz AC208-240/60Hz	7783 7324	33.8 29-33	2400 2400	4000 4000	7783 7324	

<p><b>3 X WIRES</b> 1 X BLUE (NEUTRAL) 220V 1 X BROWN (PHASE) 1 X YELLOW &amp; GREEN (GROUND)</p> 	<p><b>POWER CORD:-</b> <b>5 X WIRES</b> 1 X BROWN (PHASE) 1 X BLUE (NEUTRAL) 380V 1 X GRAY (PHASE) 1 X YELLOW &amp; GREEN (GROUND) 1 X BLACK (PHASE)</p> 	<p><b>WARNING</b></p> <p>THE DETAILS ON THE LEFT DESCRIBE HOW TO CONNECT EACH WIRE TO THE PLUG. RESPECT ALSO THE LOCAL SAFETY REGULATIONS.</p>
---	--	--

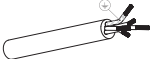
**WARNING**

The machine is intended to be permanently connected to fixed wiring, and it is mandatory that a residual current device (RCD) with a rated residual operating current not exceeding 30mA is installed.

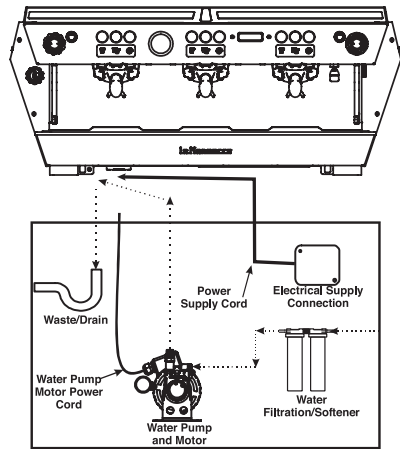

Fig. 2 - Installation Guide

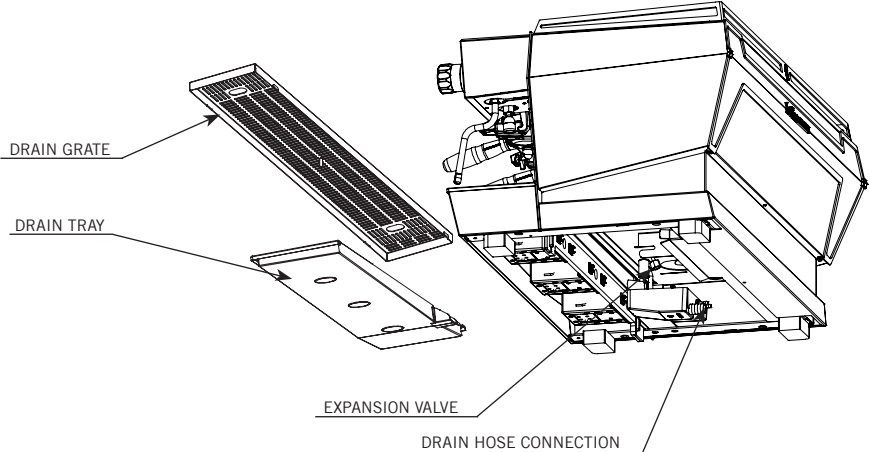

Fig. 3 - Installation Nomenclature

**▲ WARNING ▲**  
At each installation, the machine should be equipped with a new set of tubes for plumbing and related gaskets.

**▲ WARNING ▲**  
Water pressure supply must be between 0,2 and 0,6 MPa if sufficient pressure is not available we suggest that an additional water supply system is used.

**▲ WARNING ▲**  
Before making any electrical connections make sure that the two strain relief connectors are firmly secured to the body of the machine in order to prevent inadvertent stress on the power cables.

**▲ WARNING ▲**  
This machine should not be installed in kitchens.

**▲ WARNING ▲**  
Hazardous voltage disconnect from power supply before servicing.

**▲ WARNING ▲**  
The motor pump must be situated close to the machine in an accessible place for maintenance but not for accidental interference and where there is an optimal air circulation.

**▲ WARNING ▲**  
The manufacturer declines any responsibility for any event leading to liability suits whenever grounding has not been completed according to current local, national, and international regulations and electrical codes, or other electrical parts have been connected improperly.

**▲ WARNING ▲**  
This appliance is not intended for use by persons (including children) with reduced physical, sensory or mental capabilities, or with lack of experience and knowledge, unless they have been given supervision or instruction concerning the use of the appliance by a person responsible for their safety.

**▲ WARNING ▲**  
- U.S.A. and CANADA only - Do not connect to a circuit operating at more than 150V to ground on each leg.

**▲ WARNING ▲**  
This machine is not suitable for outdoor use. Jets of water should not be used to clean the machine, nor should it be placed where water jets are used.

**WARNING**

The Coffee Boiler and Steam Boiler contain water at elevated temperature. Water temperature over 125°F / 52°C can cause severe burns instantly or death from scalding (Coffee Boiler 207°F/97°C - Steam Boiler 256°F / 124°C)

**WARNING**

Replace fuses with the same size, type and rating F1 = 2A, 250V

**WARNING**

In order to prevent cracks or leakage: do not store or install the Coffee machine in places where in boiler or hydraulicsystem to freeze.

**Note:**

- The drinking water mains valve and the circuit breakers for the electrical system need to be located in the most convenient position for the operator to access them easily and quickly.
- The machine should be placed on a flat counter and must be placed in settings with the following temperatures:  
Minimum room temperature: 5°C/41°F;  
Maximum room temperature: 32°C/89°F.
- If the machine has been temporarily housed in settings with a room temperature of less 0°C/32°F, the machine must be placed in a warmer environment in order to gradually defrost the hydraulic system prior to use.
- Water pressure supply must be between 0,2 and 0,6 MPa.
- This machine complies with the standard 61000-3-11, the impedance at the supply interface must be  $Z_{max}=0.03 \Omega$ .

**Water specifications table**

		<b>Min.</b>	<b>Max.</b>
T.D.S.	ppm	90	150
Total Hardness	ppm	70	100
Total Iron (Fe <sup>+2</sup> /Fe <sup>+3</sup> )	ppm	0	0,02
Free Chlorine (Cl <sub>2</sub> )	ppm	0	0,05
Total Chlorine (Cl <sub>2</sub> )	ppm	0	0,1
pH	value	6,5	8,5
Alkalinity	ppm	40	80
Chloride (Cl <sup>-</sup> )	ppm	not more	50

**N.B.:** Test water quality (the warranty is void if water parameters are not within the range specified in the section “installation”)

## 1) Installation on the counter

The image below shows the recommended method to drill the hole on the counter.

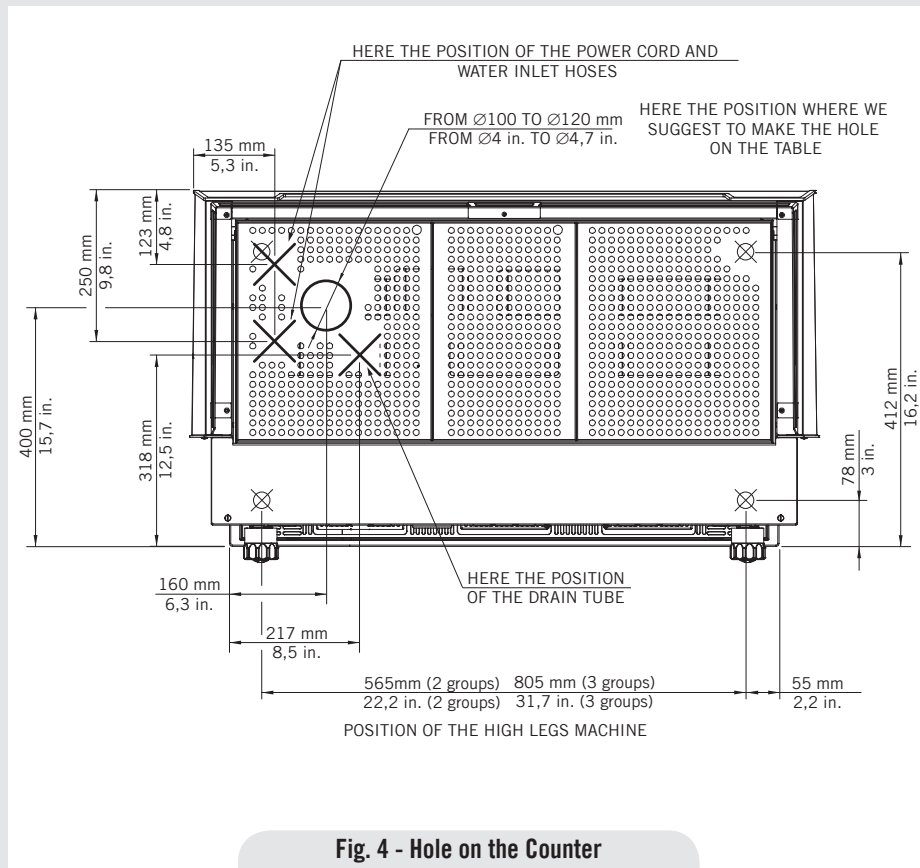

Fig. 4 - Hole on the Counter

## 2) Accessories

Check the package to make sure that the following accessories are included:

- a number of 1-dose and 2-dose portafilters corresponding to the number of groups;
- replacement 1-dose and 2-dose filters (one of each);
- 1 tamper;
- 1 blind filter;
- cleaning detergent, for the groups;
- 3 stainless steel braided hoses for water connections;
- 1,5 mt of reinforced plastic tubing for drainage;
- 1 hose clamp.

In order to proceed with installation, it is necessary that the following are available:

- Pipes carrying drinking water with a 3/8" G (BSP) end connection; (3/8" Compression for USA and Canada)
- Electrical Supply according to the specification of the espresso machine purchased:
- Single/Three phase 220VAC - 50/60 Hz electrical connection with ground, protected socket and approved interlock switch
- Single phase 200VAC - 50/60 Hz electrical connection with ground, protected socket and approved interlock switch

- Three-phase, 380VAC - 50 Hz electrical connection with neutral + ground, near the bench on which the machine is installed and terminating in a suitable protected fivepole socket equipped with an approved interlock switch
- Waste water drain system.

### 3) Water test kit

In order to enable you to check if your water supply is within the suggested ranges, La Marzocco machines will be equipped with two units of a quick water test kit (see image below) including 6 test-strips and instruction cards.

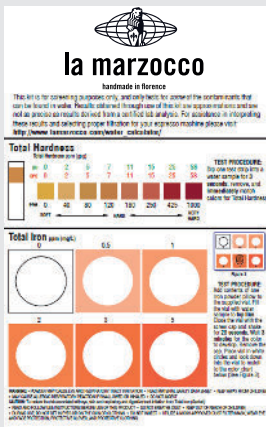

The parameters that you can measure are Total Hardness, Total Iron, Free Chlorine, Total Chlorine, pH & Total Alkalinity, Chlorides.

Ideally, you should perform a test on the water BEFORE the water treatment system and again AFTER the water system in order to verify if this is actually matching our suggested ranges.

Once the test has been performed, learn which treatment system is most appropriate for your particular water supply by filling out the online water calculator on our website: LA MARZOCCO WATER CALCULATOR ([http://www.lamarzocco.com/water\\_calculator/](http://www.lamarzocco.com/water_calculator/)).

### 4) Water supply connection

In order to connect the machine up to the water mains proceed according to the indications given in the chapter about Installation and in compliance with any local/national safety standards of the location in which the machine is being installed. The equipment is to be installed with adequate backflow protection to comply with applicable federal, state, and local codes.

To guarantee a correct and safe functioning of the machine and to maintain an adequate performance level and a high quality of the beverages being brewed it is important that the incoming water be of a hardness greater than 7°f (70ppm, 4°d) and less than 10°f (100ppm, 6°d), pH should be between 6.5 and 8.5 and the quantity of chlorides be less than 50mg/l. Respecting these values

allows the machine to operate at maximum efficiency. If these parameters are not present, a specific filtration device should be installed, while always adhering to the local national standards in place regarding potable water.

Then connect the inlet of the water filter/softener (if present) to the drinking water supply using one of the supplied stainless steel braided hoses. Before connecting the filter to the water pump, flush the water supply line and the filtration system in order to eliminate any residual particles which could otherwise get stuck in taps or valves thus preventing them from working properly. Connect the water supply connection of the espresso machine to the water pump outlet using one of the supplied stainless steel braided hoses. Then connect the water pump inlet to the water filter/softener outlet (if present).

**Note:** The water pump is a differential pressure volumetric pump and has been designed to be used exclusively with cold water. Make sure that water is always present while the pump is operating, otherwise air can be introduced into the brew boiler causing an undesirable condition and the pump can be damaged.

### 5) Electrical connections

#### a) Power supply cord

- This is the main power supply cable

that provides power to the entire espresso machine. There are different types of cable based upon the electrical requirements of the espresso machine purchased:

- 200/220VAC 1 Phase 3-core cable with 4/6/10mm<sup>2</sup> cross section or AWG 12/10/8 for 2,3 4 group versions, secured to espresso machine via a strain relief connector
- 220VAC 3 Phase 4-core cable with 4 mm<sup>2</sup> cross section for 2, 3 and 4 group versions, secured to espresso machine via a strain relief connector
- 380 VAC 3 Phase 5-core cable with 2.5mm<sup>2</sup> cross section for 2, 3 and 4 group versions, secured to espresso machine via a strain relief connector.

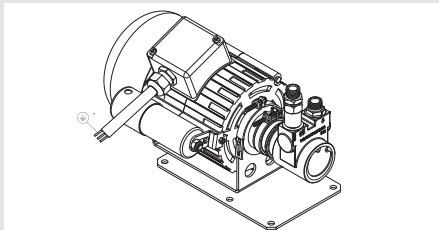

#### b) Water pump motor power cord

This is the power supply for the water pump motor. The internal electronics will switch the pump motor on when needed.

- 3-core cable with 1.5 mm<sup>2</sup> cross section or 3-core AWG 16 (for UL version) secured to espresso machine via a strain relief connector.

#### c) Quick connection between the water pump and the espresso coffee machine

The electrical connection must be made through the use of the connectors, as shown in the following figures:

- View of the connectors;

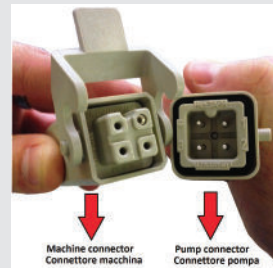

- Cable connection;

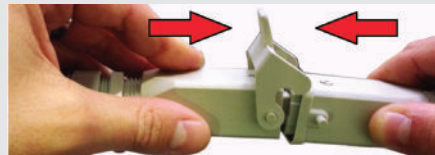

- Cable tightening;



#### 6) Waste water drain connection

The espresso machine drain is to be connected by means of the included reinforced plastic tubing. Connect one end of the reinforced plastic tubing to the drain hose connection on the left side of the espresso machine, secure with included hose clamp. Connect the other end to a suitable waste water collection system.

In case such a system is not available, drained liquids may be collected in a suitable bucket and any necessary drain pipe extensions shall be made using steel-lined PVC tubing and suitable hose clamps.

## 4. Machine Operation and Coffee Preparation

### CAUTION

Never remove the filter holder when water is being delivered. This operation can be extremely dangerous since the high pressure built-up inside the blind filter would spray out hot and slightly caustic water, which may cause severe burns. The Coffee Boiler contains water at elevated temperature. Water temperature over 125°F / 52°C can cause severe burns instantly or death from scalding.

### WARNING

The machine must not be dipped in, nor splashed with, water in order to clean it. For cleaning operations, please follow the instructions listed below very carefully.

### WARNING

This machine is designed only for preparing coffee and hot drinks.

#### IMPORTANT

To improve the flavor of the espresso, the temperature of the water in the coffee boiler and therefore of the groups may eventually be raised or lowered via the digital display (please consult the Software Programming Manual for detailed instructions).

#### 1) Starting the espresso machine

##### a) Filling the boilers with water

Once the installation procedures have been completed, it is necessary to fill the boiler tanks with water. Complete the following procedure to properly fill the boiler tanks:

##### • Coffee boiler

The water flows inside the coffee boiler directly, as soon as the water system and water filter/softener taps (if present) are opened. Since the inflow of water will compress the air in the boiler it will be necessary to remove or “bleed” the air from the coffee boiler. All air must be removed in order to completely “saturate” the coffee boiler/group assemblies. To remove the air from the boiler, “bleed the groups”, it will be necessary to remove the

group cover from the top of the machine. First remove the group tray from the top of the machine exposing the cup tray. Remove the screws securing the group cover and then remove it. Once removed the top of the groups will be exposed. Loosen the bleed screws one at a time (see fig.5) to allow air to escape until water flows from below the screw head.

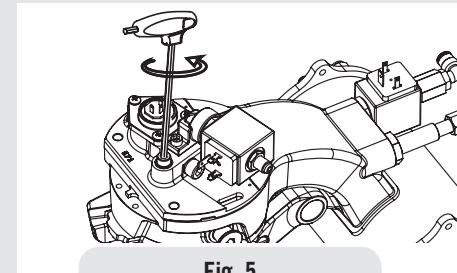

Fig. 5

Tighten the screw to stop the water from flowing. Over tightening can cause damage to the sealing washer and the group cover. Repeat this procedure for all groups. Once all air is removed from the coffee boiler, reinstall the group cover by following the removal instructions in reverse.

##### • Steam boiler

Turn the main switch (item 1 in Fig. 1) to position “1” or ON, the automatic steam boiler level gauge will be switched on, activating the auto-fill solenoid valve and the motor pump. This will fill the steam



boiler to a predetermined level and will shut off when full.

**Note:** It may happen that the air inside the steam boiler builds up pressure (which may be detected through the pressure gauge - item 2, fig. 1) when the water is allowed to flow in; this “false” pressure must be eliminated by opening the steam valves (item 8, Fig. 1).

#### b) Turning the espresso machine on

Once you have completed these procedures, check the display. Press enter to confirm that the preceding procedures are complete.

The installation is now complete and the espresso machine should be heating to the operating temperatures.

#### 2) Waiting for the espresso machine to heat to operating temperature

During this time, it may happen that the pointer of the coffee boiler pressure gauge reaches as high as 14-15 bar. This may happen anytime that the heating element is in the on condition. In this case it is necessary to adjust the expansion valve (Fig. 3) in such a way that the pressure may never exceed 11-12 bar. In normal operating conditions, the coffee boiler pressure gauge can read anywhere from 0-12 bar.

When brewing, the pressure should be set to 9 bar.

When the steam boiler reaches operating

temperature, the light on the Hot water dispense button will light.

When the espresso machine is ready to operate all lights on the keypads will light.

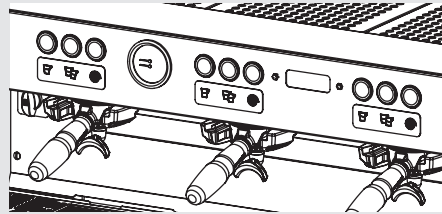

#### 3) Brewing after first installation

Once the first installation procedures are finished, before proceeding with brewing coffee, hot water and steam, please follow these steps:

- Engage the portafilters by inserting them into each group, brew water through each group for at least two minutes.
- Being careful to avoid burns, turn on each steam wand for at least one minute.
- Turn on the hot water valve for the time necessary to allow the following quantities of water to be brewed:

At least 1 liter for a 1/2 group machine

At least 2 liters for a 3 group machine

#### 4) Installing the portafilters

Install the portafilter(s) by inserting them into the group and lift the portafilter knob rotating it from top to bottom until the stop position is reached. When the portafilters are inserted properly, you can press any of brew buttons to start the flow of water

through the portafilter. You should allow hot water to pass through the empty portafilter(s) for a few seconds each time, in order to pre-heat the portafilter.

**Note:** It is important to leave the portafilters installed in the espresso machine when not in use. The portafilter must remain heated for the brew process to function correctly.

#### 5) Water pump

Whenever you are brewing coffee, and you can adjust the pump pressure by turning the by-pass screw (below the plug located on the side to which the pump power supply is connected) clockwise to increase and counter-clockwise to reduce pressure. Adjust pressure only when at least one group is brewing coffee.

**Note:** When the heating element in the coffee boiler is energized, the water will expand increasing the start-up pressure. Once the maximum pressure is reached, the expansion (safety) valve should start working by discharging a few drops of water, in order to prevent such pressure from exceeding 11-12 bar.

In case the pressure exceeds 12 bar, you must adjust the expansion valve by unscrewing the cap slightly. If this is not sufficient, remove the valve and clear away any calcium deposits. This remedy is valid also in case the valve remains open in the drain position (i.e. the pressure cannot increase to 8 bar approx.).

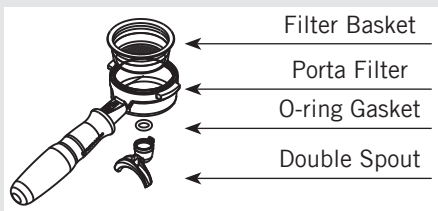

### 6) Brewing coffee

It is now possible to remove one of the portafilters to make an espresso beverage. Place some ground coffee in the filter itself: 1 dose (approximately 6-7 g) for the small filter, 2 doses (2 approximately 12-15 g) for the larger filter. Press down on the ground coffee with the supplied tamper and install the filter holder up again to the bottom of the group and then press a button to begin the brewing process.

**Note:** Some baristas believe it is important to press the brewing button prior to installing the portafilter to allow the water to flush any remaining coffee oils and particles from the group. Some also flush just after brewing coffee for the same reason. Please experiment to find the best possible procedure for you.

### 7) Controlling the brew process using volumetric programming

This espresso machine allows the volumetric programming of each of the first two buttons on each group (numbered left to right). Please consult the

Software Programming Manual for further instructions.

### 8) General notes for coffee preparation

The portafilters must remain heated since they are at the lowest position of the group itself, and they are partially isolated due to the rubber gasket between them. This can be accomplished by leaving the portafilters installed in the machine when not in use. The portafilters may also be actively heated. This procedure may be carried out by brewing some hot water through the portafilter then turning off the water flow, before making coffee.

It is important to remember that coffee left over in the filters must be removed only when you need to prepare another cup, and only at that time should you place a new dose of ground coffee in the filter.

The size of the coffee granules is extremely important in preparing a good cup of coffee, other than the type of coffee mix used, quite obviously. The ideal grinding can be determined by making various coffees using the amount of ground coffee that you would normally use for each cup (we recommend at least 6-7g). The best grinding is that which allows coffee to flow out from the filter holder spouts neither too slowly (drop by drop) nor too quickly (quick light brown flow). A general rule is that a double dose should dispense approximately 25cc or 2 fluid oz. of espresso in approximately 25 seconds.

### 9) Cup Warmer

Press Cup Warmer Button for enabled or disabled the cup warmer. This function work in two modes continuous or timed (see the Software Programming Manual for further instructions).



### 10) Autoclean and Autopurge

If the autoclean function is enabled in the menu, steam will be delivered by the group with a delay of 2 seconds form portafilter removal.

If the autopurge function is enabled in the menu, hot water will be delivered by the group with a delay of 2 seconds form portafilter removal.

If the autoclean and autopurge functions are both enabled in the menu, steam and then hot water will be delivered by the group with a delay of 2 seconds form portafilter removal.

## 5. Dispensing Steam and Hot Water

### 1) Steaming milk or other liquids

In order to allow for any condensed water in the wand to be released ALWAYS allow some steam to be discharged by turning on the valve before inserting the steam wand into the pitcher of liquid to be heated.

Dip one of the 2 steam wands (part 7, fig. 1) which are connected to the steam valve, into the liquid to be heated, turn the steam knob (part 8, fig. 1) gradually until steam comes out at the end of the wand. The steam will transfer heat to the liquid raising its temperature up to boiling point. Be careful not to allow liquid to overflow in order to avoid severe burns.

In order to prevent the heated liquid from being sucked back into the steam boiler it is recommended before using the wand that you purge the steam valve and steam wand by opening the valve for a few seconds to allow steam to escape to the atmosphere from the end of the steam wand. Failure to do so can cause the heated liquid to transfer from the heated liquid container to the steam boiler (via vacuum created from cooling parts). This condition is undesirable and can cause contamination in the steam boiler. After use remember to purge the wand by opening the steam valve for a few seconds, and then clean the outside of the wand

itself with an appropriate cloth.

In order to prepare milk for making cappuccino with the right amount of foam, go through the following steps:

- After purging the steam wand place the container half-full of milk underneath, carefully open the steam valve and raise the container so as to bring the wand end to a point just below the surface of the milk; at this point, move the container up and down just enough to dip the nozzle end in and out of the milk until you get the right amount of foam, bring the temperature of the milk almost up to 149/158°F or 65/70°C. You can then pour this milk into a cup containing warm espresso and you will end up with a fresh cup of cappuccino.

### 2) Preparing hot water and other hot drinks

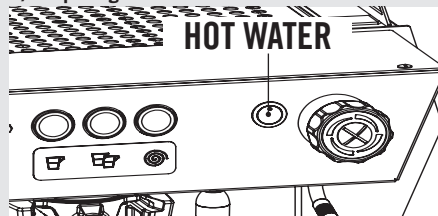

You may dispense hot water by using the fixed nozzle (item 9 fig 1). To dispense hot water, press the hot water button on the right most group.

This button commands the hot water delivery.

The volume of water delivered may be adjusted via the display (see the Software Programming Manual for further instructions). The temperature of the water dispensed may be adjusted by adjusting the mixing valve under the right side cover of the espresso machine. (only on the models of espresso machine equipped with this accessory)



## 6. Maintenance and Periodic Cleaning Operations

**▲ WARNING ▲**

If the above-mentioned instructions are not adhered to the manufacturer cannot be held responsible for damage to persons or things.

**▲ WARNING ▲**

In order to prevent cracks or leakage: do not store or install the coffee machine in places where temperature may cause water in boiler or hydraulic system to freeze.

**▲ WARNING ▲**

The machine is intended to be permanently connected to fixed wiring, and it is advisable that a residual current device (RCD) with a rated residual operating current not exceeding 30mA is installed.

**▲ WARNING ▲**

The machine must be installed so that qualified technical personnel can easily access it for eventual maintenance.

**▲ WARNING ▲**

The machine must not be dipped in, nor splashed with, water in order to clean it. For cleaning operations, please follow the instructions listed below very carefully.

**▲ WARNING ▲**

Do not remove the filter holder while relative group is brewing hot liquids.

The Coffee Boiler contains water at elevated temperature. Water temperature over 125°F / 52°C can cause severe burns instantly or death from scalding.

**▲ WARNING ▲**

This machine is for professional use only and should be installed in locations where its use and maintenance is restricted to trained personnel.

**▲ WARNING ▲**

Jets of water should not be used to clean the machine, nor should it be placed where water jets are used.

### 1) Cleaning groups and drain wells

- Put a tablespoon of detergent powder for coffee machines into the blind filter, supplied with the machine, and tighten it onto the group you want to clean by using a normal filter holder.

- Activate the automating rinsing (backflushing) routine (see the Software Programming Manual for more detailed instructions).

- Rinse the group using a normal filter, by running hot water through it several times

## 2) Cleaning filters

- Put 2 or 3 teaspoons of detergent powder for coffee machines in about 1/2 a litre of water inside a heat-resistant container and boil.
- Dip filters in the boiled solution and leave them fully submerged for about 30 minutes.
- Rinse thoroughly with clean water and run hot water through one group several times with the filters in place.
- Make one cup of coffee and discard in order to remove any unpleasant flavor.

## 3) Cleaning filter holders (portafilters)

Using the proper cleaning tool (brush) wash the filter holders under hot water, a neutral detergent may also be used. For extraordinary cleaning see the Portafilter Manual.

## 4) Cleaning the drain collector

Remove the drain tray grill at least twice a week and clean, pull out the water drain collector and clean it thoroughly. Inspect and clean also the drain box and remove any leftover grounds.

## 5) Cleaning the body

Wipe the stainless steel surfaces with a soft, non-abrasive cloth in the direction of the glazing marks, if any. Do not use any alcohol or solvents whatsoever on painted

or imprinted parts in order not to damage them.

## 6) Cleaning the hot water and steam nozzles

Steam nozzles must be cleaned immediately after use with a damp cloth and by producing a short burst of steam so as to prevent the formation of deposits inside the nozzles themselves, which may alter the flavor of other drinks to be heated. Hot water nozzles must be cleaned periodically with a damp cloth.

## 7) Cleaning the diffuser screen

- Due to filter holder discharge operations (subsequent to coffee brewing), a certain amount of coffee grounds may slowly build-up on and obstruct, even partially, the diffuser screen. To clean it, you must first remove it by unscrewing the diffuser screw.

- Put 2 or 3 teaspoons of cleaning detergent for coffee machines in about 1/2 a litre of water inside a heat-resistant container and boil.

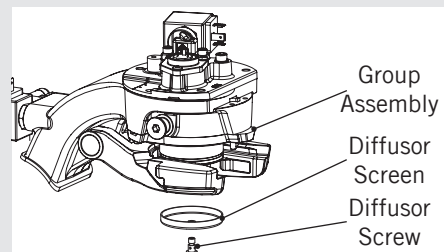

- Place the diffuser screen(s) and diffuser screw(s) in the solution and leave them fully submerged for about 30 minutes. Rinse thoroughly with clean water. Install and run hot water through each group several times with the screen installed.

## 8) Cleaning the portafilter group

After pressing the straight-in release lever, it is possible to use a non-abrasive soft cloth to clean the portafilter support. Do not use aggressive solvents on varnished parts or plastic parts to avoid damage. Clean the cover panels using a soft cloth. Only clean with a wet cloth or with a cloth soaked with warm water and neutral soap.

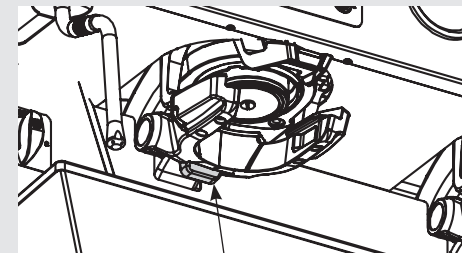

Straight-in Release Lever

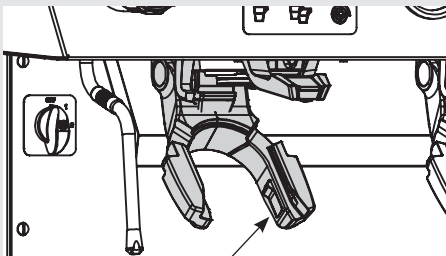

Portafilter Support

### 9) Water Filter/Softener

Please see the documentation accompanying the water filter/softener for proper operating and cleaning instructions.

• **Steam boiler draining:** to activate this function you need to access the programming menu (see page 104). Yearly, we recommend to fully drain the steam boiler by means of the specific drain cock located on the side of the boiler or under the boiler.

### 10) Depressurize the steam boiler

Press and hold the encoder knob to set the espresso machine to “OFF”, then push down the steam lever in order to depressurize the steam boiler.

### IMPORTANT

If the machine has not been used for more than 8 hours or, in any case, after long periods of being idle, in order to use the machine to its full potential it is necessary to perform some cleaning cycles before brewing beverages as follows:

- Groups: with the portafilters engaged in the groups brew water through each for at least two minutes
- Being careful to avoid burns, turn on each steam wand for at least one minute.
- Turn on the hot water valve for the time necessary to allow the following quantities of water to be brewed:  
At least 1 liter for a 1/2 group machine  
At least 2 liters for a 3 group machine

If the machine is not going to be used for long periods of time, it is advisable to follow these safety indications:

- Disconnect the machine from the water mains or interrupt the water connection via a mains tap.
- Disconnect the machine from the electrical mains.

## 7. De-commissioning and Demolition

### 1) De-commissioning and demolition

Start by setting the main switch to the “0” or OFF position.

#### Disconnecting from the power outlet

Disconnect the espresso machine from the electrical network by switching off the associated circuit breaker or circuit protection device. Remove the power supply cord from the power connection. Remove the Pump Motor Power Cord from the water pump motor.

#### Disconnecting from the water system

Shut off the water supply by closing the specific tap located upstream of the water filter/softener inlet. Disconnect the water pipe at the water filter/softener inlet.

Remove the hose connecting the espresso machine to the water pump. Remove the reinforced plastic tubing on the drain connection.

At this point, the machine may be removed from the bar, being very careful not to drop it or squash your fingers.

The machine is made out of various materials and therefore, if you do not intend to put it back in service, it must be taken to a special disposal company which will select the materials which can be recycled and discard the others.

Current regulations make it illegal to discard such machine by leaving it on public grounds or on any private property.

#### Recycling notice: Warning for the protection of the environment.

Used Electrical and electronic waste contains hazardous but also valuable and scarce materials which should be recovered and recycled properly. We kindly ask that you contribute to the protection of the environment and natural resources by delivering used equipment to the relevant recycling locations if such locations are available in your country.



## 8. Mandatory Maintenance and Check-up Operations

These operations are in addition to the Maintenance and Periodic Cleaning Operations as specified in Chapter 6.

The following maintenance and check-up operations could be carried out by a qualified technician.

The time required for the periodic maintenance is determined by the quantity of daily work and/or coffee consumption.

**N.B. These periodic maintenance operations are not covered by warranty.**

### EVERY THREE/FOUR MONTHS

- Replace group gaskets
- Replace diffuser screens
- Clean auto-fill probe
- Check vacuum breaker for proper operation
- Inspect water inlet valve
- Inspect drain system for leaks or clogs
- Check flow rate for each group
- Check brew temperature on Installation, otherwise warranty is voided)
- Check that brew pressure is at 9bar
- Check all switches for proper operation
- Check/note water hardness (Water quality must be within the range of parameters specified in the chapter
- Check filter basket condition
- Check shot volumes
- Test flowmeter's ohm value (ohm value is acceptable if greater than 1.8 K ohm, and less than 2.2 K ohm)

### EVERY SIX/EIGHT MONTHS (in addition to the above)

- Rebuild steam assemblies

### EVERY YEAR (in addition to the above)

- Replace portafilter baskets condition each cable on the terminal block.
- Inspect group valve plungers
- Inspect vacuum breaker
- Inspect contactor
- Inspect expansion valve
- Inspect electrical wiring
- Inspect boilers safety switches
- Replace over-pressure valve (safety valve)
- Accurate control of the tightness at 2,4Nm of

### EVERY 3 YEARS (in addition to the above)

- Check the condition of the inside of boilers and if necessary rinse out with a proper cleaning product allowed for food and beverage appliances.



## 9. Precision Scale

**WARNING**  
Handle with care maximum load  
1Kg do not lift.

**WARNING**  
The individual grid of the scale  
is a fragile component, handle  
and store with care.

**WARNING**  
The height of the bottom tray is  
fixed.

### 1) Use precautions

Remove the adhesive label with care; if needed, remove any adhesive residues from the surface using a neutral detergent.

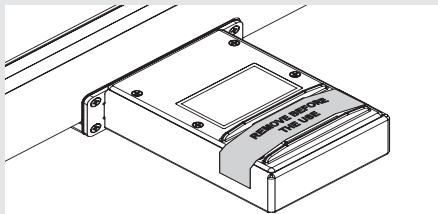

Don't spill water onto the scale box. If needed, gently remove it with an absorbent cloth. Should any water and/or dirt penetrate into the holes highlighted

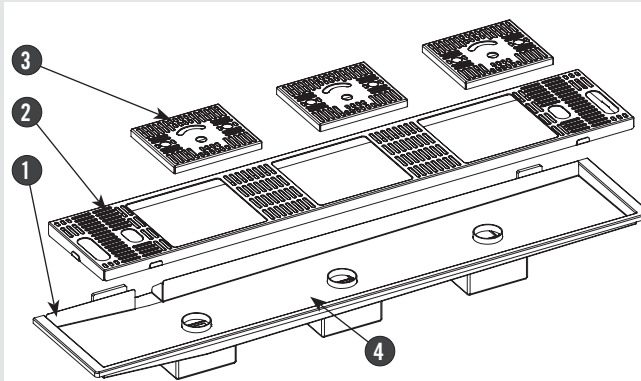

### Legend

- 1 Scale crosspiece
- 2 Drain grille
- 3 Scale individual grid
- 4 Removable drain tray

Fig. 6 - Precision Scale - 2, and 3 brewing groups

in the figure below, gently clean and dry them with an absorbent paper cloth. Dirt build-up or water stagnation may prevent the scale individual grid from properly settling into place.

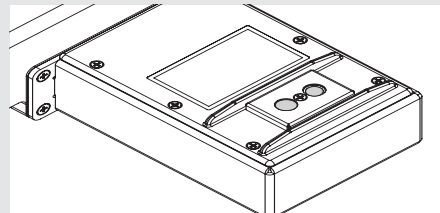

The weighing system in static conditions (\*) has a rated accuracy of  $\pm 0.5g$ . For correct operation, make sure that:

- Maintenance is performed properly, by an authorized person and in the manner prescribed in this manual;
- Please use the machine according to the instructions specified in this manual;
- Please make sure the machine is installed on a level and firm counter;
- Please make sure the power supply is stable and without electrical noises.

The weighing stage is a inherently delicate, in fact it is affected by:

- Vibration of the bench caused for example by other devices;
- Machine vibrations caused, for example, by the use of the adjacent group.

(\*) Static weighing means weighing an object whose weight is fixed during the entire weighing.

The machine is not a weighing device certified for legal weighing.

- The weighing system is a precision device that requires a lot of caution in terms of use, cleaning and maintenance.

- Should the main grid or tray be removed, ensure not to hit the load cells during the disassembly and reassembly operations.

- To proceed with the weighing of the filter holder either empty or filled with coffee powder, place it as shown below:

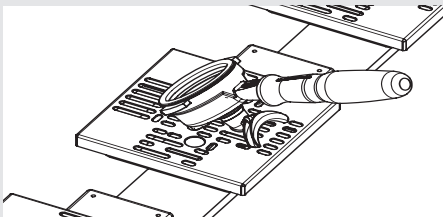

- Use only original La Marzocco filters and filter holders, identified by the following symbol:



- Use only filter holders with double spout;
- Do not place on the scale objects weighing more than 1kg;
- Never load more than 1 kg, to prevent any damage to the scales;
- Use the high precision scale with care, avoid shocks, falling objects and sudden load peaks;
- Any object to be weighed must be placed correctly on the scales grid.

## 2) Cleaning

- The cleaning of the “individual grids” must be performed with care, without overloading the cells;
- For proper weighing of the filter holder, make sure the grid is clean and dry;
- To avoid contact with dirt before placing the filter holder, clean and dry the grid;
- Please be careful during the cleaning procedures to avoid the water dripping on the scale and its electrical components;
- Don't wash the scale individual grids in a dishwasher; wash them manually instead, then immediately dry them.

If you wash the grid under a strong water flow, remove the magnetic support highlighted in the figure (just pull to detach the magnets). Make sure that the magnets are always dry and clean.

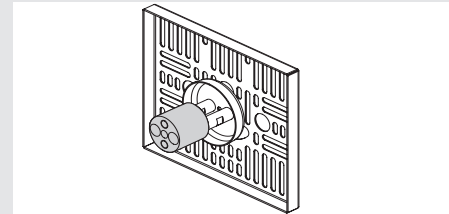

- To clean the drain tray you need to remove the individual grids (part 3, figure 6) first, then the drain grille (part 2, figure 6) and finally the tray (part 4, figure 6). Make sure not to hit the load cells during the disassembly and reassembly operations.

## 3) Removing the electronic box

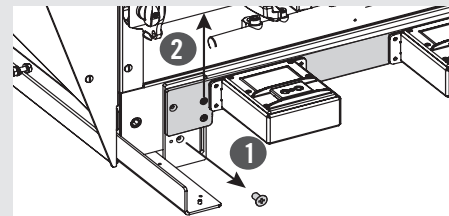

To remove the electronic box you need to remove the drain tray, unscrew and remove the lower screws ①, loosen the upper screws ② without removing them and move the scale crosspiece up. Now you can access the electronic box or remove it.

## 10. Straight-in

### 1) Installing the portafilters

1

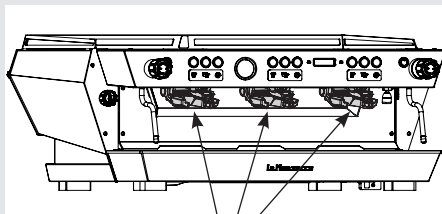

Straight-in

2

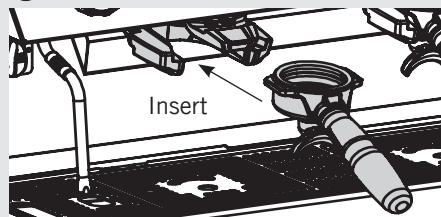

Insert

3

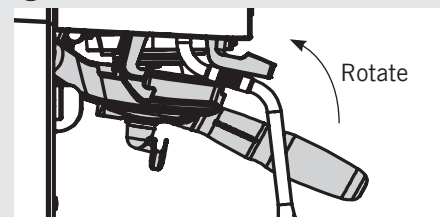

Rotate

### 2) Removal the portafilters

1

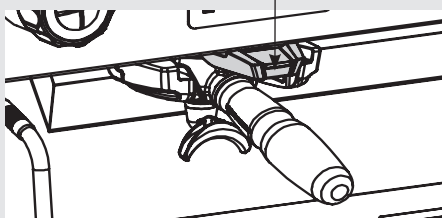

Press

2

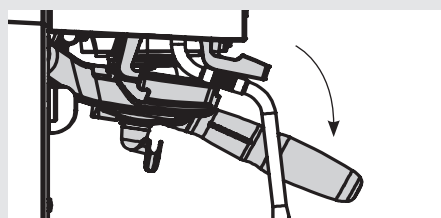

3

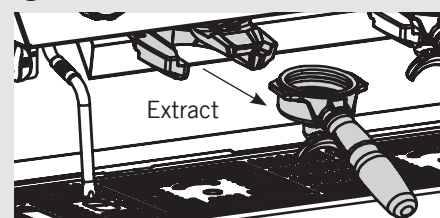

Extract

# 11. Software Programming Guide

# “Barista” Programming

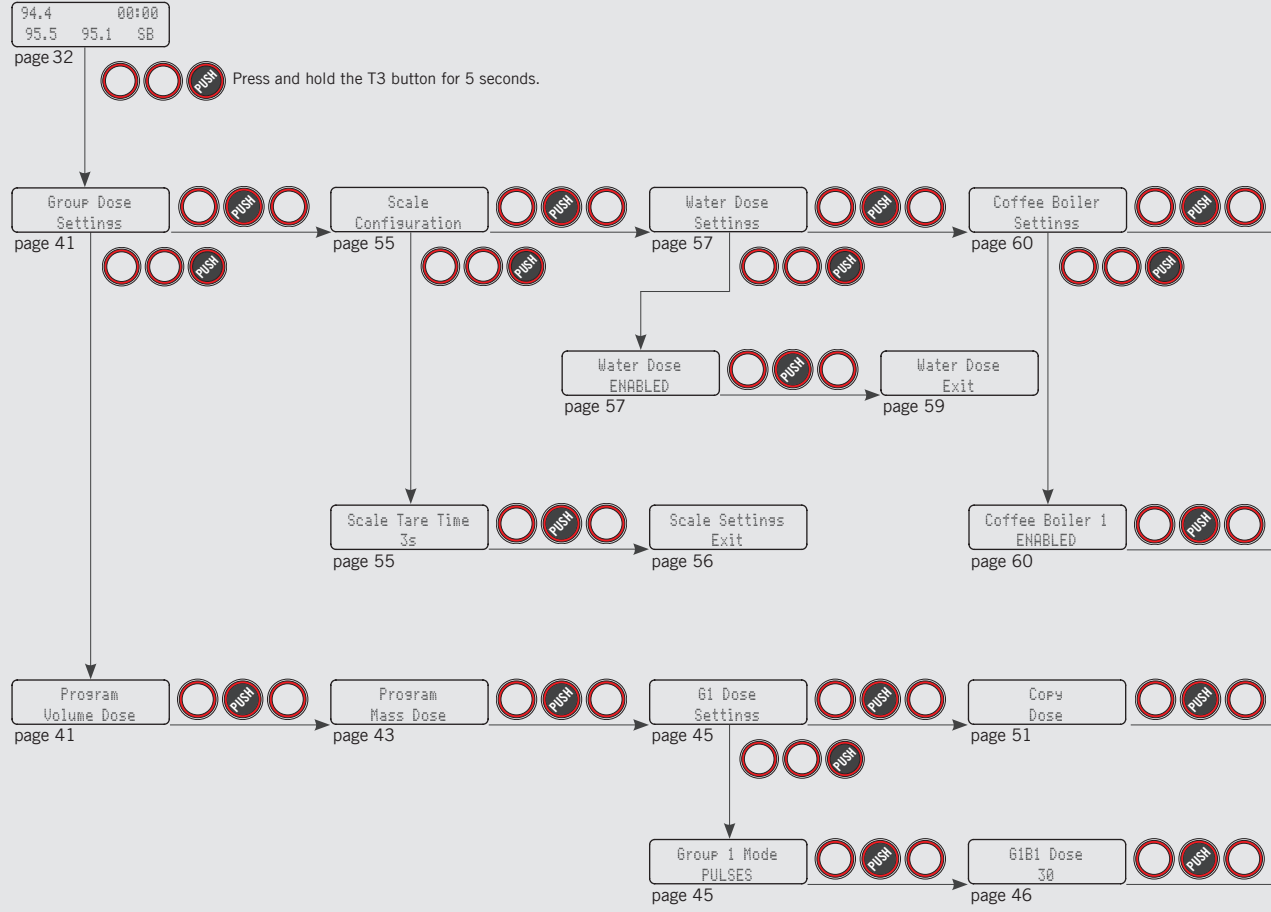

# “Barista” Programming

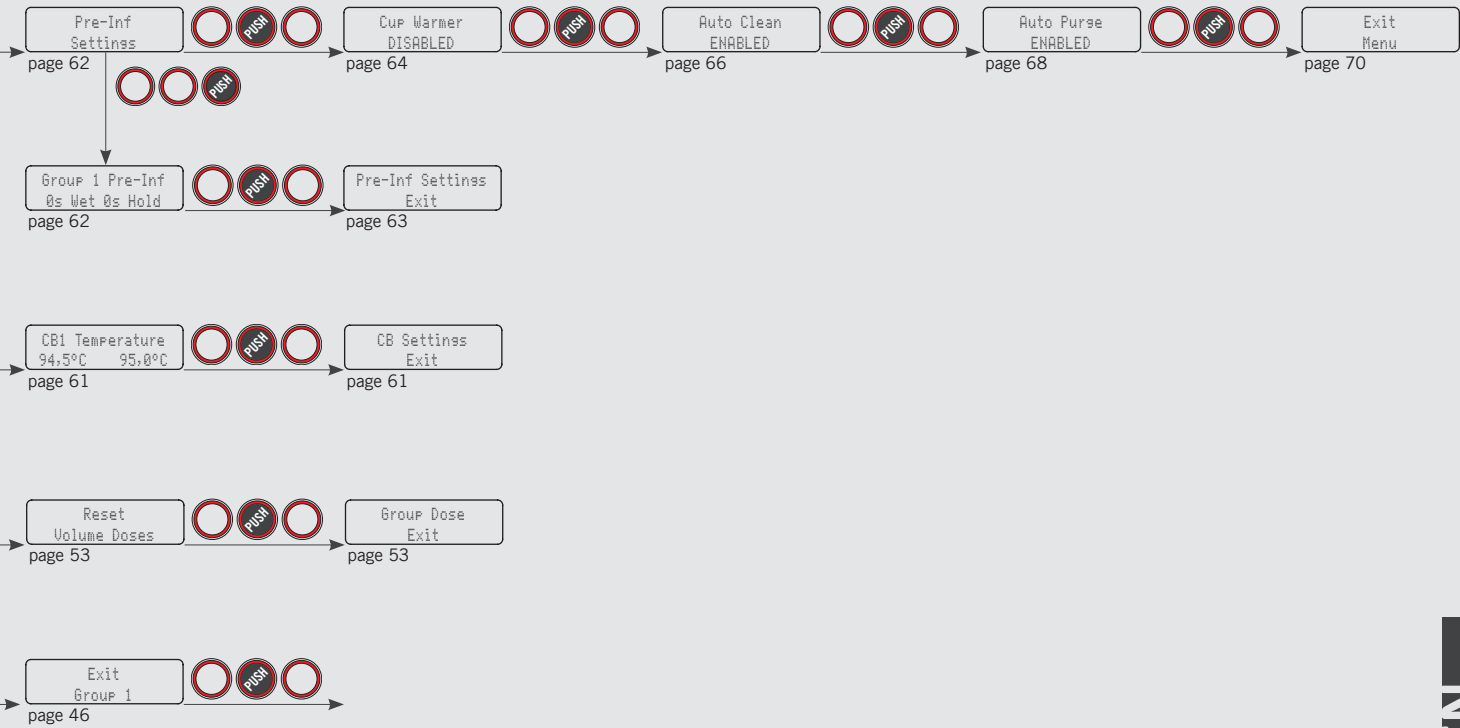

# “Technical” Programming

94.4 00:00  
95.5 95.1 SB

page 32



Press and hold the T3 button for 10 seconds.

Enter Password

page 38



Language  
ENGLISH

page 71



Temp Units  
CELSIUS

page 73



Name  
LaMarzocco

page 75



Group Dose  
Settings

page 77



Auto Purse  
ENABLED

page 125



Auto Clean  
ENABLED

page 123



Eco Mode  
Settings

page 121



Auto On/Off  
Settings

page 118



Coffee Dose  
Counter

page 127



Filter Alarm  
Settings

page 130



Reset  
Settings

page 133



Update  
Firmware

page 135



## “Technical” Programming

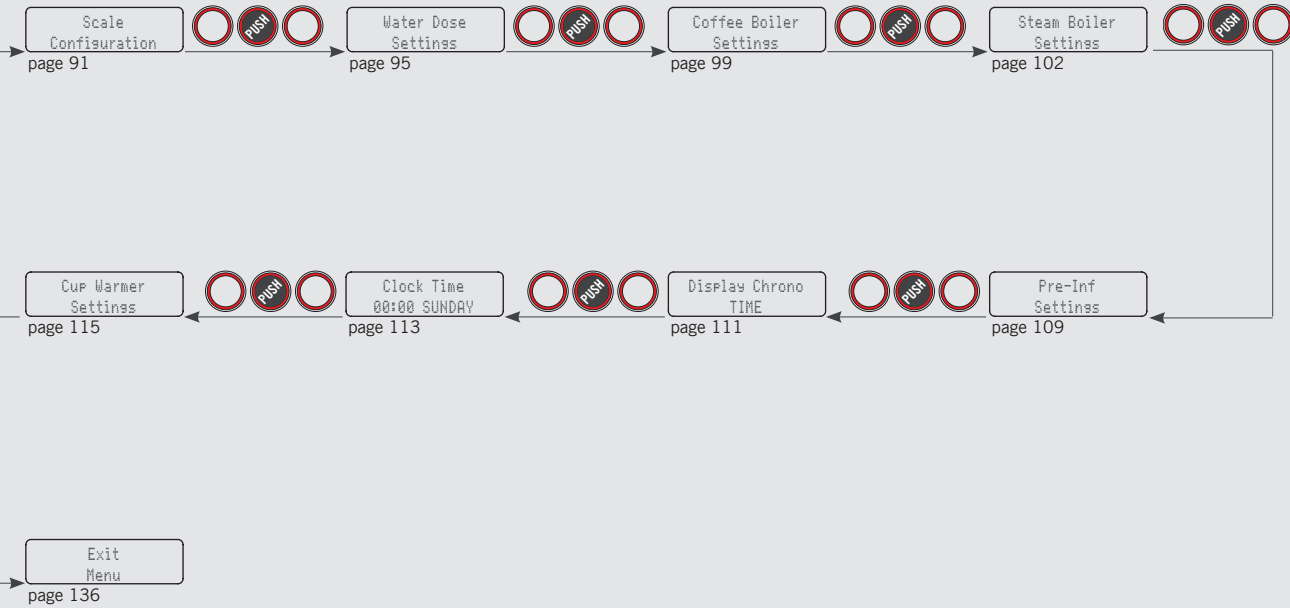

## Programming Introduction

### Description

- This espresso machine has a CPU and many configurable settings.
- Additionally, there are many feedback controls employed in this espresso machine to troubleshoot problems should they occur.
- The following is a brief introduction to the controls and display and how they interact with the operator.

## Digital Display

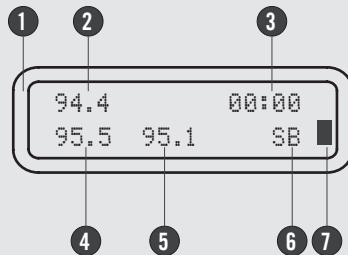

- |   |                                     |   |  |
|---|-------------------------------------|---|--|
| 1 | Digital display                     | 5 | 3rd group coffee boiler temperature  |
| 2 | 1st group coffee boiler temperature | 6 | Steam Boiler   |
| 3 | Daily timetable                     | 7 | Heating indicator (on during heating, off when the temperature has been reached) |
| 4 | 2nd group coffee boiler temperature |   |  |

The digital display is a backlit display capable of displaying 2 lines of 16 characters. The display enables the operator to interact with the espresso machine to visibly change parameter values. The display also provides valuable information to the operator.

There are several warnings that can be displayed to alert the operator of an unusual condition or a fault. Additionally, simple messages are displayed alerting the operator that an action has been started or that a process needs to begin.





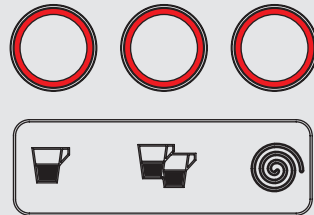



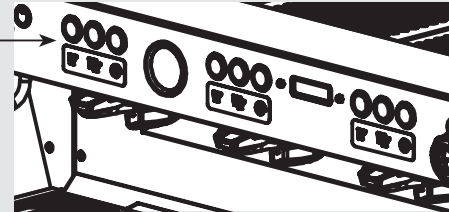

## Programming Keypad



Group 1



The keypad has two functions. The first is for control of the espresso. The second is for programming individual software parameters. The programming of the individual parameters is possible only using the buttons in the group 1 (group starting from the left).

Button	Description
 	<p>This button is used to control the brewing of the single espresso. It is also used in the programming of the individual parameters such as the “back” button in the menu.</p> <p>For simplicity's sake in this manual it will be represented by this symbol  with the name <b>T1</b>.</p>
 	<p>This button is used to control the brewing of the double espresso. It is also used in the programming of the individual parameters such as the “forward” button in the menu.</p> <p>For simplicity's sake in this manual it will be represented by this symbol  with the name <b>T2</b>.</p>
 	<p>This button is used for a continuous control of the brewing of the espresso. It is also used in the programming of the individual parameters such as the “enter” button in the menu.</p> <p>For simplicity's sake in this manual it will be represented by this symbol  with the name <b>T3</b>.</p>

## First Use Procedure

### Turning the Espresso Machine On

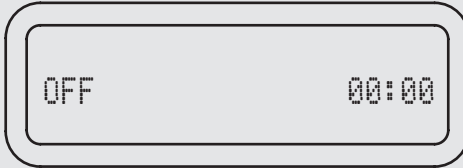

### Description

The following is the procedure to be followed for the first use of the espresso machine.

- Please follow the procedures carefully to avoid any damage to the espresso machine.

- Proceed checking for water connection to the espresso machine.
- Proceed making sure you have filled the boilers.

Display	Operating Procedure
	<b>1</b> Turn the Main Switch to the 1 position.
SB FILLED?	<b>2</b> To continue with the start up process, press the T3 button  after filling the steam boiler.
GROUPS BLEED?	<b>3</b> To continue with the start up process, press the T3 button  after the saturation of the coffee boiler.
<div data-bbox="178 965 331 1010"> <p>94.4      00:00 95.5    95.1    SB</p> </div>	<p><b>4</b> The rectangles next to CB and SB indicate the warming up of the water contained in the boilers. When the set temperature is reached, these rectangles turn off and all the lights of the buttons turn on. Now the machine is ready for use. During the normal operation of the machine, the flashing of the rectangles indicates the intermittent heating necessary for maintaining the temperature.</p> <p><b>NOTE:</b> Ensure all air is removed from the group prior to starting the espresso machine. This only needs to be completed once during the initial setup or when water is drained from the coffee boiler.</p>

WARNING

**HAZARDOUS VOLTAGE DISCONNECT FROM POWER SUPPLY BEFORE SERVICING**

## Start Up Procedures

### Turning the Espresso Machine On

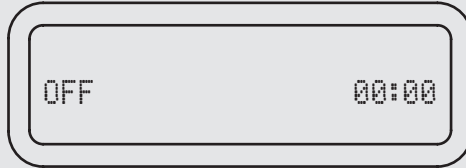

#### Description

The following is the procedure for turning on the power to the espresso machine.

- Please follow the procedures carefully to avoid any damage to the espresso machine.
- Proceed checking for water connection to the espresso machine.

- Proceed making sure you have filled the boilers.

Display	Operating Procedure
	<p><b>1</b> Turn the Main Switch to the 1 position.</p>
	<p><b>2</b> The message shown to the left will be displayed when the espresso machine is switched on.</p>
	<p><b>3</b> To complete the start up process, press any button. The screen shown to the left will be displayed. The rectangles next to CB and SB indicate the warming up of the water contained in the boilers. When the set temperature is reached, these rectangles turn off and all the lights of the buttons turn on. Now the machine is ready for use. During the normal operation of the machine, the flashing of the rectangles indicates the intermittent heating necessary for maintaining the temperature.</p> <p><b>NOTE:</b> Ensure all air is removed from the group prior to starting the espresso machine. This only needs to be completed once during the initial setup or when water is drained from the coffee boiler. Instructions for bleeding the groups of air can be found in the Installation Guide.</p>

**⚠ WARNING ⚠**

**HAZARDOUS VOLTAGE DISCONNECT FROM POWER SUPPLY BEFORE SERVICING**

## Shut Down Procedures

### Turning the Espresso Machine Off

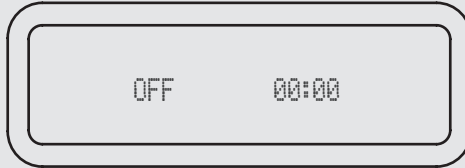



#### Description

The following is the procedure for turning off power to the espresso machine.

- Please follow the procedures carefully to avoid any damage to the espresso machine.

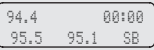
- This machine has two off settings. One setting turns off all of the components in the espresso machine and the other turns off power to the complete espresso machine.

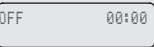
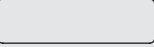
Display	Operating Procedure
	<p><b>1</b> The following is the procedure for safely turning off the espresso machine.</p> <p><b>2</b> Press and hold the buttons T2  and T3  at the same time. The display changes to the following:</p>
	<p><b>3</b> This is the OFF setting used in the normal operating conditions.</p> <p>During servicing or other conditions that warrant it, the main switch should be turned to the 0 position.</p> <p>The espresso machine is off and display should be blank. It is important to follow this procedure when turning off the machine. Failure to do so can damage the electronics.</p>
	<p><b>4</b></p>

**⚠ WARNING ⚠**

**HAZARDOUS VOLTAGE DISCONNECT FROM POWER SUPPLY BEFORE SERVICING**





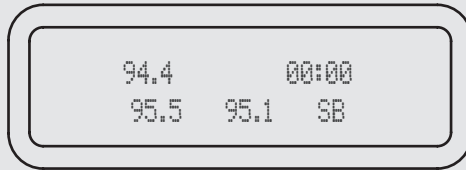

## Accessing Programming Mode

### Programming Mode



### Description

- To change the values of any parameter the operator must first enter into the programming mode.
- There are two levels within the programming mode that allow the programming of specific parameters.
- The two programming levels are as follows:
  - **Barista Programming** - The parameters contained within this level are ones the operator can change to affect the quality of the espresso. No password is required for access.

Display	Operating Procedure
<div data-bbox="213 668 370 711" style="border: 1px solid black; padding: 2px; margin-bottom: 10px;">                     94.4      00:00                      95.5    95.1    SB                 </div> <div data-bbox="213 786 370 830" style="border: 1px solid black; padding: 2px; margin-bottom: 10px; text-align: center;">                     Program Dose                 </div> <div data-bbox="213 839 370 883" style="border: 1px solid black; padding: 2px; margin-bottom: 10px; text-align: center;">                     Press Enter To Exit                 </div> <div data-bbox="213 948 370 992" style="border: 1px solid black; padding: 2px; text-align: center;">                     Exit Menu                 </div>	<p style="text-align: center;"><b>Barista” Programming Level</b></p> <ol style="list-style-type: none"> <li>1 While the espresso machine is on, press and hold the button T3  . After approximately 5 seconds the following display appears. This is the “Barista” programming level. To program the brewing amount for each button, to set the coffee boilers, the pre-infusion, and to enable/disable the resistance of the cup warmer if present.</li> <li>2 To exit the programming mode, scroll to the exit menu, using the buttons T1  or T2  . Press the T3  button to confirm the exit, or press at the same time the buttons T2 and T3.</li> <li>3 To exit the programming mode, scroll to the exit menu, using the buttons T1  or T2  . Press the T3  button to confirm the exit, or press at the same time the buttons T2 and T3.</li> </ol>



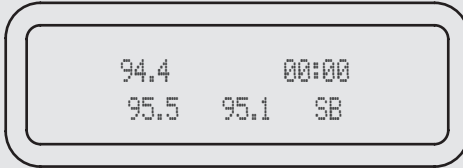

## Accessing Programming Mode

### Programming Mode



### Description

- **Technical Programming** - The parameters contained within this level are ones the operator can change to affect the performance of the espresso machine. These parameters are set in the factory and their adjustment requires the intervention of a service technician. La Marzocco recommends that no changes are made at this level. The Technician Password is required for access.

Display	Operating Procedure
<div data-bbox="178 665 331 711" style="border: 1px solid black; padding: 2px; margin-bottom: 10px;">           94.4      00:00            95.5   95.1   SB         </div> <div data-bbox="178 826 331 872" style="border: 1px solid black; padding: 2px;">           Enter Password            *****         </div>	<p style="text-align: center;"><b>Technical” Programming Level</b></p> <p><b>4</b> While the espresso machine is on, press and hold the button T3 . After approximately 10 seconds the following display appears.</p> <p>This is the “Technical” programming level. Enter the password and press the buttons T1  and T2  to move between the available parameters, press the T3 button  to confirm.</p> <p><b>5</b> <b>Note:</b> You must scroll to the exit menu to exit the programming mode, or press at the same time the buttons T2 and T3.</p>

## Cleaning Cycles



### Description

- This parameter allows the operator to carry out the washing of the coffee groups, in an automatic way, by running multiple cleaning cycles.
- This espresso machine has a group rinsing function (rinsing jets) integrated in the electronics.
- The rinsing procedure is provided to give the operator more flexibility and freedom with regard to this operation.

Display	Operating Procedure
	<p>When the espresso machine is on, to enable the washing procedure press and hold at the same time the buttons</p> <ol style="list-style-type: none"> <li>1 T1  and T3 .</li> </ol> <p>This activates the washing procedure of each group.</p> <ol style="list-style-type: none"> <li>2 When activated, the water pump comes into operation, and the electric valve of the specific group being washed will turn on and off the cycle. There are about 10 preset cycles with an interval of 4 seconds. To manually stop the rinsing, press any key.</li> </ol> <p><b>NOTE:</b> In order to properly rinse the groups, put a small amount of detergent in a blind portafilter basket and insert it in the group to be rinsed before activating the rinsing process.</p>

**WARNING**

**MOST DETERGENTS CAUSE FOAMING DURING THE CLEANING PROCESS. THIS FOAM COLLECTS AT THE DRAIN BOX AND CAN PROHIBIT WASTE WATER FROM DRAINING PROPERLY.**

**RINSING MULTIPLE GROUPS SIMULTANEOUSLY COULD CAUSE THE DRAIN BOX TO OVERFLOW.**

## Brewratio Programming (only on ABR espresso machine models)

### Brewratio

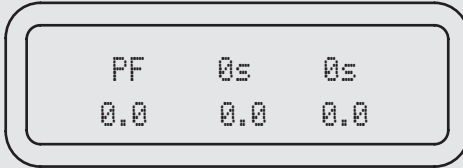



### Description

The procedure for weighing the filter holder either empty or filled with coffee powder is shown below.

- This parameter records the values for the brew according to the brew ratio technology.
- These values can be changed even manually by entering the software settings.

- To brew in brew ratio mode, set this mode by entering the software settings.
- Brew ratio: this mode is the ratio between the coffee powder and the weight of the drink

Display	Operating Procedure
<p>94.4 00:00 95.5 95.1 SB</p>	<p><b>1</b> When the espresso machine is on, press and hold the button T2 . After about 5 seconds the following screen is displayed.</p>
<p>PF 0s 0s 0.0 0.0 0.0</p>	<p><b>2</b> When the value is no longer flashing, place the empty filter holder on the appropriate seat of the grid as described in chapter 9. The value is automatically recorded. (*)</p>
<p>94.4 00:00 95.5 95.1 SB</p>	<p><b>3</b> Press and hold the button T1 . After about 5 seconds the following screen is displayed.</p> <p>When the value is no longer flashing, place the filter holder filled with coffee powder on the appropriate seat of the grid as described in chapter 9. The value is automatically recorded.</p>
<p>COF 0s 0s 0.0 0.0 0.0</p>	<p><b>4</b> This procedure can be repeated for all the brewing groups.</p> <p>(*) This procedure must be performed at the first installation, though it is possible to repeat it anytime (for example if you get a new portafilter set).</p>



## “Barista” Programming

### Program Dose

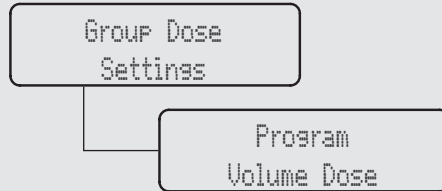

### Description

- This parameter allows the operator to program the amount of coffee (brewing amount) for each Selection Indicator.
- The brewing amount can be set in terms of time (sec.), pulses, mass or brewratio.
- Once programmed, the Selection Indicator remains lighted.
- It is possible to set the dose for both a short and a long shot on the same Selection Indicator.
- PULSE mode: control of doses in volume
- MASS mode: control of doses in mass
- BREW RATIO mode: ratio between the coffee powder and the weight of the drink

Display	Operating Procedure
	<b>1</b> When the espresso machine is turned on, press and hold the T3 button  to access the “Barista” programming. After about 5 seconds the following screen is displayed.
	<b>2</b> Press the button T1  or T2  to display the following menu.
	<b>3</b> Press the T3 button  to start the doses programming procedure.

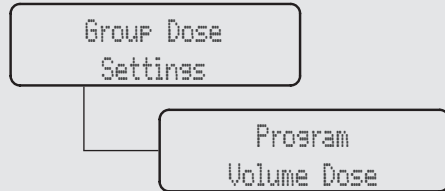

## “Barista” Programming

### Program Dose



### Description

- This parameter allows the operator to program the amount of coffee (brewing amount) for each Selection Indicator.
- The brewing amount can be set in terms of time (sec.), pulses, mass or brewratio.
- Once programmed, the Selection Indicator remains lighted.
- It is possible to set the dose for both a short and a long shot on the same Selection Indicator.
- PULSE mode: control of doses in volume
- MASS mode: control of doses in mass
- BREW RATIO mode: ratio between the coffee powder and the weight of the drink

Display	Operating Procedure
Press Enter To Exit  Press b To Stop 10 pulses  GIBI Saved 10 Pulses	<p>On each button you can set two doses, one for a short shot, one for a long shot.</p> <p>To set the brewing time of a short shot, press and release the button immediately, press again to stop and store the desired dose.</p> <p><b>4</b> To set the brewing time of a long shot, press and hold the button for about 2 seconds, press and release the button immediately to store the desired dose.</p> <p>The two doses of each key can be set independently from one another.</p> <p>If one of the two doses is not set or does not refer to the corresponding dose of the first group, it will work as continuous dose.</p>
Press Enter To Exit	<p><b>5</b> Press the T3 button  to return to the doses programming.</p>
Group Dose Exit	<p><b>6</b> Press T1  or T2  to continue with the programming of the other parameters.</p>

(only on ABR espresso machine models) **“Barista” Programming**

## Program Dose

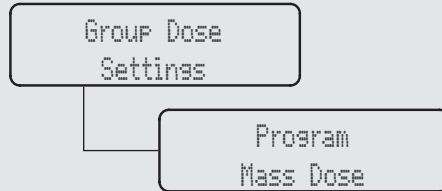

### Description

- This parameter allows the operator to program the amount of coffee (brewing amount) for each Selection Indicator.
- The brewing amount can be set in terms of time (sec.), pulses, mass or brewratio.
- Once programmed, the Selection Indicator remains lighted.
- It is possible to set the dose for both a short and a long shot on the same Selection Indicator.
- PULSE mode: control of doses in volume
- MASS mode: control of doses in mass
- BREW RATIO mode: ratio between the coffee powder and the weight of the drink

Display	Operating Procedure
	<b>1</b> When the espresso machine is turned on, press and hold the T3 button  to access the “Barista” programming. After about 5 seconds the following screen is displayed.
	<b>2</b> Press the button T1  or T2  to display the following menu.
	<b>3</b> Press the T3 button  to start the doses programming procedure.

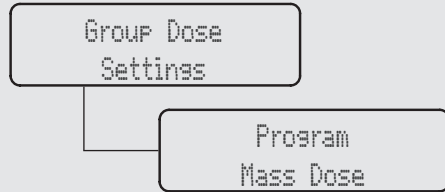

## “Barista” Programming (only on ABR espresso machine models)

### Program Dose



### Description

- This parameter allows the operator to program the amount of coffee (brewing amount) for each Selection Indicator.
- The brewing amount can be set in terms of time (sec.), pulses, mass or brewratio.
- Once programmed, the Selection Indicator remains lighted.
- It is possible to set the dose for both a short and a long shot on the same Selection Indicator.
- PULSE mode: control of doses in volume
- MASS mode: control of doses in mass
- BREW RATIO mode: ratio between the coffee powder and the weight of the drink

Display	Operating Procedure
Press Enter To Exit  Press b To Stop 20.0g  GIBI Saved 20.0g	<p>On each button you can set two doses, one for a short shot, one for a long shot.</p> <p>To set the brewing time of a short shot, press and release the button immediately, press again to stop and store the desired dose.</p> <p><b>4</b> To set the brewing time of a long shot, press and hold the button for about 2 seconds, press and release the button immediately to store the desired dose.</p> <p>The two doses of each key can be set independently from one another.</p> <p>If one of the two doses is not set or does not refer to the corresponding dose of the first group, it will work as continuous dose.</p>
Press Enter To Exit	<p><b>5</b> Press the T3 button  to return to the doses programming.</p>
Group Dose Exit	<p><b>6</b> Press T1  or T2  to continue with the programming of the other parameters.</p>

## “Barista” Programming

### Program Dose

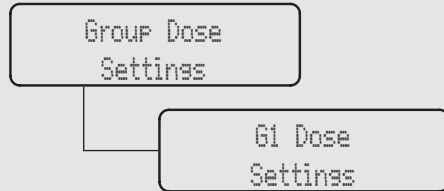

### Description

- This parameter allows the operator to program the amount of coffee (brewing amount) for each Selection Indicator.
- The brewing amount can be set in terms of time (sec.), pulses, mass or brewratio.
- Once programmed, the Selection Indicator remains lighted.
- It is possible to set the dose for both a short and a long shot on the same Selection Indicator.
- PULSE mode: control of doses in volume
- MASS mode: control of doses in mass
- BREW RATIO mode: ratio between the coffee powder and the weight of the drink

Display	Operating Procedure
	<b>1</b> When the espresso machine is turned on, press and hold the T3 button  to access the “Barista” programming. After about 5 seconds the following screen is displayed.
	<b>2</b> Press the button T1  or T2  to display the following menu.
	<b>3</b> Press the T3 button  to start the doses programming procedure.
	<b>4</b> Press the T3 button  to access the menu, then navigate using T1  and T2  to choose between PULSES, MASS and BREWRATIO, press the T3 button  to confirm the option.





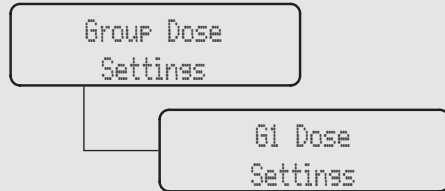













## “Barista” Programming

### Program Dose



### Description

- This parameter allows the operator to program the amount of coffee (brewing amount) for each button on the keyboard.
- The brewing amount can be set in terms of time (sec. ) or pulses. This number refers to the number of pulses that the flowmeter sends to the CPU.
- Once programmed, the button remains lighted.
- It is possible to set the dose for both a short and a long shot on the same key.
- The setting of the first group is automatically copied to the subsequent groups.
- It is possible to set each key individually, in this case the dose of the first group will no longer be used.
- It is possible to copy the doses of any key to the others.

Display	Operating Procedure
61B1 Dose 30	<b>5</b> Press the button T1  or T2  to view the dose. Pressing the button T3  , the dose value will blink. Use the button T1  or T2  to change the value, press the button T3  to confirm the desired value.
61B1 Long Dose 60	<b>6</b> Press the button T1  or T2  to view the dose. Pressing the button T3  , the dose value will blink. Use the button T1  or T2  to change the value, press the button T3  to confirm the desired value.
61B3 Mode CONTINUOUS	<b>7</b> Press the T3 button  to access the menu, then navigate using T1  and T2  to choose between , 3 SEC RINSE and CONTINUOUS, press the T3 button  to confirm the option.
Exit Group 1	<b>8</b> Press T1  or T2  until the display shows the exit menu, press the T3 button  to return to the “Barista” programming.





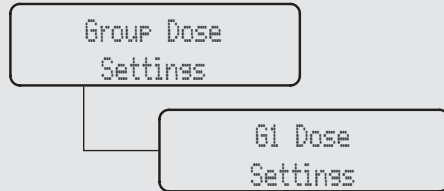

## “Barista” Programming

### Program Dose



### Description

- This parameter allows the operator to program the amount of coffee (brewing amount) for each button on the keyboard.
- The brewing amount can be set in terms of time (sec. ) or pulses. This number refers to the number of pulses that the flowmeter sends to the CPU.
- Once programmed, the button remains lighted.
- It is possible to set the dose for both a short and a long shot on the same key.
- The setting of the first group is automatically copied to the subsequent groups.
- It is possible to set each key individually, in this case the dose of the first group will no longer be used.
- It is possible to copy the doses of any key to the others.

Display	Operating Procedure
<div style="border: 1px solid black; padding: 5px; width: fit-content;">Group Dose Exit</div>	<p><b>9</b> Press T1  or T2  to continue with the programming of the other parameters.</p>
	<p><b>10</b> Press T1  or T2  to continue with the programming of the other parameters.</p>
<div style="border: 1px solid black; padding: 5px; width: fit-content;">94.4      00:00 95.5    95.1    SB</div>	<p><b>11</b> Press T2  and T3  at the same time to exit the programming mode and return to the normal use of the espresso machine.</p>

## “Barista” Programming (only on ABR espresso machine models)

### Program Dose Scales

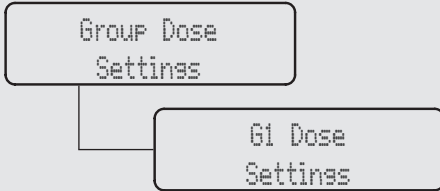

### Description

- This parameter allows the operator to view and manually change each dose for each key.
- For greater accuracy and consistency of the doses, it is recommended that you set each key.

Display	Operating Procedure
	<b>1</b> When the espresso machine is turned on, press and hold the T3 button  to access the “Barista” programming. After about 5 seconds the following screen is displayed.
	<b>2</b> Press the button T1  or T2  to display the following menu.
	<b>3</b> Press the T3 button  to start the doses programming procedure.
	<b>4</b> Press the T3 button  to access the menu, then navigate using T1  and T2  to choose between PULSES, MASS and BREWRATIO, press the T3 button  to confirm the option.























## Program Dose Scales

Group Dose  
Settings

G1 Dose  
Settings

### Description

- This parameter allows the operator to view and manually change each dose for each key.
- For greater accuracy and consistency of the doses, it is recommended that you set each key.

Display	Operating Procedure
<p>G1B1 Brew Ratio 1:2.00</p>	<p><b>5</b> Press the button T1  or T2  to view the dose of each key. Pressing the button T3 , the dose value will blink. Use the button T1  or T2  to change the value, press the button T3  to confirm the desired value.</p>
<p>G1 PF Mass 800.0g</p>	<p><b>6</b> Press the button T1  or T2  to view the portafilter mass of each group. Pressing the button T3 , the value will blink. Use the button T1  or T2  to change the value, press the button T3  to confirm the desired value.</p>
<p>G1 Coffee Mass 14.0g</p>	<p><b>7</b> Press the button T1  or T2  to view the coffee mass of each group. Pressing the button T3 , the value will blink. Use the button T1  or T2  to change the value, press the button T3  to confirm the desired value.</p>
<p>G1B3 Mode CONTINUOUS</p>	<p><b>8</b> Press the button T3  to enter the menu, then navigate using T1  and T2  to choose between CONTINUOUS or 3 SEC RINS.</p>





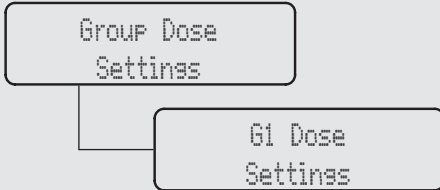



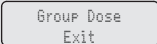

## “Barista” Programming (only on ABR espresso machine models)

### Program Dose Scales

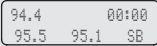

### Description

- This parameter allows the operator to view and manually change each dose for each key.
- For greater accuracy and consistency of the doses, it is recommended that you set each key.

Display	Operating Procedure
	<b>9</b> Press the button T3  to exit the submenu.
	<b>10</b> Press T1  or T2  until the display shows the exit menu, press the T3 button  to return to the “Barista” programming.
	<b>11</b> Press T1  or T2  to continue with the programming of the other parameters.
	<b>12</b> Press T2  and T3  at the same time to exit the programming mode and return to the normal use of the espresso machine.

## Program Dose

### Description

- This parameter allows the operator to copy the doses present of each key to the others.

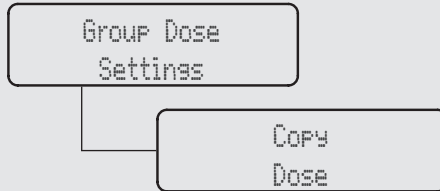

Display	Operating Procedure
	<b>1</b> When the espresso machine is turned on, press and hold the T3 button  to access the “Barista” programming. After about 5 seconds the following screen is displayed.
	<b>2</b> Press the button T1  or T2  to display the following menu.
	<b>3</b> Press the button T3  to start the dose copy procedure.
	<b>4</b> Press the key whose setting you want to copy. Now all the keys will flash.





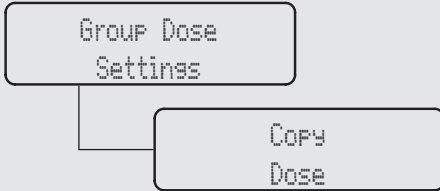

## “Barista” Programming

### Program Dose



### Description

- This parameter allows the operator to copy the doses present of each key to the others.

Display	Operating Procedure
<div data-bbox="178 668 333 714" style="border: 1px solid black; padding: 2px; text-align: center;">           Push to Paste Enter to Exit         </div>	<p><b>5</b> Press the key where you want to paste the previously copied setting. Successful programming is indicated by the fixed lighting of the key. It is possible to repeat this procedure on any key.</p>
<div data-bbox="178 800 333 846" style="border: 1px solid black; padding: 2px; text-align: center;">           Group Dose Exit         </div>	<p><b>6</b> Press T1  or T2  until the display shows the exit menu, press the T3 button  to return to the “Barista” programming.</p>
<div data-bbox="178 1060 333 1106" style="border: 1px solid black; padding: 2px;">           94.4      00:00 95.5   95.1   SB         </div>	<p><b>7</b> Press T1  or T2  to continue with the programming of the other parameters.</p> <p><b>8</b> Press T2  and T3  at the same time to exit the programming mode and return to the normal use of the espresso machine.</p>





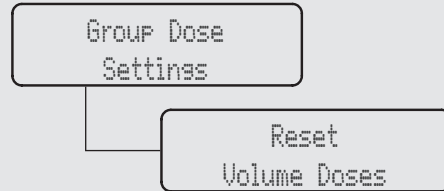

## “Barista” Programming

### Program Dose

### Description

- This parameter allows the operator to cancel all the doses set.



Display	Operating Procedure
<pre>           94.4    00:00           95.5    95.1  SB         </pre>	<b>1</b> When the espresso machine is turned on, press and hold the T3 button  to access the “Barista” programming. After about 5 seconds the following screen is displayed.
<pre>           Group Dose           Settings         </pre>	<b>2</b> Press the button T1  or T2  to display the following menu.
<pre>           Reset           Volume Doses           Resettina           Doses...         </pre>	<b>3</b> Press the button T3  to confirm the procedure. Now all settings are cleared.
<pre>           Group Dose           Exit         </pre>	<b>4</b> Press T1  or T2  until the display shows the exit menu, press the T3 button  to return to the “Barista” programming.

## “Barista” Programming





### Program Dose

### Description

- This parameter allows the operator to cancel all the doses set.

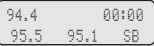
Group Dose  
Settings

Reset  
Volume Doses

Display	Operating Procedure
	<p><b>5</b> Press T1  or T2  to continue with the programming of the other parameters.</p> <p><b>6</b> Press T2  and T3  at the same time to exit the programming mode and return to the normal use of the espresso machine.</p>

## Scale Configuration

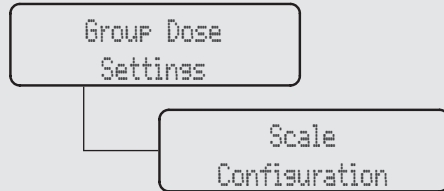

### Description

- This parameter allows the operator to view and manually change each dose for each Selection Indicator.
- For greater accuracy and consistency of the doses, it is recommended that you set each Selection Indicator.
- The dose can be set by pulses or by mass (weight).

Display	Operating Procedure
	<b>1</b> When the espresso machine is turned on, press and hold the T3 button  to access the “Barista” programming. After about 5 seconds the following screen is displayed.
	<b>2</b> Move between the parameters using the buttons T1  or T2  until the display shows:
	<b>3</b> Press the T3 button  to enter the menu.
	<b>4</b> Press the T3 button  to enter the menu, navigate the parameters using the buttons T1  and T2  to set the desired value. This parameter is common to all groups.





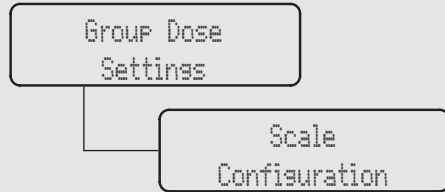



## “Barista” Programming (only on ABR espresso machine models)

### Scale Configuration

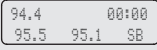

### Description

- This parameter allows the operator to view and manually change each dose for each Selection Indicator.
- For greater accuracy and consistency of the doses, it is recommended that you set each Selection Indicator.
- The dose can be set by pulses or by mass (weight).

Display	Operating Procedure
	<p><b>5</b> Press T1  or T2  until the display shows the exit menu, press the T3 button  to return to the “Barista” programming.</p>
	<p><b>6</b> Press T1  or T2  to continue with the programming of the other parameters.</p>
	<p><b>7</b> Press T2  and T3  at the same time to exit the programming mode and return to the normal use of the espresso machine.</p>



## “Barista” Programming

### Water Dose

### Description

- This parameter allows the operator to program the amount of water (brewing amount) for the hot water button.
- This feature can be enabled or disabled.

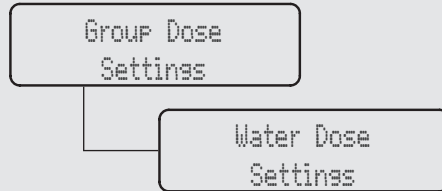

Display	Operating Procedure
	<b>1</b> When the espresso machine is turned on, press and hold the T3 button  to access the “Barista” programming. After about 5 seconds the following screen is displayed.
	<b>2</b> Move between the parameters using the buttons T1  or T2  until the display shows:
	<b>3</b> Press the T3 button  to enter the menu.
	<b>4</b> Press the T3 button  to enter the menu, move between the parameters using the buttons T1  and T2  to select <b>ENABLED</b> or <b>DISABLED</b> , press the T3 button  to confirm the option.





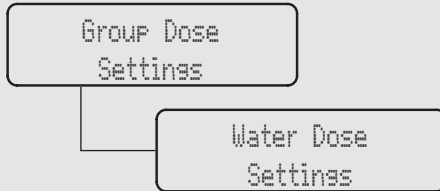

## “Barista” Programming

### Water Dose

### Description

- This parameter allows the operator to program the amount of water (brewing amount) for the hot water button.
- This feature can be enabled or disabled.



Display	Operating Procedure
<div style="border: 1px solid black; padding: 2px; margin-bottom: 2px;">Program Water Dose</div> <div style="border: 1px solid black; padding: 2px;">Program Long Water Dose</div>	<p><b>5</b> You can set two doses on the hot water button by selecting either Water Dose or Long Water Dose. Press T3  to start the dose setting procedure.</p>
<div style="border: 1px solid black; padding: 2px; margin-bottom: 2px;">Press Water Button To Stop</div> <div style="border: 1px solid black; padding: 2px; margin-bottom: 2px;">Press Water Button To Program</div> <div style="border: 1px solid black; padding: 2px;">Water Dose Saved 5.0 Seconds</div>	<p><b>6</b> To program the brewing time, press the hot water button to start and then press it again to stop when the desired dose is achieved. Now the saved brewing time is displayed.</p>
<div style="border: 1px solid black; padding: 2px;">Water Dose 5.0s</div>	<p><b>7</b> Press T1  or T2  to display the dose of the hot water button. Pressing the button T3 , the dose value will blink. Use the button T1  or T2  to change the value, press the button T3  to confirm the desired value.</p>









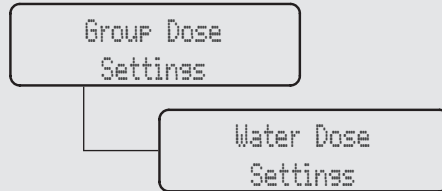



## “Barista” Programming

### Water Dose

### Description

- This parameter allows the operator to program the amount of water (brewing amount) for the hot water button.
- This feature can be enabled or disabled.



Display	Operating Procedure
<div style="border: 1px solid black; padding: 5px; width: fit-content;">           Long Water Dose 10.0s         </div>	<b>8</b> Press T1  or T2  to display the long dose of the hot water button. Pressing the button T3  , the dose value will blink. Use the button T1  or T2  to change the value, press the button T3  to confirm the desired value.
<div style="border: 1px solid black; padding: 5px; width: fit-content;">           Water Dose Exit         </div>	<b>9</b> Press T1  or T2  until the display shows the exit menu, press the T3 button  to return to the “Barista” programming.
	<b>10</b> Press T1  or T2  to continue with the programming of the other parameters.
<div style="border: 1px solid black; padding: 5px; width: fit-content;">           94.4      00:00 95.5    95.1    SB         </div>	<b>11</b> Press T2  and T3  at the same time to exit the programming mode and return to the normal use of the espresso machine.

## “Barista” Programming

### Coffee Boiler

### Description

- This parameter allows the operator to enable/disable the coffee boiler.
- This parameter allows the operator to program the coffee boiler temperature. Each group can have a different programming.

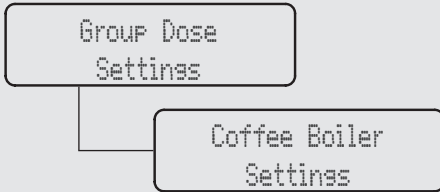

Display	Operating Procedure
	<p><b>1</b> When the espresso machine is turned on, press and hold the T3 button  to access the “Barista” programming. After about 5 seconds the following screen is displayed.</p>
	<p><b>2</b> Move between the parameters using the buttons T1  or T2  until the display shows:</p>
	<p><b>3</b> Press the T3 button  to enter the menu.</p>
	<p><b>4</b> Press the T3 button  to enter the menu, move between the parameters using the buttons T1  and T2  to select <b>ENABLED</b> or <b>DISABLED</b>, press the T3 button  to confirm the option. In the case of option enabled you can set the following parameters.</p>

## “Barista” Programming











### Coffee Boiler

#### Description

- This parameter allows the operator to enable/disable the coffee boiler.
- This parameter allows the operator to program the coffee boiler temperature. Each group can have a different programming.

Group Dose  
Settings

Coffee Boiler  
Settings

Display	Operating Procedure
<p>CB1 Temperature 93.1°C 93.3°C</p>	<p><b>5</b> Press the T3 button  to enter the menu, move with the buttons T1  and T2  to set the desired temperature, press the T3 button  to confirm the value. In the case of espresso machine a multiple boilers you can set the temperature also on the coffee boiler. The temperature indicated on the left is the actual temperature of the group while the temperature on the right is the set temperature.</p>
<p>CB Settings Exit</p>	<p><b>6</b> Press T1  or T2  until the display shows the exit menu, press the T3 button  to return to the “Barista” programming.</p>
	<p><b>7</b> Press T1  or T2  to continue with the programming of the other parameters.</p>
<p>94.4 00:00 95.5 95.1 SB</p>	<p><b>8</b> Press T2  and T3  at the same time to exit the programming mode and return to the normal use of the espresso machine.</p>

## “Barista” Programming

### Pre-Infusion or Pre-Brewing

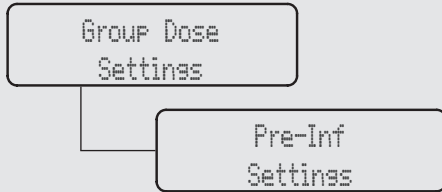

### Description

- This parameter allows the operator to program the time of pre-brewing of water with the coffee. Each group can have a different programming.
- Pre-brewing has only two values to be adjusted for each group. The time (in seconds) for which the brewing valve is open during the pre-brewing cycle and the time (in seconds) for which the brewing valve is closed during the pre-brewing cycle; during this time the pump is active. Once the pre-brewing cycle is over, the normal brewing cycle will continue until the end.
- For an espresso machine composed of three groups, they are identified as Group 1, Group 2 and Group 3.

Display	Operating Procedure
	<b>1</b> When the espresso machine is turned on, press and hold the T3 button  to access the “Barista” programming. After about 5 seconds the following screen is displayed.
	<b>2</b> Move between the parameters using the buttons T1  or T2  until the display shows:
	<b>3</b> Press the T3 button  to enter the menu.
	<b>4</b> Press T1  or T2  to select the group whose parameters you want to set. By pressing the T3 button  the first value will blink. Use the buttons T1  and T2  to reach the value that you want to set, press T3  to confirm. Repeat this operation to set the second value.

## “Barista” Programming

### Pre-Infusion or Pre-Brewing

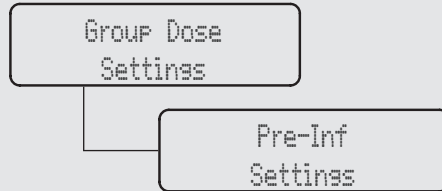







### Description

- This parameter allows the operator to program the time of pre-brewing of water with the coffee. Each group can have a different programming.
- Pre-brewing has only two values to be adjusted for each group. The time (in seconds) for which the brewing valve is open during the pre-brewing cycle and the time (in seconds) for which the brewing valve is closed during the

pre-brewing cycle; during this time the pump is active. Once the pre-brewing cycle is over, the normal brewing cycle will continue until the end.

- For an espresso machine composed of three groups, they are identified as Group 1, Group 2 and Group 3.

Display	Operating Procedure
<div data-bbox="213 668 368 711" style="border: 1px solid black; padding: 2px; width: fit-content;">           Pre-Inf Settings Exit         </div>	<p><b>5</b> Press T1  or T2  until the display shows the exit menu, press the T3 button  to return to the “Barista” programming.</p> <p><b>6</b> Press T1  or T2  to continue with the programming of the other parameters.</p>
<div data-bbox="213 931 368 971" style="border: 1px solid black; padding: 2px; width: fit-content;">           94.4      00:00 95.5    95.1   SB         </div>	<p><b>7</b> Press T2  and T3  at the same time to exit the programming mode and return to the normal use of the espresso machine.</p>

## “Barista” Programming

### Cup Warmer

### Description

- This parameter allows the operator to enable or disable the cups heating function.
- This function is displayed only on the models of espresso machine equipped with this accessory.

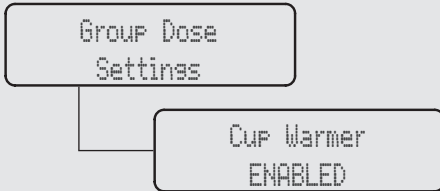

Display	Operating Procedure
	<p><b>1</b> When the espresso machine is turned on, press and hold the T3 button  to access the “Barista” programming. After about 5 seconds the following screen is displayed.</p>
	<p><b>2</b> Move between the parameters using the buttons T1  or T2  until the display shows:</p>
	<p><b>3</b> Press the T3 button  to enter the menu, move between the parameters using the buttons T1  and T2  to select <b>ENABLED</b> or <b>DISABLED</b>, press the T3 button  to confirm the option.</p>
	<p><b>4</b> Press T1  or T2  to continue with the programming of the other parameters.</p>



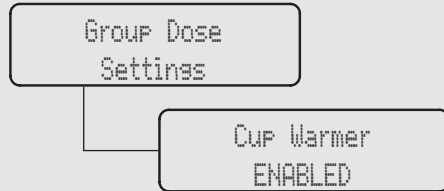

## “Barista” Programming

### Cup Warmer



### Description

- This parameter allows the operator to enable or disable the cups heating function.
- This function is displayed only on the models of espresso machine equipped with this accessory.

Display	Operating Procedure
<p>94.4      00:00 95.5    95.1   SB</p>	<p><b>5</b> Press T2  and T3  at the same time to exit the programming mode and return to the normal use of the espresso machine.</p>

## “Barista” Programming

### Auto Clean

### Description

- This parameter allows the operator to enable or disable the auto clean function.
- If the autoclean function is enabled in the menu, steam will be delivered by the group with a delay of 2 seconds form portafilter removal.

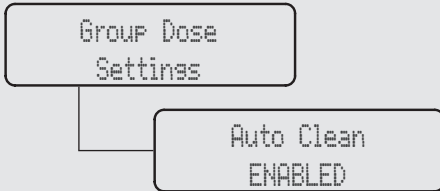

Display	Operating Procedure
	<p><b>1</b> When the espresso machine is turned on, press and hold the T3 button  to access the “Barista” programming. After about 5 seconds the following screen is displayed.</p>
	<p><b>2</b> Move between the parameters using the buttons T1  or T2  until the display shows:</p>
	<p><b>3</b> Press the T3 button  to enter the menu, move between the parameters using the buttons T1  and T2  to select <b>ENABLED</b> or <b>DISABLED</b> , press the T3 button  to confirm the option.</p>

**⚠ WARNING ⚠**

**THE STEAM HAS ELEVATED TEMPERATURES.  
WATER TEMPERATURE OVER 52°C CAN CAUSE SEVERE BURNS INSTANTLY OR DEATH FROM SCALDING.**

## “Barista” Programming





### Auto Clean

Group Dose  
Settings

Auto Clean  
ENABLED

### Description

- This parameter allows the operator to enable or disable the auto clean function.
- If the autoclean function is enabled in the menu, steam will be delivered by the group with a delay of 2 seconds form portafilter removal.

Display	Operating Procedure
 <p>94.4 00:00 95.5 95.1 SB</p>	<p><b>4</b> Press T1  or T2  to continue with the programming of the other parameters.</p> <p><b>5</b> Press T2  and T3  at the same time to exit the programming mode and return to the normal use of the espresso machine.</p>



### WARNING



THE STEAM HAS ELEVATED TEMPERATURES.  
WATER TEMPERATURE OVER 52°C CAN CAUSE SEVERE BURNS INSTANTLY OR DEATH FROM SCALDING.

## “Barista” Programming

### Auto Purge

### Description

- This parameter allows the operator to enable or disable the auto clean function.
- If the autopurge function is enabled in the menu, hot water will be delivered by the group with a delay of 2 seconds form portafilter removal.

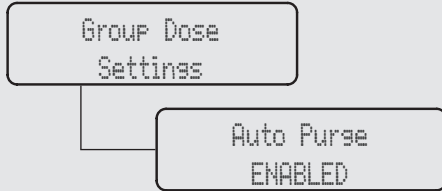

Display	Operating Procedure
	<p><b>1</b> When the espresso machine is turned on, press and hold the T3 button  to access the “Barista” programming. After about 5 seconds the following screen is displayed.</p>
	<p><b>2</b> Move between the parameters using the buttons T1  or T2  until the display shows:</p>
	<p><b>3</b> Press the T3 button  to enter the menu, move between the parameters using the buttons T1  and T2  to select <b>ENABLED</b> or <b>DISABLED</b>, press the T3 button  to confirm the option.</p>

**⚠ WARNING ⚠**  
 THE COFFEE BOILER CONTAINS WATER AT ELEVATED TEMPERATURES.  
 WATER TEMPERATURE OVER 52°C CAN CAUSE SEVERE BURNS INSTANTLY OR DEATH FROM SCALDING.

## “Barista” Programming





### Auto Purge

Group Dose  
Settings

Auto Purge  
ENABLED

### Description

- This parameter allows the operator to enable or disable the auto clean function.
- If the autopurge function is enabled in the menu, hot water will be delivered by the group with a delay of 2 seconds form portafilter removal.

Display	Operating Procedure
 <p>94.4      00:00 95.5    95.1    SB</p>	<p><b>4</b> Press T1  or T2  to continue with the programming of the other parameters.</p> <p><b>5</b> Press T2  and T3  at the same time to exit the programming mode and return to the normal use of the espresso machine.</p>



### WARNING



THE COFFEE BOILER CONTAINS WATER AT ELEVATED TEMPERATURES.  
WATER TEMPERATURE OVER 52°C CAN CAUSE SEVERE BURNS INSTANTLY OR DEATH FROM SCALDING.



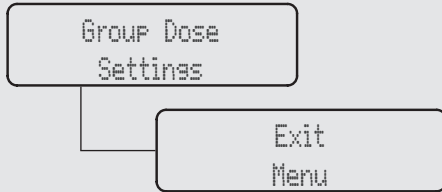

## “Barista” Programming

### Exit Menu

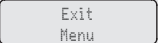

### Description

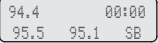
- This parameter allows the operator to exit the “Barista” programming and return to the normal use of the espresso machine.

Display	Operating Procedure
	<ol style="list-style-type: none"> <li>1 Press the T3 button  to exit the “Barista” programming and return to the normal use of the espresso machine.</li> </ol>
	<ol style="list-style-type: none"> <li>2 Alternatively, you can exit the “Barista” programming and return to the normal use of the espresso machine by pressing T2  and T3  at the same time.</li> </ol>

### Language

### Description

- This parameter allows the technician to change the language of the display.

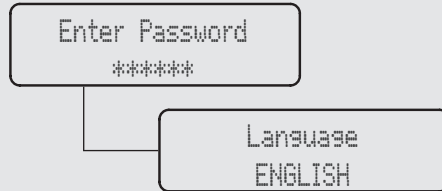

Display	Operating Procedure
	<p><b>1</b> When the espresso machine is turned on, press and hold the T3 button . After about 10 seconds the following screen is displayed.</p>
	<p><b>2</b> Enter the technician password using the buttons T1 , T2  and T3 . After the acceptance, the following screen is displayed.</p>
	<p><b>3</b> Press the T3 button  to enter the menu, move between the parameters using the buttons T1  and T2  to select a language, press the T3 button  to confirm the option.</p>
	<p><b>4</b> Press T1  or T2  to continue with the programming of the other parameters.</p>





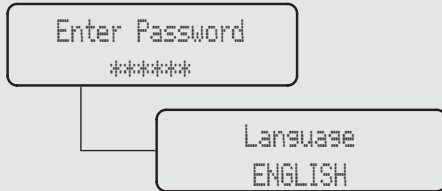

## “Technical” Programming

### Language

### Description

- This parameter allows the technician to change the language of the display.

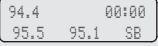

Display	Operating Procedure
	<p><b>5</b> To exit the menu move between the parameters using the buttons T1  and T2  until the exit menu is displayed. Press the T3 button  to exit the menu and return to the normal use of the espresso machine.</p>
	<p><b>6</b> Alternatively, you can exit the “Technical” programming and return to the normal use of the espresso machine by pressing T2  and T3  at the same time.</p>









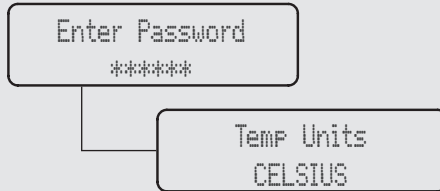



### Temperature Measurement Units

#### Description

- This parameter allows the technician to change the temperature display from degrees Celsius to degrees Fahrenheit and vice versa.



Display	Operating Procedure
Enter Password *****	<b>1</b> After accessing the “Technical” programming menu and entering the password, use the buttons T1  and T2  until the following screen is displayed.
Temp Units CELSIUS	<b>2</b> Press the T3 button  to enter the menu, move between the parameters using the buttons T1  and T2  to select an option, press the T3 button  to confirm the option.
	<b>3</b> Press T1  or T2  to continue with the programming of the other parameters.
Exit Menu	<b>4</b> To exit the menu move between the parameters using the buttons T1  and T2  until the exit menu is displayed. Press the T3 button  to exit the menu and return to the normal use of the espresso machine.

## “Technical” Programming



### Temperature Measurement Units

Enter Password  
\*\*\*\*\*

Temp Units  
CELSIUS

#### Description

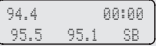
- This parameter allows the technician to change the temperature display from degrees Celsius to degrees Fahrenheit and vice versa.

Display	Operating Procedure
 <p>94.4 00:00 95.5 95.1 SB</p>	<p><b>5</b> Alternatively, you can exit the “Technical” programming and return to the normal use of the espresso machine by pressing T2  and T3  at the same time.</p>









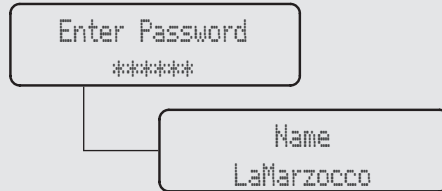

## “Technical” Programming

### Name

### Description



- This parameter allows the technician to program a 16 character user name.
- The user name is displayed continuously on the display on the second line.



Display	Operating Procedure
<div style="border: 1px solid black; padding: 5px; width: fit-content;">                     Enter Password *****                 </div>	<p><b>1</b> After accessing the “Technical” programming menu and entering the password, use the buttons T1  and T2  until the following screen is displayed.</p>
<div style="border: 1px solid black; padding: 5px; width: fit-content;">                     Name LaMarzocco                 </div>	<p><b>2</b> Press the T3 button  to enter the menu, use the buttons T1  and T2  to set the desired value, press the T3 button  to confirm the value and proceed with writing.</p>
	<p><b>3</b> Press T1  or T2  to continue with the programming of the other parameters.</p>
<div style="border: 1px solid black; padding: 5px; width: fit-content;">                     Exit Menu                 </div>	<p><b>4</b> To exit the menu move between the parameters using the buttons T1  and T2  until the exit menu is displayed. Press the T3 button  to exit the menu and return to the normal use of the espresso machine.</p>

## “Technical” Programming

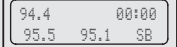
Name	Description
	<ul style="list-style-type: none"> <li>• This parameter allows the technician to program a 16 character user name.</li> <li>• The user name is displayed continuously on the display on the second line.</li> </ul>

Display	Operating Procedure
	<p><b>5</b> Alternatively, you can exit the “Technical” programming and return to the normal use of the espresso machine by pressing T2  and T3  at the same time.</p>



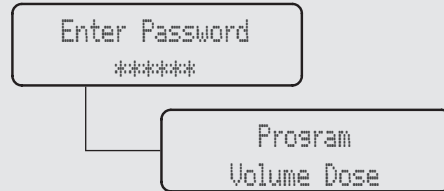

## “Technical” Programming

### Program Dose



### Description

- This parameter allows the operator to program the amount of coffee (brewing amount) for each Selection Indicator.
- The brewing amount can be set in terms of time (sec.), pulses, mass or brewratio.
- Once programmed, the Selection Indicator remains lighted.
- It is possible to set the dose for both a short and a long shot on the same Selection Indicator.
- PULSE mode: control of doses in volume
- MASS mode: control of doses in mass
- BREW RATIO mode: ratio between the coffee powder and the weight of the drink

Display	Operating Procedure
Enter Password *****	<b>1</b> After accessing the “Technical” programming menu and entering the password, use the buttons T1  and T2  until the following screen is displayed.
Group Dose Settings	<b>2</b> Press the button T1  or T2  to display the following menu.
Program Volume Dose	<b>3</b> Press the T3 button  to start the doses programming procedure.

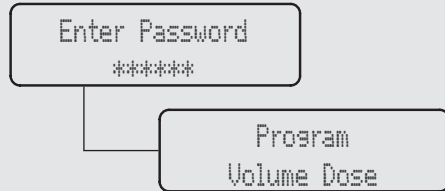

## “Technical” Programming

### Program Dose



### Description

- This parameter allows the operator to program the amount of coffee (brewing amount) for each Selection Indicator.
- The brewing amount can be set in terms of time (sec.), pulses, mass or brewratio.
- Once programmed, the Selection Indicator remains lighted.
- It is possible to set the dose for both a short and a long shot on the same Selection Indicator.
- PULSE mode: control of doses in volume
- MASS mode: control of doses in mass
- BREW RATIO mode: ratio between the coffee powder and the weight of the drink



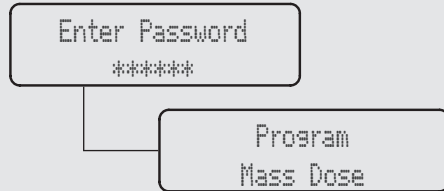

Display	Operating Procedure
Press Enter To Exit  Press b To Stop 10 pulses  GIBI Saved 10 Pulses	<p>On each button you can set two doses, one for a short shot, one for a long shot.</p> <p>To set the brewing time of a short shot, press and release the button immediately, press again to stop and store the desired dose.</p> <p><b>4</b> To set the brewing time of a long shot, press and hold the button for about 2 seconds, press and release the button immediately to store the desired dose.</p> <p>The two doses of each key can be set independently from one another.</p> <p>If one of the two doses is not set or does not refer to the corresponding dose of the first group, it will work as continuous dose.</p>
Press Enter To Exit	<p><b>5</b> Press the T3 button  to return to the doses programming.</p>
Group Dose Exit	<p><b>6</b> Press T1  or T2  to continue with the programming of the other parameters.</p>

## Program Dose



### Description

- This parameter allows the operator to program the amount of coffee (brewing amount) for each Selection Indicator.
- The brewing amount can be set in terms of time (sec.), pulses, mass or brewratio.
- Once programmed, the Selection Indicator remains lighted.
- It is possible to set the dose for both a short and a long shot on the same Selection Indicator.
- PULSE mode: control of doses in volume
- MASS mode: control of doses in mass
- BREW RATIO mode: ratio between the coffee powder and the weight of the drink

Display	Operating Procedure
Enter Password *****	<b>1</b> After accessing the “Technical” programming menu and entering the password, use the buttons T1  and T2  until the following screen is displayed.
Group Dose Settings	<b>2</b> Press the button T1  or T2  to display the following menu.
Program Mass Dose	<b>3</b> Press the T3 button  to start the doses programming procedure.

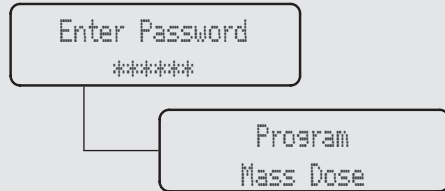

## “Technical” Programming (only on ABR espresso machine models)

### Program Dose



### Description

- This parameter allows the operator to program the amount of coffee (brewing amount) for each Selection Indicator.
- The brewing amount can be set in terms of time (sec.), pulses, mass or brewratio.
- Once programmed, the Selection Indicator remains lighted.
- It is possible to set the dose for both a short and a long shot on the same Selection Indicator.
- PULSE mode: control of doses in volume
- MASS mode: control of doses in mass
- BREW RATIO mode: ratio between the coffee powder and the weight of the drink

Display	Operating Procedure
Press Enter To Exit  Press b To Stop 20.0g  GIBI Saved 20.0g	<p>On each button you can set two doses, one for a short shot, one for a long shot.</p> <p>To set the brewing time of a short shot, press and release the button immediately, press again to stop and store the desired dose.</p> <p><b>4</b> To set the brewing time of a long shot, press and hold the button for about 2 seconds, press and release the button immediately to store the desired dose.</p> <p>The two doses of each key can be set independently from one another.</p> <p>If one of the two doses is not set or does not refer to the corresponding dose of the first group, it will work as continuous dose.</p>
Press Enter To Exit	<p><b>5</b> Press the T3 button  to return to the doses programming.</p>
Group Dose Exit	<p><b>6</b> Press T1  or T2  to continue with the programming of the other parameters.</p>







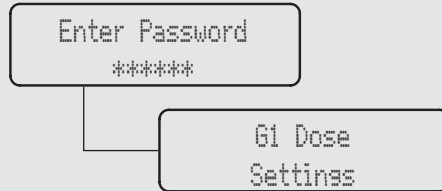



## “Technical” Programming

### Program Dose



### Description

- This parameter allows the operator to program the amount of coffee (brewing amount) for each Selection Indicator.
- The brewing amount can be set in terms of time (sec.), pulses, mass or brewratio.
- Once programmed, the Selection Indicator remains lighted.
- It is possible to set the dose for both a short and a long shot on the same Selection Indicator.
- PULSE mode: control of doses in volume
- MASS mode: control of doses in mass
- BREW RATIO mode: ratio between the coffee powder and the weight of the drink

Display	Operating Procedure
Enter Password *****	1 After accessing the “Technical” programming menu and entering the password, use the buttons T1  and T2  until the following screen is displayed.
Group Dose Settings	2 Press the button T1  or T2  to display the following menu.
G1 Dose Settings	3 Press the T3 button  to start the doses programming procedure.
Group 1 Mode PULSES	4 Press the T3 button  to access the menu, then navigate using T1  and T2  to choose between PULSES, MASS and BREWRATIO, press the T3 button  to confirm the option.





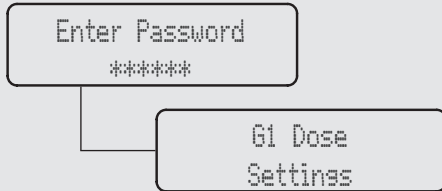













## “Technical” Programming

### Program Dose



### Description

- This parameter allows the operator to program the amount of coffee (brewing amount) for each button on the keyboard.
- The brewing amount can be set in terms of time (sec. ) or pulses. This number refers to the number of pulses that the flowmeter sends to the CPU.
- Once programmed, the button remains lighted.
- It is possible to set the dose for both a short and a long shot on the same key.
- The setting of the first group is automatically copied to the subsequent groups.
- It is possible to set each key individually, in this case the dose of the first group will no longer be used.
- It is possible to copy the doses of any key to the others.

Display	Operating Procedure
61B1 Dose 30	<b>5</b> Press the button T1  or T2  to view the dose. Pressing the button T3  , the dose value will blink. Use the button T1  or T2  to change the value, press the button T3  to confirm the desired value.
61B1 Long Dose 60	<b>6</b> Press the button T1  or T2  to view the dose. Pressing the button T3  , the dose value will blink. Use the button T1  or T2  to change the value, press the button T3  to confirm the desired value.
61B3 Mode CONTINUOUS	<b>7</b> Press the T3 button  to access the menu, then navigate using T1  and T2  to choose between , 3 SEC RINSE and CONTINUOUS, press the T3 button  to confirm the option.
Exit Group 1	<b>8</b> Press T1  or T2  until the display shows the exit menu, press the T3 button  to return to the “Barista” programming.





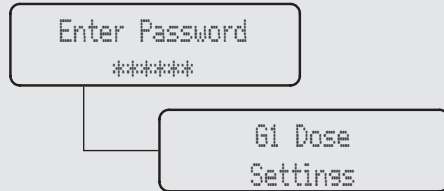

## “Technical” Programming

### Program Dose



### Description

- This parameter allows the operator to program the amount of coffee (brewing amount) for each button on the keyboard.
- The brewing amount can be set in terms of time (sec. ) or pulses. This number refers to the number of pulses that the flowmeter sends to the CPU.
- Once programmed, the button remains lighted.
- It is possible to set the dose for both a short and a long shot on the same key.
- The setting of the first group is automatically copied to the subsequent groups.
- It is possible to set each key individually, in this case the dose of the first group will no longer be used.
- It is possible to copy the doses of any key to the others.

Display	Operating Procedure
<div data-bbox="213 668 368 714" style="border: 1px solid black; padding: 2px; margin-bottom: 10px;">Group Dose Exit</div>	<p><b>9</b> Press T1  or T2  to continue with the programming of the other parameters.</p> <p><b>10</b> Press T1  or T2  to continue with the programming of the other parameters.</p>
<div data-bbox="213 927 368 973" style="border: 1px solid black; padding: 2px;">94.4      00:00 95.5    95.1    SB</div>	<p><b>11</b> Alternatively, you can exit the “Technical” programming and return to the normal use of the espresso machine by pressing T2  and T3  at the same time.</p>

## “Technical” Programming (only on ABR espresso machine models)

### Program Dose Scales

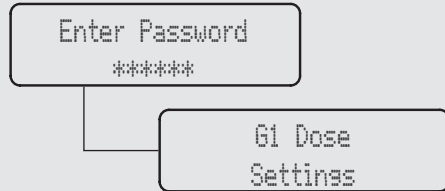

### Description

- This parameter allows the operator to view and manually change each dose for each key.
- For greater accuracy and consistency of the doses, it is recommended that you set each key.





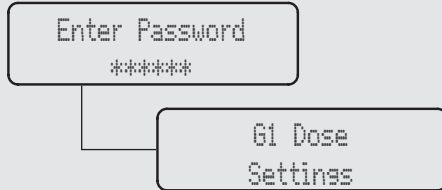















Display	Operating Procedure
	<b>1</b> After accessing the “Technical” programming menu and entering the password, use the buttons T1  and T2  until the following screen is displayed.
	<b>2</b> Press the button T1  or T2  to display the following menu.
	<b>3</b> Press the T3 button  to start the doses programming procedure.
	<b>4</b> Press the T3 button  to access the menu, then navigate using T1  and T2  to choose between PULSES, MASS and BREWRATIO, press the T3 button  to confirm the option.

## Program Dose Scales



### Description

- This parameter allows the operator to view and manually change each dose for each key.
- For greater accuracy and consistency of the doses, it is recommended that you set each key.

Display	Operating Procedure
G1B1 Brew Ratio 1:2.00	<b>5</b> Press the button T1  or T2  to view the dose of each key. Pressing the button T3  , the dose value will blink. Use the button T1  or T2  to change the value, press the button T3  to confirm the desired value.
G1 PF Mass 800.0g	<b>6</b> Press the button T1  or T2  to view the portafilter mass of each group. Pressing the button T3  , the value will blink. Use the button T1  or T2  to change the value, press the button T3  to confirm the desired value.
G1 Coffee Mass 14.0g	<b>7</b> Press the button T1  or T2  to view the coffee mass of each group. Pressing the button T3  , the value will blink. Use the button T1  or T2  to change the value, press the button T3  to confirm the desired value.
G1B3 Mode CONTINUOUS	<b>8</b> Press the button T3  to enter the menu, then navigate using T1  and T2  to choose between CONTINUOUS or 3 SEC RINS.

## “Technical” Programming (only on ABR espresso machine models)









### Program Dose Scales

Enter Password  
\*\*\*\*\*

G1 Dose  
Settings

### Description

- This parameter allows the operator to view and manually change each dose for each key.
- For greater accuracy and consistency of the doses, it is recommended that you set each key.





Display	Operating Procedure
<p>Exit GROUP 1</p>	<p><b>9</b> Press the button T3  to exit the submenu.</p>
<p>GROUP Dose Exit</p>	<p><b>10</b> Press T1  or T2  until the display shows the exit menu, press the T3 button  to return to the “Technical” programming.</p>
	<p><b>11</b> Press T1  or T2  to continue with the programming of the other parameters.</p>
<p>94.4      00:00 95.5   95.1   SB</p>	<p><b>12</b> Alternatively, you can exit the “Technical” programming and return to the normal use of the espresso machine by pressing T2  and T3  at the same time.</p>

### Program Dose

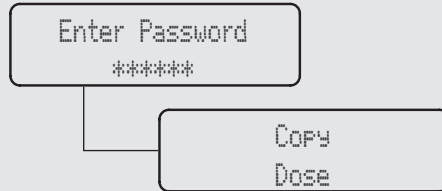
### Description

- This parameter allows the operator to copy the doses present of each key to the others.



Display	Operating Procedure
Enter Password *****	<b>1</b> After accessing the “Technical” programming menu and entering the password, use the buttons T1  and T2  until the following screen is displayed.
Group Dose Settings	<b>2</b> Press the button T1  or T2  to display the following menu.
COPY Dose	<b>3</b> Press the button T3  to start the dose copy procedure.
Push Button to COPY	<b>4</b> Press the key whose setting you want to copy. Now all the keys will flash.





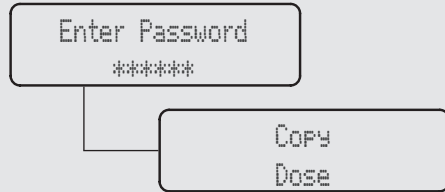

## “Technical” Programming

### Program Dose

### Description

- This parameter allows the operator to copy the doses present of each key to the others.



Display	Operating Procedure
<div style="border: 1px solid black; padding: 5px; margin-bottom: 10px;">           Push to Paste Enter to Exit         </div>	<b>5</b> Press the key where you want to paste the previously copied setting. Successful programming is indicated by the fixed lighting of the key. It is possible to repeat this procedure on any key.
<div style="border: 1px solid black; padding: 5px; margin-bottom: 10px;">           Group Dose Exit         </div>	<b>6</b> Press T1  or T2  until the display shows the exit menu, press the T3 button  to return to the “Barista” programming.
	<b>7</b> Press T1  or T2  to continue with the programming of the other parameters.
<div style="border: 1px solid black; padding: 5px;">           94.4      00:00            95.5    95.1    SB         </div>	<b>8</b> Alternatively, you can exit the “Technical” programming and return to the normal use of the espresso machine by pressing T2  and T3  at the same time.









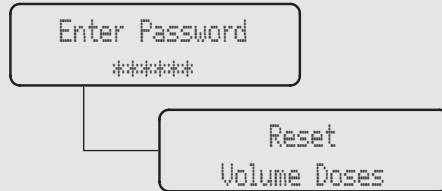

## “Technical” Programming

### Program Dose

### Description

- This parameter allows the operator to cancel all the doses set.



Display	Operating Procedure
Enter Password *****	<b>1</b> After accessing the “Technical” programming menu and entering the password, use the buttons T1  and T2  until the following screen is displayed.
Group Dose Settings	<b>2</b> Press the button T1  or T2  to display the following menu.
Reset Volume Doses	<b>3</b> Press the button T3  to confirm the procedure.
Resetting Doses...	Now all settings are cleared.
Group Dose Exit	<b>4</b> Press T1  or T2  until the display shows the exit menu, press the T3 button  to return to the “Barista” programming.

## “Technical” Programming





### Program Dose

### Description

- This parameter allows the operator to cancel all the doses set.

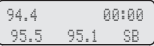
Enter Password  
\*\*\*\*\*

Reset  
Volume Doses









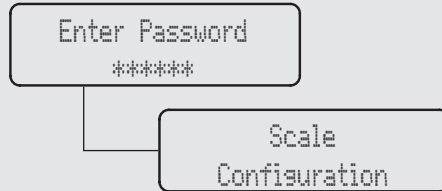

Display	Operating Procedure
	<p><b>5</b> Press T1  or T2  to continue with the programming of the other parameters.</p> <p><b>6</b> Alternatively, you can exit the “Technical” programming and return to the normal use of the espresso machine by pressing T2  and T3  at the same time.</p>

## Program Scales

### Description

- This parameter enables the technician to set some scale parameters like:
  - Enabling/disabling the offset parameter;
  - Setting the weight reading time;
  - Calibrating the scales;
  - Updating the scale software.



Display	Operating Procedure
<div style="border: 1px solid black; padding: 5px; width: fit-content;">                     Enter Password *****                 </div>	<p><b>1</b> After accessing the “Technical” programming menu and entering the password, use the buttons T1  and T2  until the following screen is displayed.</p>
<div style="border: 1px solid black; padding: 5px; width: fit-content;">                     Scale Configuration                 </div>	<p><b>2</b> Press the T3 button  to enter the menu.</p>
<div style="border: 1px solid black; padding: 5px; width: fit-content;">                     Auto Offset ENABLED                 </div>	<p><b>3</b> Press the T3 button  to enter the menu, move between the parameters using the buttons T1  and T2  to select <b>ENABLED</b> or <b>DISABLED</b>, press the T3 button  to confirm the option.</p>
<div style="border: 1px solid black; padding: 5px; width: fit-content;">                     Scale Tare Time 3s                 </div>	<p><b>4</b> Press the T3 button  to enter the menu, navigate the parameters using the buttons T1  and T2  to set the desired value. This parameter is common to all groups.</p>





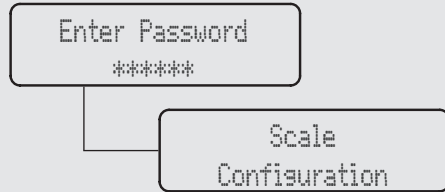

## “Technical” Programming (only on ABR espresso machine models)

### Program Scales



### Description

- This parameter enables the technician to set some scale parameters like:
  - Enabling/disabling the offset parameter;
  - Setting the weight reading time;
  - Calibrating the scales;
  - Updating the scale software.



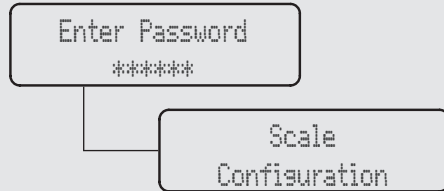

Display	Operating Procedure
G1 Scale PRESENT	<b>5</b> This parameter indicates that the scale is properly connected; navigate using the T1  and T2  buttons to display the next menu.
Calibrate G1 Scale	<b>6</b> Press the T3 button  to start the calibration procedure.
Empty G1 Scale And Press Enter	Remove any object from the scale, then press the T3 button  to confirm.
Place 100s on G1 And Press Enter	<b>7</b> Place the reference weights onto the scale, then press the T3 button  to confirm. At the end of the process, the self-calibration values or a confirmation message are displayed. Repeat this operation for each group.
G1 Scale: v0.0.0 Upgrade to 0.0.0	<b>8</b> Press T2  to proceed with setting and press the T3 button  to update the scale firmware if necessary.

## Program Scales

### Description



- This parameter enables the technician to set some scale parameters like:
  - Enabling/disabling the offset parameter;
  - Setting the weight reading time;
  - Calibrating the scales;
  - Updating the scale software.

Display	Operating Procedure
<div style="border: 1px solid black; padding: 2px; margin-bottom: 2px;">Start Scale Testing</div> <div style="border: 1px solid black; padding: 2px; margin-bottom: 2px;">0.0 0.0 0.0 Enter to Exit</div>	<b>9</b> Press the T3 button  to enter the menu and place the reference weights onto the scale.
<div style="border: 1px solid black; padding: 2px; margin-bottom: 2px;">View Scale Versions</div>	<b>10</b> Press the T3 button  to enter the menu.
<div style="border: 1px solid black; padding: 2px; margin-bottom: 2px;">G1 Scale HW0.0 FW0.0.0</div>	<b>11</b> Use T1  and T2  to display the hardware and software version installed.
<div style="border: 1px solid black; padding: 2px; margin-bottom: 2px;">View Versions Exit</div>	<b>12</b> Press the T3 button  to exit the submenu





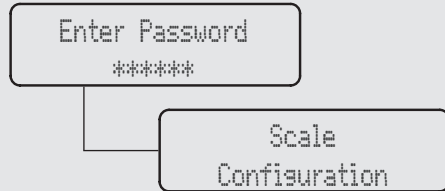

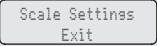

## “Technical” Programming (only on ABR espresso machine models)

### Program Scales

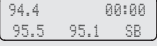

### Description

- This parameter enables the technician to set some scale parameters like:
  - Enabling/disabling the offset parameter;
  - Setting the weight reading time;
  - Calibrating the scales;
  - Updating the scale software.

Display	Operating Procedure
	<p><b>13</b> Press T1  or T2  until the display shows the exit menu, press the T3 button  to return to the “Technical” programming.</p> <p><b>14</b> Press T1  or T2  to continue with the programming of the other parameters.</p>
	<p><b>15</b> Alternatively, you can exit the “Technical” programming and return to the normal use of the espresso machine by pressing T2  and T3  at the same time.</p>









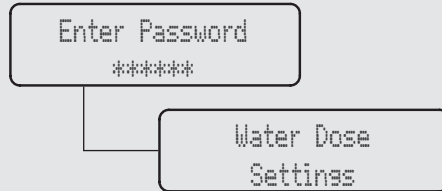

## “Technical” Programming

### Water Dose

#### Description

- This parameter allows the operator to program the amount of water (brewing amount) for the hot water button.
- This feature can be enabled or disabled.



Display	Operating Procedure
Enter Password *****	<b>1</b> After accessing the “Technical” programming menu and entering the password, use the buttons T1  and T2  until the following screen is displayed.
Water Dose Settings	<b>2</b> Press the T3 button  to enter the menu.
Water Dose WITH PUMP	<b>3</b> Press the T3 button  to enter the menu, move between the parameters using the buttons T1  and T2  to select WITH PUMP or WITHOUT PUMP, press the T3 button  to confirm the option.
Water Dose ENABLED	<b>4</b> Press the T3 button  to enter the menu, move between the parameters using the buttons T1  and T2  to select ENABLED or DISABLED, press the T3 button  to confirm the option.





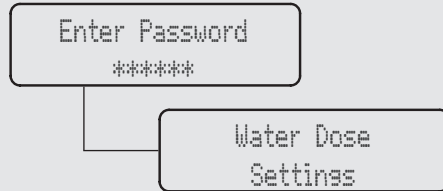

## “Technical” Programming

### Water Dose

### Description

- This parameter allows the operator to program the amount of water (brewing amount) for the hot water button.
- This feature can be enabled or disabled.



Display	Operating Procedure
Program Water Dose Program Long Water Dose	<b>5</b> You can set two doses on the hot water button by selecting either <code>Water Dose</code> or <code>Long Water Dose</code> . Press T3 button  to start the dose setting procedure.
Program Water Dose Press Water Button To Stop Press Water Button To Program Water Dose Saved 5.0 Seconds	<b>6</b> To program the brewing time, press the hot water button to start and then press it again to stop when the desired dose is achieved. Now the saved brewing time is displayed.
Water Dose 5.0s	<b>7</b> Press T1  or T2  to display the dose of the hot water button. Pressing the button T3 button  , the dose value will blink. Use the button T1  or T2  to change the value, press the button T3 button  to confirm the desired value.











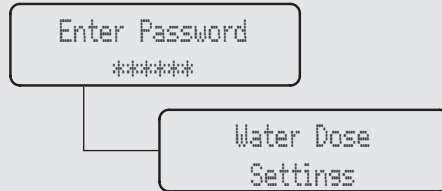



## “Technical” Programming

### Water Dose

#### Description

- This parameter allows the operator to program the amount of water (brewing amount) for the hot water button.
- This feature can be enabled or disabled.



Display	Operating Procedure
Long Water Dose 10.0s	<b>8</b> Press T1  or T2  to display the long dose of the hot water button. Pressing the button T3 button  , the dose value will blink. Use the button T1  or T2  to change the value, press the button T3 button  to confirm the desired value.
Water Dose Exit	<b>9</b> Press the T3 button  to return to the “Technical” programming.
	<b>10</b> Press T1  or T2  to continue with the programming of the other parameters.
Exit Menu	<b>11</b> To exit the menu move between the parameters using the buttons T1  and T2  until the exit menu is displayed. Press the T3 button  to exit the menu and return to the normal use of the espresso machine.

## “Technical” Programming

### Water Dose

### Description

- This parameter allows the operator to program the amount of water (brewing amount) for the hot water button.
- This feature can be enabled or disabled.

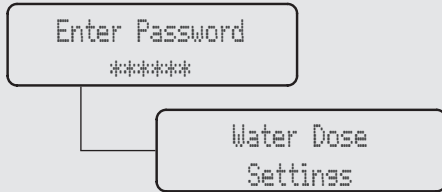

Display	Operating Procedure
	<p><b>12</b> Alternatively, you can exit the “Technical” programming and return to the normal use of the espresso machine by pressing T2  and T3  at the same time.</p>

## “Technical” Programming

### Coffee Boiler

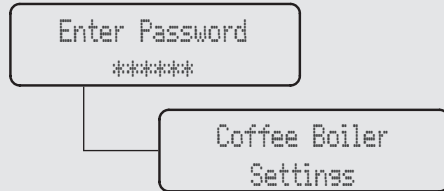

### Description

- This parameter enables the technician to set various parameters of the coffee boiler.
- The temperature of the boiler is measured at the most critical point in the boiler where temperature fluctuation is the greatest.
- The temperature of the water exiting the group head is held constant by means of the mass of the group casting. Even

though the temperature of the boiler may vary slightly, the temperature of the water exiting the group is constant.

- To properly calibrate the temperature of any espresso machine it is import to measure the temperature of the water exiting the group by means of an external temperature measuring device. The difference of the display temperature and the measured temperature may be compensated by use of the “Coffee T. Offset” parameter.

Display	Operating Procedure
	<b>1</b> After accessing the “Technical” programming menu and entering the password, use the buttons T1  and T2  until the following screen is displayed.
	<b>2</b> Press the T3 button  to enter the menu.
	<b>3</b> Press the T3 button  to enter the menu, move between the parameters using the buttons T1  and T2  to select <b>ENABLED</b> or <b>DISABLED</b> , press the T3 button  to confirm the option.
	<b>4</b> Press the T3 button  to enter the menu, move with the buttons T1  and T2  to set the desired temperature, press the T3 button  to confirm the value. In the case of espresso machine with multiple boilers you can set the temperature also on the coffee boiler. The temperature indicated on the left is the actual temperature of the group while the temperature on the right is the set temperature.





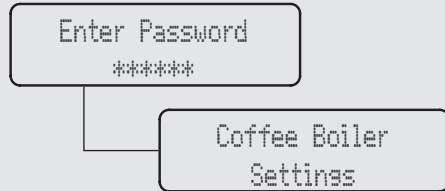





## “Technical” Programming

### Coffee Boiler



### Description

- The OFFSET parameter is used to calibrate the coffee boiler temperature system to ensure the display temperature accurately represents the temperature of the water exiting the group head.
- This parameter is preset at the factory based upon initial tests of this espresso machine.
- It is not recommended that this number is changed. Changes to this parameter can cause unexpected results.
- It is important to write down this value before making changes to be sure you can return to the factory programming if unexpected results occur. Each machine may have a different value as it is set individually.

Display	Operating Procedure
<div style="border: 1px solid black; padding: 5px; width: fit-content;">           CB1 Offset 3.0°C         </div>	<b>5</b> Press the T3 button  to enter the menu, move with the buttons T1  and T2  to set the desired temperature, press the T3 button  to confirm the value. In the case of espresso machine with 4 groups you can set this value also on the coffee boiler 2.
<div style="border: 1px solid black; padding: 5px; width: fit-content;">           CB1 RTD Trim 0         </div>	<b>6</b> Press the T3 button  to enter the menu, move between the parameters with the buttons T1  and T2  to set the desired value, press the T3 button  to confirm the value.
<div style="border: 1px solid black; padding: 5px; width: fit-content;">           CB Settings Exit         </div>	<b>7</b> Press the T3 button  to return to the “Technical” programming.
	<b>8</b> Press T1  or T2  to continue with the programming of the other parameters.

## “Technical” Programming

### Coffee Boiler

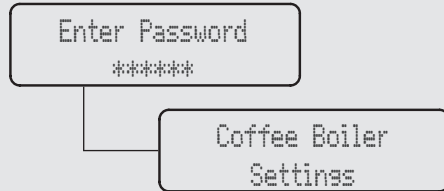





### Description

- The OFFSET parameter is used to calibrate the coffee boiler temperature system to ensure the display temperature accurately represents the temperature of the water exiting the group head.
- This parameter is preset at the factory based upon initial tests of this espresso machine.
- It is not recommended that this number is changed. Changes to this parameter

can cause unexpected results.

- It is important to write down this value before making changes to be sure you can return to the factory programming if unexpected results occur. Each machine may have a different value as it is set individually.

Display	Operating Procedure
<div style="border: 1px solid black; padding: 5px; text-align: center;">Exit Menu</div>	<p><b>9</b> To exit the menu move between the parameters using the buttons T1  and T2  until the exit menu is displayed. Press the T3 button  to exit the menu and return to the normal use of the espresso machine.</p>
<div style="border: 1px solid black; padding: 5px; text-align: center;">           94.4      00:00            95.5    95.1    88         </div>	<p><b>10</b> Alternatively, you can exit the “Technical” programming and return to the normal use of the espresso machine by pressing T2  and T3  at the same time.</p>

**WARNING**

THE COFFEE BOILER CONTAINS WATER AT ELEVATED TEMPERATURES.  
 WATER TEMPERATURE OVER 52°C CAN CAUSE SEVERE BURNS INSTANTLY OR DEATH FROM SCALDING.

## “Technical” Programming

### Steam Boiler

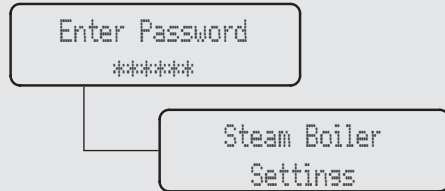

### Description

- This parameter enables the technician to set various parameters of the steam boiler.
- The temperature of saturated water is proportional to the pressure inside the Steam Boiler. Therefore it is possible to regulate the pressure of the steam boiler by means of electronic temperature control. Please use the following tables as reference when setting the steam boiler temperature.

Temperature	Pressure
247°F/119°C	1.0 bar
260°F/127°C	1.5 bar
264°F/129°C	2.0 bar

Display	Operating Procedure
	<b>1</b> After accessing the “Technical” programming menu and entering the password, use the buttons T1  and T2  until the following screen is displayed.
	<b>2</b> Press the T3 button  to enter the menu.
	<b>3</b> Press the T3 button  to enter the menu, move between the parameters using the buttons T1  and T2  to select <b>ENABLED</b> or <b>DISABLED</b> , press the T3 button  to confirm the option.
	<b>4</b> Press the T3 button  to enter the menu, move with the buttons T1  and T2  to set the desired temperature, press the T3 button  to confirm the value.

## “Technical” Programming

### Steam Boiler

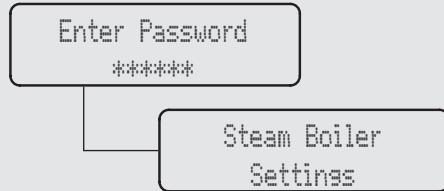

















### Description

- The parameter filling WITH PUMP allows the technician to select the activation of the water pump during the automatic filling cycle of the service boiler.
- Only under unusual circumstances would the option of “WITHOUT PUMP” be chosen.
- The electronics installed in this espresso machine give priority to the brew boiler for pressure. The activation of the auto-fill cycle during the brewing

process can reduce the overall dispensing pressure in the brew boiler.

- During the auto-fill cycle, if a brew cycle is chosen, the auto-fill cycle is delayed until all brew cycles are complete.
- The maximum permitted value for the temperature setting is 129°C.
- SAFETY TEST allows to bring the steam boiler temperature to 140°C, thus triggering the safety valve. Once the

Display	Operating Procedure
Autofill Delay 2 start 2 stop	<b>5</b> The first value indicates the time in seconds between the detection of the need to fill and the start of filling. The second value indicates the time in seconds between filling and its actual end. Press the T3 button  to enter the menu, move with the buttons T1  and T2  to set the desired automatic filling time, press the T3 button  to confirm the value.
Fill During Brew YES	<b>6</b> Press the T3 button  to enter the menu, move using the buttons T1  and T2  to select YES or NO, press the T3 button  to confirm the option.
Autofill Timeout 10 min	<b>7</b> Press the T3 button  to enter the menu, move with the buttons T1  and T2  to set the desired time, press the T3 button  to confirm the value.
Fill With Pump WITH PUMP	<b>8</b> Press the T3 button  to enter the menu, move between the parameters using the buttons T1  and T2  to select WITH PUMP or WITHOUT PUMP, press the T3 button  to confirm the option.

## “Technical” Programming



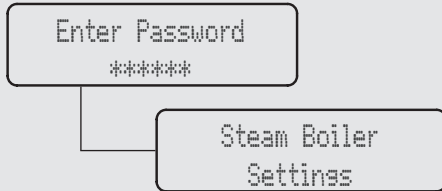



### Steam Boiler



### Description

- valve has triggered disable the function.
- Should the safety valve fail to trigger within approximately one minute of the temperature reaching 140°C, disable the function and replace the valve.
- Only qualified technicians can perform this operation.
- DRAIN STEAM BOILER allows the service staff to renew or “regenerate” the water contained inside the steam

- boiler, discharging about one half of the water contained in the boiler.
- This procedure is recommended in case the machine should remain inactive for more than 8 hours and in any case at least on a weekly basis.





Display	Operating Procedure
Level Sensitiv. HIGH	9 Press the T3 button  to enter the menu, move between the parameters using the buttons T1  and T2  to select HIGH, MEDIUM or LOW, press the T3 button  to confirm the option.
Steam Boiler Safety Test	10 Press the T3 button  to enable the function.
SB 124.3/140.0°C Enter to Exit	11 Press the T3 button  to exit the function.
Drain Steam Boiler	12 Press the T3 button  to enable the function. Manually close the mixing valve to allow the drain of the water contained in the steam boiler.
Close Water Valve Enter when Ready	

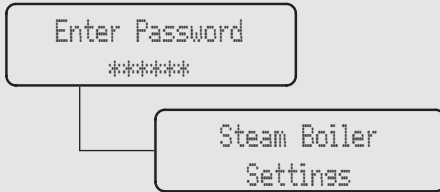

## Steam Boiler

### Description



Display	Operating Procedure
Press Water Button Enter when Empty	Press the hot water button to start draining the water contained in the steam boiler. Press the T3 button  when the boiler is empty, wait for refilling completion.
Wait for Steam Boiler Autofill	
Reset Water Valve Enter when Done	Manually reopen the mixing valve and press the T3 button  .
Drain Steam Boiler Completed	Now the procedure to renew or “regenerate” the water inside the steam boiler is completed
SB Settings Exit	<b>13</b> Press the T3 button  to return to the “Technical” programming.
	<b>14</b> Press T1  or T2  to continue with the programming of the other parameters.





## “Technical” Programming

### Steam Boiler

### Description

Enter Password  
\*\*\*\*\*

Steam Boiler  
Settings

Display	Operating Procedure
<p>Exit Menu</p>	<p><b>15</b> To exit the menu move between the parameters using the buttons T1  and T2  until the exit menu is displayed. Press the T3 button  to exit the menu and return to the normal use of the espresso machine.</p>
<p>94.4      00:00 95.5    95.1   SB</p>	<p><b>16</b> Alternatively, you can exit the “Technical” programming and return to the normal use of the espresso machine by pressing T2  and T3  at the same time.</p>



### WARNING



THE STEAM BOILER CONTAINS WATER AT ELEVATED TEMPERATURES.  
WATER TEMPERATURE OVER 52°C CAN CAUSE SEVERE BURNS INSTANTLY OR DEATH FROM SCALDING.





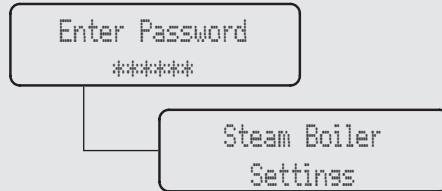





## “Technical” Programming

### Steam Boiler



### Description

- The parameter “Level Sensit.” allows the technician to select the probe sensitivity for steam boiler filling according to water hardness.
- The black connection cable corresponds to the working level probe.
- The red connection cable corresponds to the minimum level probe.
- The sensitivity default value is high.

Display	Operating Procedure
Enter Password *****	<b>1</b> After accessing the “Technical” programming menu and entering the password, use the buttons T1  and T2  until the following screen is displayed.
Steam Boiler Settings	<b>2</b> Press the T3 button  to enter the menu.
Level Sensitiv. HIGH	<b>3</b> Press the T3 button  to enter the menu, move between the parameters using the buttons T1  and T2  to select HIGH, MEDIUM or LOW, press the T3 button  to confirm the option.
SB Settings Exit	<b>4</b> To exit the submenu move between the parameters using the buttons T1  and T2  until the exit submenu is displayed. Press the T3 button  to exit the submenu.

## “Technical” Programming



### Steam Boiler

Enter Password  
\*\*\*\*\*

Steam Boiler  
Settings

### Description

- The parameter “Level Sensit.” allows the technician to select the probe sensitivity for steam boiler filling according to water hardness.
- The black connection cable corresponds to the working level probe.
- The red connection cable corresponds to the minimum level probe.
- The sensitivity default value is high.

Display	Operating Procedure
<p>Exit Menu</p> <p>Restart Machine for Chances</p>	<p><b>5</b> To exit the menu move between the parameters using the buttons T1  and T2  until the exit menu is displayed. Press the T3 button  to exit the menu.</p>
<p></p>	<p><b>6</b> Turn the Main Switch to the 0 position.</p>
<p>94.4 00:00 95.5 95.1 SB</p>	<p><b>7</b> Now it is possible to turn on again the espresso machine; set the main switch to position 1 and press any button to complete machine switch on.</p>

## “Technical” Programming

### Pre-Infusion or Pre-Brewing

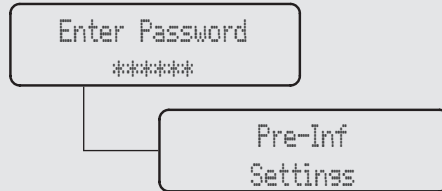

### Description

- This parameter allows the operator to program the time of pre-brewing of water with the coffee. Each group can have a different programming.
- Pre-brewing has only two values to be adjusted for each group. The time (in seconds) for which the brewing valve is open during the pre-brewing cycle and the time (in seconds) for which the brewing valve is closed during the

pre-brewing cycle; during this time the pump is active. Once the pre-brewing cycle is over, the normal brewing cycle will continue until the end.

- For an espresso machine composed of three groups, they are identified as Group 1, Group 2 and Group 3.

Display	Operating Procedure
Enter Password *****	<ol style="list-style-type: none"> <li>1 After accessing the “Technical” programming menu and entering the password, use the buttons T1  and T2  until the following screen is displayed.</li> <li>2 Press the T3 button  to enter the menu.  Press T1  or T2  to select the group whose parameters you want to set.</li> <li>3 By pressing the T3 button  the first value will blink. Use the buttons T1  and T2  to reach the value that you want to set, press T3 button  to confirm. Repeat this operation to set the second value.</li> <li>4 To exit the submenu move between the parameters using the buttons T1  and T2  until the exit submenu is displayed. Press the T3 button  to exit the submenu.</li> </ol>
Pre-Inf Settings	
Group 1 Pre-Wet 0s Wet 0s Hold	
Pre-Wet Settings Exit	

## “Technical” Programming

### Pre-Infusion or Pre-Brewing

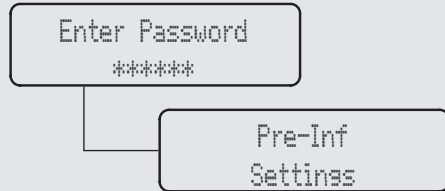









### Description

- This parameter allows the operator to program the time of pre-brewing of water with the coffee. Each group can have a different programming.
- Pre-brewing has only two values to be adjusted for each group. The time (in seconds) for which the brewing valve is open during the pre-brewing cycle and the time (in seconds) for which the brewing valve is closed during the

pre-brewing cycle; during this time the pump is active. Once the pre-brewing cycle is over, the normal brewing cycle will continue until the end.

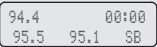
- For an espresso machine composed of three groups, they are identified as Group 1, Group 2 and Group 3.

Display	Operating Procedure
	<p><b>5</b> Press T1  or T2  to continue with the programming of the other parameters.</p> <p><b>6</b> To exit the menu move between the parameters using the buttons T1  and T2  until the exit menu is displayed. Press the T3 button  to exit the menu and return to the normal use of the espresso machine.</p>
	<p><b>7</b> Alternatively, you can exit the “Technical” programming and return to the normal use of the espresso machine by pressing T2  and T3  at the same time.</p>







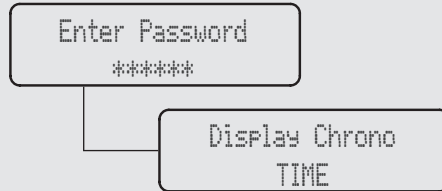

## “Technical” Programming

### Crono Function

### Description

- When enabled, this parameter displays a timer that times each shot.
- The timer is reset each time a button on the keypad is pressed.
- If enabled, the Chrono function is permanently displayed during brewing, while during wait state it alternates with the programmable name.



Display	Operating Procedure
<div style="border: 1px solid black; padding: 5px; width: fit-content;">           Enter Password *****         </div>	<p><b>1</b> After accessing the “Technical” programming menu and entering the password, use the buttons T1  and T2  until the following screen is displayed.</p>
<div style="border: 1px solid black; padding: 5px; width: fit-content;">           Display Chrono TIME         </div>	<p><b>2</b> Press the T3 button  to enter the menu, move between the parameters using the buttons T1  and T2  to select an option (NO/TIME/DOSE), press the T3 button  to confirm the option.</p>
<div style="border: 1px solid black; padding: 5px; width: fit-content;">           GR1 GR2 GR3 18 0 0         </div>	<p><b>3</b> In the case of active option (TIME or DOSE ) the display shown to the side appears.</p>
	<p><b>4</b> Press T1  or T2  to continue with the programming of the other parameters.</p>



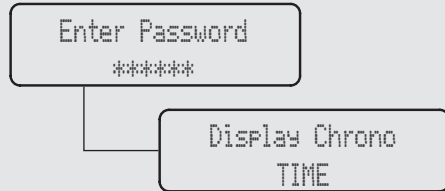

## “Technical” Programming

### Crono Function



### Description

- When enabled, this parameter displays a timer that times each shot.
- The timer is reset each time a button on the keypad is pressed.
- If enabled, the Chrono function is permanently displayed during brewing, while during wait state it alternates with the programmable name.

Display	Operating Procedure
<div style="border: 1px solid black; padding: 5px; width: fit-content; margin-bottom: 10px;">Exit Menu</div>	<p><b>5</b> To exit the menu move between the parameters using the buttons T1  and T2  until the exit menu is displayed. Press the T3 button  to exit the menu and return to the normal use of the espresso machine.</p>
<div style="border: 1px solid black; padding: 5px; width: fit-content;">           94.4      00:00            95.5   95.1   SB         </div>	<p><b>6</b> Alternatively, you can exit the “Technical” programming and return to the normal use of the espresso machine by pressing T2  and T3  at the same time.</p>







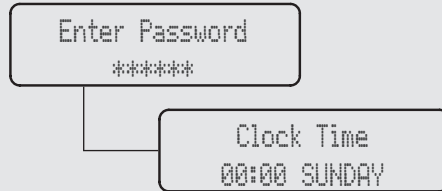





## “Technical” Programming

### Clock Adjust



### Description

- This parameter allows the user to set the time of day and the day of the week.
- This parameter is used to display time and is also used by the “Auto On/Off” parameter
- There are 4 changeable values within this parameter:
  - Hour;
  - Minute;
  - Day of week;
  - Hour Format 12h or 24h.

Display	Operating Procedure
<div style="border: 1px solid black; padding: 5px; width: fit-content;">           Enter Password *****         </div>	<b>1</b> After accessing the “Technical” programming menu and entering the password, use the buttons T1  and T2  until the following screen is displayed.
<div style="border: 1px solid black; padding: 5px; width: fit-content;">           Clock Time 00:00 SUNDAY         </div>	<b>2</b> Pressing the T3 button  the first value will blink. Use the buttons T1  and T2  to set the clock. Repeat the operation to set the day of the week.
<div style="border: 1px solid black; padding: 5px; width: fit-content;">           Exit Menu         </div>	<b>3</b> Press T1  or T2  to continue with the programming of the other parameters.
	<b>4</b> To exit the menu move between the parameters using the buttons T1  and T2  until the exit menu is displayed. Press the T3 button  to exit the menu and return to the normal use of the espresso machine.

## “Technical” Programming



### Clock Adjust

Enter Password  
\*\*\*\*\*

Clock Time  
00:00 SUNDAY

### Description

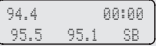
- This parameter allows the user to set the time of day and the day of the week.
- This parameter is used to display time and is also used by the “Auto On/Off” parameter
- There are 4 changeable values within this parameter:
  - Hour;
  - Minute;
  - Day of week;
  - Hour Format 12h or 24h.

Display	Operating Procedure
 <p>94.4 00:00 95.5 95.1 SB</p>	<p><b>5</b> Alternatively, you can exit the “Technical” programming and return to the normal use of the espresso machine by pressing T2  and T3  at the same time.</p>

## “Technical” Programming

### Cup Warmer

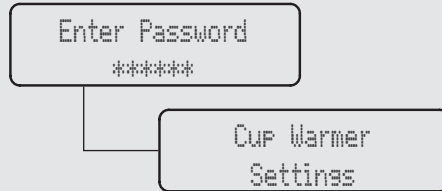

### Description

- This parameter allows the technician to enable or disable the cups heating function.
- This parameter allows the technician to adjust the operating time of the resistance for the heating of the cups.
- This parameter allows the technician to select the operating of the cup warmer by time or by button on the control panel.
- This function is displayed only on the models of espresso machine equipped with this accessory.

Display	Operating Procedure
Enter Password *****	1 After accessing the “Technical” programming menu and entering the password, use the buttons T1  and T2  until the following screen is displayed.
Cup Warmer Settings	2 Press the T3 button  to enter the menu.
Cup Warmer DISABLED	3 Press the T3 button  to enter the menu, move between the parameters using the buttons T1  and T2  to select <b>ENABLED</b> or <b>DISABLED</b> , press the T3 button  to confirm the option.
Cup Warmer TIME	4 Press the T3 button  to enter the menu, move between the parameters using the buttons T1  and T2  to select <b>TIME</b> or <b>BY BUTTON</b> , press the T3 button  to confirm the option.





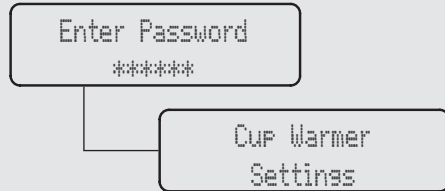







## “Technical” Programming

### Cup Warmer



### Description

- This parameter allows the technician to enable or disable the cups heating function.
- This parameter allows the technician to adjust the operating time of the resistance for the heating of the cups.
- This parameter allows the technician to select the operating of the cup warmer by time or by button on the control panel.
- This function is displayed only on the models of espresso machine equipped with this accessory.

Display	Operating Procedure
<div style="border: 1px solid black; padding: 2px; margin-bottom: 5px;">Cup Warmer T On 2min</div> <div style="border: 1px solid black; padding: 2px; margin-bottom: 5px;">Cup Warmer T Off 8min</div> <div style="border: 1px solid black; padding: 2px; margin-bottom: 5px;">CUP Warmer Exit</div> <div style="border: 1px solid black; padding: 2px; margin-bottom: 5px;">Exit Menu</div>	<p><b>5</b> Press the T3 button  to enter the menu, move between the parameters with the buttons T1  and T2  to set the desired time, press the T3 button  to confirm the value.</p> <p><b>6</b> To exit the submenu move between the parameters using the buttons T1  and T2  until the exit submenu is displayed. Press the T3 button  to exit the submenu.</p> <p><b>7</b> Press T1  or T2  to continue with the programming of the other parameters.</p> <p><b>8</b> To exit the menu move between the parameters using the buttons T1  and T2  until the exit menu is displayed. Press the T3 button  to exit the menu and return to the normal use of the espresso machine.</p>

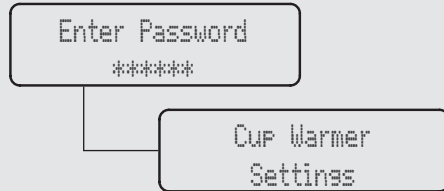

## “Technical” Programming

### Cup Warmer



### Description

- This parameter allows the technician to enable or disable the cups heating function.
- This parameter allows the technician to adjust the operating time of the resistance for the heating of the cups.
- This parameter allows the technician to select the operating of the cup warmer by time or by button on the control panel.
- This function is displayed only on the models of espresso machine equipped with this accessory.

Display	Operating Procedure
<div data-bbox="213 668 370 714" style="border: 1px solid black; padding: 2px; width: fit-content;">           94.4      00:00            95.5    95.1    SB         </div>	<p>9 Alternatively, you can exit the “Technical” programming and return to the normal use of the espresso machine by pressing T2  and T3  at the same time.</p>





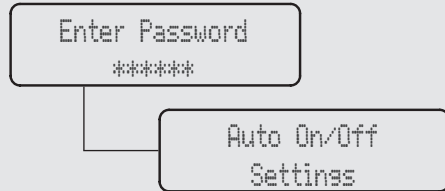





## “Technical” Programming

### Auto ON/OFF



### Description

- This parameter allows the technician to program the espresso machine to turn on at a preset time and turn off at a preset time.
- This feature also allows the espresso machine to remain in the off condition for one repeating closed day.

Display	Operating Procedure
Enter Password *****	<b>1</b> After accessing the “Technical” programming menu and entering the password, use the buttons T1  and T2  until the following screen is displayed.
Auto On/Off Settings	<b>2</b> Press the T3 button  to enter the menu.
Auto On/Off ENABLED	<b>3</b> Press the T3 button  to enter the menu, move between the parameters using the buttons T1  and T2  to select <b>ENABLED</b> or <b>DISABLED</b> , press the T3 button  to confirm the option.
Auto On Time 00:00	<b>4</b> If the parameter is enabled, press the T3 button  to enter the menu, move with the buttons T1  and T2  to set the desired time, press the T3 button  to confirm the value.





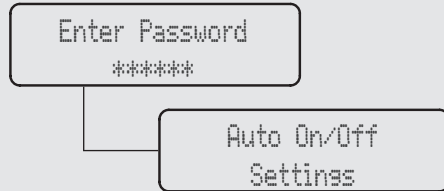







## “Technical” Programming

### Auto ON/OFF



### Description

- This parameter allows the technician to program the espresso machine to turn on at a preset time and turn off at a preset time.
- This feature also allows the espresso machine to remain in the off condition for one repeating closed day.

Display	Operating Procedure
Auto Off Time 00:00	<b>5</b> Press the T3 button  to enter the menu, move with the buttons T1  and T2  to set the desired time, press the T3 button  to confirm the value.
Closed On NEVER	<b>6</b> Press the T3 button  to enter the menu, move with the buttons T1  and T2  to select an option, press the T3 button  to confirm the option.
Auto On/Off Exit	<b>7</b> To exit the submenu move between the parameters using the buttons T1  and T2  until the exit submenu is displayed. Press the T3 button  to exit the submenu.
	<b>8</b> Press T1  or T2  to continue with the programming of the other parameters.



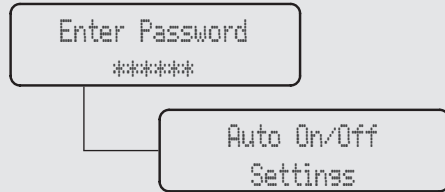

## “Technical” Programming

### Auto ON/OFF



### Description

- This parameter allows the technician to program the espresso machine to turn on at a preset time and turn off at a preset time.
- This feature also allows the espresso machine to remain in the off condition for one repeating closed day.

Display	Operating Procedure
<div data-bbox="178 668 333 714" style="border: 1px solid black; padding: 5px; text-align: center;">Exit Menu</div>	<p><b>9</b> To exit the menu move between the parameters using the buttons T1  and T2  until the exit menu is displayed. Press the T3 button  to exit the menu and return to the normal use of the espresso machine.</p>
<div data-bbox="178 800 333 846" style="border: 1px solid black; padding: 5px;">           94.4      00:00            95.5   95.1   SB         </div>	<p><b>10</b> Alternatively, you can exit the “Technical” programming and return to the normal use of the espresso machine by pressing T2  and T3  at the same time.</p>











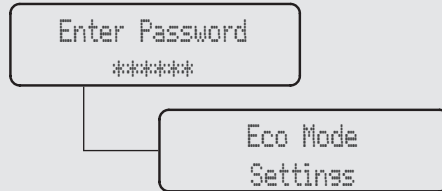



## “Technical” Programming

### ECO Mode

### Description

- This parameter allows the technician to set up a temperature to be maintained in case of a temporary non utilization of the espresso machine.
- It is possible to set this parameter also during the normal operation of the machine by pressing T1 and T2 at the same time.



Display	Operating Procedure
<div style="border: 1px solid black; padding: 5px; width: fit-content;">                     Enter Password *****                 </div>	<b>1</b> After accessing the “Technical” programming menu and entering the password, use the buttons T1  and T2  until the following screen is displayed.
<div style="border: 1px solid black; padding: 5px; width: fit-content;">                     Eco Mode Settings                 </div>	<b>2</b> Press the T3 button  to enter the menu.
<div style="border: 1px solid black; padding: 5px; width: fit-content;">                     Eco Mode Temp -10.0°C                 </div>	<b>3</b> Press the T3 button  to enter the menu, move between the parameters with the buttons T1  and T2  to set the desired temperature, press the T3 button  to confirm the value.
<div style="border: 1px solid black; padding: 5px; width: fit-content;">                     Auto Eco Time 30                 </div>	<b>4</b> Press the T3 button  to enter the menu, move between the parameters with the buttons T1  and T2  to set the desired time (in minutes), press the T3 button  to confirm the value. A value of “0” (zero) disables the Eco Mode parameter.





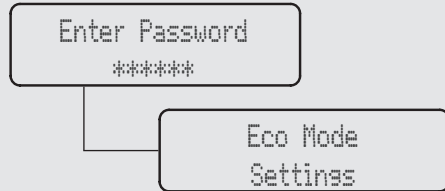







## “Technical” Programming

### ECO Mode



### Description

- This parameter allows the technician to set up a temperature to be maintained in case of a temporary non utilization of the espresso machine.
- It is possible to set this parameter also during the normal operation of the machine by pressing T1 and T2 at the same time.

Display	Operating Procedure
<div style="border: 1px solid black; padding: 5px; margin-bottom: 10px;">           Btn Shortcut B1+B2         </div>	<b>5</b> Press the T3 button  to enter the menu, move between the parameters using the buttons T1  and T2  to select B1+B2 or DISABLED, press the T3 button  to confirm the option.
<div style="border: 1px solid black; padding: 5px; margin-bottom: 10px;">           Eco Mode Exit         </div>	<b>6</b> To exit the submenu move between the parameters using the buttons T1  and T2  until the exit submenu is displayed. Press the T3 button  to exit the submenu.
<div style="border: 1px solid black; padding: 5px; margin-bottom: 10px;">           Exit Menu         </div>	<b>7</b> To exit the menu move between the parameters using the buttons T1  and T2  until the exit menu is displayed. Press the T3 button  to exit the menu and return to the normal use of the espresso machine.
<div style="border: 1px solid black; padding: 5px;">           94.4      00:00            95.5    95.1    SB         </div>	<b>8</b> Alternatively, you can exit the “Technical” programming and return to the normal use of the espresso machine by pressing T2  and T3  at the same time.







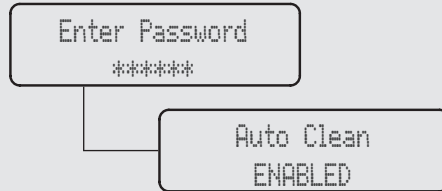

## “Technical” Programming

### Auto Clean

#### Description

- This parameter allows the technician to enable or disable the auto clean function.
- If the autoclean function is enabled in the menu, steam will be delivered by the group with a delay of 2 seconds form portafilter removal.



Display	Operating Procedure
<p>Enter Password *****</p>	<p>1 After accessing the “Technical” programming menu and entering the password, use the buttons T1  and T2  until the following screen is displayed.</p>
<p>Auto Clean DISABLED</p>	<p>2 Press the T3 button  to enter the menu, move between the parameters using the buttons T1  and T2  to select <b>ENABLED</b> or <b>DISABLED</b> , press the T3 button  to confirm the option.</p>
	<p>3 Press T1  or T2  to continue with the programming of the other parameters.</p>

**WARNING**

THE STEAM HAS ELEVATED TEMPERATURES.  
WATER TEMPERATURE OVER 52°C CAN CAUSE SEVERE BURNS INSTANTLY OR DEATH FROM SCALDING.

## “Technical” Programming





### Auto Clean

Enter Password  
\*\*\*\*\*

Auto Clean  
ENABLED

### Description

- This parameter allows the technician to enable or disable the auto clean function.
- If the autoclean function is enabled in the menu, steam will be delivered by the group with a delay of 2 seconds form portafilter removal.

Display	Operating Procedure
<p>Exit Menu</p>	<p><b>4</b> To exit the menu move between the parameters using the buttons T1  and T2  until the exit menu is displayed. Press the T3 button  to exit the menu and return to the normal use of the espresso machine.</p>
<p>94.4      00:00 95.5   95.1   SB</p>	<p><b>5</b> Alternatively, you can exit the “Technical” programming and return to the normal use of the espresso machine by pressing T2  and T3  at the same time.</p>

**⚠ WARNING ⚠**

**THE STEAM HAS ELEVATED TEMPERATURES.  
WATER TEMPERATURE OVER 52°C CAN CAUSE SEVERE BURNS INSTANTLY OR DEATH FROM SCALDING.**







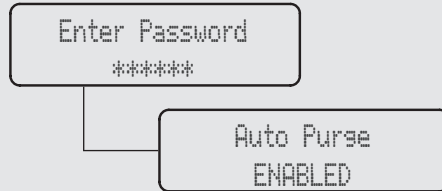

## “Technical” Programming

### Auto Purge

### Description

- This parameter allows the technician to enable or disable the auto clean function.
- If the autopurge function is enabled in the menu, hot water will be delivered by the group with a delay of 2 seconds form portafilter removal.



Display	Operating Procedure
<p>Enter Password *****</p>	<p>1 After accessing the “Technical” programming menu and entering the password, use the buttons T1  and T2  until the following screen is displayed.</p>
<p>Auto Purge DISABLED</p>	<p>2 Press the T3 button  to enter the menu, move between the parameters using the buttons T1  and T2  to select <b>ENABLED</b> or <b>DISABLED</b>, press the T3 button  to confirm the option.</p> <p>3 Press T1  or T2  to continue with the programming of the other parameters.</p>



### WARNING



THE COFFEE BOILER CONTAINS WATER AT ELEVATED TEMPERATURES.  
WATER TEMPERATURE OVER 52°C CAN CAUSE SEVERE BURNS INSTANTLY OR DEATH FROM SCALDING.

## “Technical” Programming





### Auto Purge

Enter Password  
\*\*\*\*\*

Auto Purge  
ENABLED

### Description

- This parameter allows the technician to enable or disable the auto clean function.
- If the autopurge function is enabled in the menu, hot water will be delivered by the group with a delay of 2 seconds form portafilter removal.

Display	Operating Procedure
<p>Exit Menu</p>	<p><b>4</b> To exit the menu move between the parameters using the buttons T1  and T2  until the exit menu is displayed. Press the T3 button  to exit the menu and return to the normal use of the espresso machine.</p>
<p>94.4      00:00 95.5   95.1   SB</p>	<p><b>5</b> Alternatively, you can exit the “Technical” programming and return to the normal use of the espresso machine by pressing T2  and T3  at the same time.</p>

**⚠ WARNING ⚠**

**THE COFFEE BOILER CONTAINS WATER AT ELEVATED TEMPERATURES.  
WATER TEMPERATURE OVER 52°C CAN CAUSE SEVERE BURNS INSTANTLY OR DEATH FROM SCALDING.**





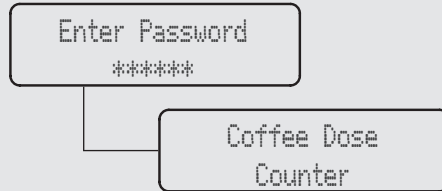

## “Technical” Programming

### Coffee Dose Counter

#### Description

- This parameter allows the technician to review the total doses dispensed for each button.
- This parameter displays different values:
  - Total coffee doses;
  - Coffee doses for each button;
  - Hot water doses.



Display	Operating Procedure
<div style="border: 1px solid black; padding: 5px; width: fit-content;">                     Enter Password *****                 </div>	<p><b>1</b> After accessing the “Technical” programming menu and entering the password, use the buttons T1  and T2  until the following screen is displayed.</p>
<div style="border: 1px solid black; padding: 5px; width: fit-content;">                     Coffee Dose Counter                 </div>	<p><b>2</b> Press the T3 button  to enter the menu.</p>
<div style="border: 1px solid black; padding: 5px; width: fit-content;">                     Total Coffee Doses: 63                 </div>	<p><b>3</b> Move between the parameters using the buttons T1  and T2  to display the desired option.</p>
<div style="border: 1px solid black; padding: 5px; width: fit-content;">                     Doses 61B1 10                 </div>	<p><b>4</b> Continuing to move with the buttons T1  and T2  you can display the total doses of each button.</p>

## “Technical” Programming

### Coffee Dose Counter

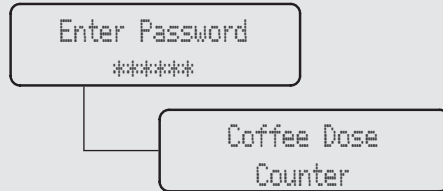

#### Description

- This parameter allows the technician to review the total doses dispensed for each button.
- This parameter displays different values:
  - Total coffee doses;
  - Coffee doses for each button;
  - Hot water doses.

Display	Operating Procedure
	<b>5</b> Continuing to move with the buttons T1  and T2  you can display the total doses of each button.
	<b>6</b> Continuing to move with the buttons T1  and T2  you can display the total doses of each button.
	<b>7</b> Continuing to move with the buttons T1  and T2  you can also display the total doses of the hot water button.
	<b>8</b> To exit the submenu move between the parameters using the buttons T1  and T2  until the exit submenu is displayed. Press the T3 button  to exit the submenu.







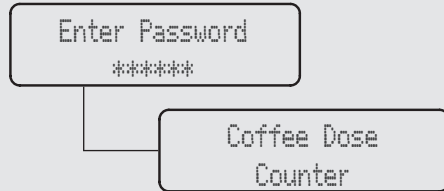



## “Technical” Programming

### Coffee Dose Counter

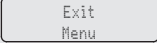

#### Description

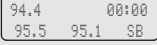
- This parameter allows the technician to review the total doses dispensed for each button.
- This parameter displays different values:
  - Total coffee doses;
  - Coffee doses for each button;
  - Hot water doses.

Display	Operating Procedure
	<p><b>9</b> Press T1  or T2  to continue with the programming of the other parameters.</p>
	<p><b>10</b> To exit the menu move between the parameters using the buttons T1  and T2  until the exit menu is displayed. Press the T3 button  to exit the menu and return to the normal use of the espresso machine.</p>
	<p><b>11</b> Alternatively, you can exit the “Technical” programming and return to the normal use of the espresso machine by pressing T2  and T3  at the same time.</p>





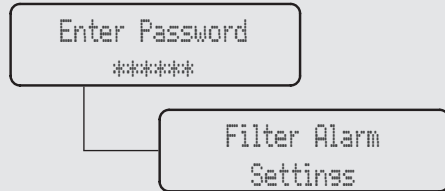





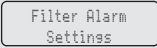

## “Technical” Programming

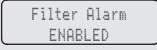
### Filter Alarm

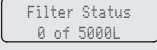

### Description

- This parameter enables the technician to program an alarm that will alert the user about the need for maintenance or replacement of the water filter.
- Once the set volume has been reached, the error message “Filter Alarm” will be displayed.
- A value of 0 (zero) disables the filter alarm parameter.
- This feature can be enabled or disabled.

Display	Operating Procedure
	<b>1</b> After accessing the “Technical” programming menu and entering the password, use the buttons T1  and T2  until the following screen is displayed.
	<b>2</b> Press the T3 button  to enter the menu.
	<b>3</b> Press the T3 button  to enter the menu, move between the parameters using the buttons T1  and T2  to select <b>ENABLED</b> or <b>DISABLED</b> , press the T3 button  to confirm the option.
	<b>4</b> Press the T3 button  to enter the menu, move between the parameters with the buttons T1  and T2  to set the desired value, press the T3 button  to confirm the value.













### Filter Alarm

Enter Password  
\*\*\*\*\*

Filter Alarm  
Settings

### Description

- This parameter enables the technician to program an alarm that will alert the user about the need for maintenance or replacement of the water filter.
- Once the set volume has been reached, the error message “Filter Alarm” will be displayed.
- A value of 0 (zero) disables the filter alarm parameter.
- This feature can be enabled or disabled.

Display	Operating Procedure
<p>Alarm Water Use 40 Coffee Water</p>	<p><b>5</b> Press the T3 button  to enter the menu, move between the parameters with the buttons T1  and T2  to set the desired value, press the T3 button  to confirm the value.</p>
<p>Filter Alarm Reset (0 L)</p>	<p><b>6</b> Press the T3 button  to enter the menu, move between the parameters with the buttons T1  and T2  to set the desired value, press the T3 button  to confirm the value.</p>
<p>Filter Alarm Exit</p>	<p><b>7</b> To exit the submenu move between the parameters using the buttons T1  and T2  until the exit submenu is displayed. Press the T3 button  to exit the submenu.</p> <p><b>8</b> Press T1  or T2  to continue with the programming of the other parameters.</p>



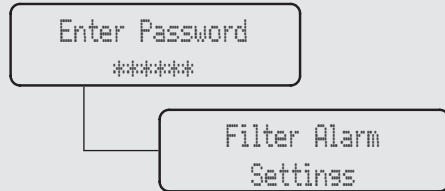

## “Technical” Programming

### Filter Alarm



### Description

- This parameter enables the technician to program an alarm that will alert the user about the need for maintenance or replacement of the water filter.
- Once the set volume has been reached, the error message “Filter Alarm” will be displayed.
- A value of 0 (zero) disables the filter alarm parameter.
- This feature can be enabled or disabled.

Display	Operating Procedure
<div data-bbox="176 668 333 714" style="border: 1px solid black; padding: 2px; text-align: center;">Exit Menu</div>	<p><b>9</b> To exit the menu move between the parameters using the buttons T1  and T2  until the exit menu is displayed. Press the T3 button  to exit the menu and return to the normal use of the espresso machine.</p>
<div data-bbox="176 800 333 846" style="border: 1px solid black; padding: 2px;">           94.4      00:00            95.5   95.1   SB         </div>	<p><b>10</b> Alternatively, you can exit the “Technical” programming and return to the normal use of the espresso machine by pressing T2  and T3  at the same time.</p>



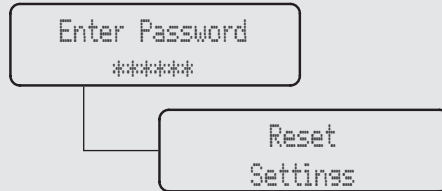

## “Technical” Programming

### Reset



### Description

- This parameter allows the technician to reset all the values returning to initial factory settings.
- It is possible to reset the settings you made in the “Barista” programming or the settings you made in the “Technical” programming.

Display	Operating Procedure
Enter Password *****	<b>1</b> After accessing the “Technical” programming menu and entering the password, use the buttons T1  and T2  until the following screen is displayed.
Reset Settings	<b>2</b> Press the T3 button  to enter the menu.
Barista Settings Reset	<b>3</b> Press the T3 button  to reset the settings you made in the “Barista” programming.
Tech. Settings Reset	<b>4</b> Press the T3 button  to reset the settings you made in the “Technical” programming.

## “Technical” Programming

### Reset

### Description

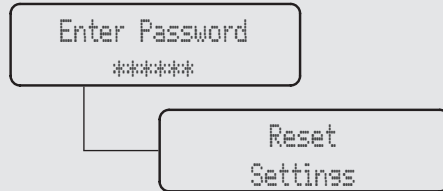

- This parameter allows the technician to reset all the values returning to initial factory settings.
- It is possible to reset the settings you made in the “Barista” programming or the settings you made in the “Technical” programming.





Display	Operating Procedure
	<p><b>5</b> To exit the submenu move between the parameters using the buttons T1  and T2  until the exit submenu is displayed. Press the T3 button  to exit the submenu.</p>
	<p><b>6</b> Press T1  or T2  to continue with the programming of the other parameters.</p>
	<p><b>7</b> To exit the menu move between the parameters using the buttons T1  and T2  until the exit menu is displayed. Press the T3 button  to exit the menu and return to the normal use of the espresso machine.</p>
	<p><b>8</b> Alternatively, you can exit the “Technical” programming and return to the normal use of the espresso machine by pressing T2  and T3  at the same time.</p>

### Update Firmware

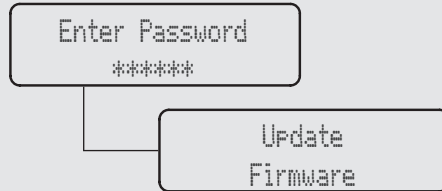
#### Description

- This parameter allows the technician to update the control unit of the espresso machine via a USB Pendrive.



Display	Operating Procedure
Enter Password *****	<b>1</b> After accessing the “Technical” programming menu and entering the password, use the buttons T1  and T2  until the following screen is displayed.
Update Firmware	<b>2</b> Press the T3 button  to update the firmware. The following screen will immediately appear.
Insert USB Key And Press Enter	<b>3</b> Insert the USB Pendrive into the USB port and press the T3 button  .
OFF      00:00	<b>4</b> When the update is over, the espresso machine restarts. Set the switch to 0 (zero) and then again to 1.

## “Technical” Programming

### Exit Menu

Enter Password  
\*\*\*\*\*

Exit  
Menu

### Description

- This parameter allows the technician to exit the “Technical” programming and return to the normal use of the espresso machine.

Display	Operating Procedure
<p data-bbox="176 668 331 711">Exit Menu</p>	<p data-bbox="366 668 1538 711"><b>1</b> Press the T3 button  to exit the “Technical” programming and return to the normal use of the espresso machine.</p>



## Troubleshooting

- This espresso machine is equipped with several feedback mechanisms that alert the operator when an unusual condition occurs. Additionally the espresso machine will warn the operator when certain parameters fall below or above the programmed point. These errors and warnings will appear as a message in the display.
- The following section will describe errors and warnings that may appear in the display.

Message	Description	Message Solution
Steam Boiler Autofill Failed	This message is displayed when the CPU does not detect a full signal from the steam boiler within the set time interval.	When this message is displayed the CPU also shuts down and turns off power to the machine (see the parameter "Level Timeout"). Press the ON/OFF button to reset this error.
Coffee Boiler 1 Probe Failed	This message is displayed when the CPU does not detect the temperature probe.	When this message is displayed the CPU shuts down and turns off the machine. The way to reset this error is to verify and to reconnect the temperature probe.
SB Filled?	This message is displayed during first installation and when preset of settings is made.	Push enter if Steam Boiler is filled. Verify the presence of water looking the sight glass.
Groups Bled?	This message is displayed during first installation and when preset of settings is made.	Push enter if groups have been blend ie no air is present in groups.
Coffee Boiler 1 Is Not Heating	This message is displayed when the coffee boiler does not reach the minimum temperature with the programmed time interval.	See the parameter "Heating Timeout" for more information. The number on the display corresponds to the number of the faulty coffee boiler.
Coffee Boiler 1 Overheated	This message is displayed when the coffee boiler temperature exceeds the maximum allowed temperature.	When this message is displayed call an authorized service technician to repair this fault. The also CPU turns power off to the coffee boiler.
Steam Boiler Probe Failed	This message is displayed when the CPU does not detect the temperature probe.	When this message is displayed the CPU shuts down and turns off the machine. The way to reset this error is to verify and to reconnect the temperature probe.
Steam Boiler Overheated	This message is displayed when the steam boiler temperature exceeds the maximum allowed temperature.	When this message is displayed call an authorized service technician to repair this fault. The also CPU turns power off to the steam boiler.
Steam Boiler Is Not Heating	This message is displayed when the steam boiler does not reach the minimum temperature with the programmed time interval.	See the parameter "Heating Timeout" for more information.
SB Htr Broken! TURN OFF NOW	This message is displayed when the temperature of the coffee boiler neck resistance increases by 5°C over one minute, despite it being switched off.	When this message is displayed immediately switch off the machine and contact an authorised maintenance technician to have the failure repaired. When this alarm is notified, the LEDs on the cup heater and hot water buttons blink.
Steam Boiler Is Empty	This message is displayed when the steam boiler level probe has not detected the water level for at least 2 seconds.	When this message is displayed please contact an authorised maintenance technician to have the failure repaired. When this alarm is notified, the LEDs on the cup heater and hot water buttons blink.
CB1 Htr Broken! TURN OFF NOW	This message is displayed when the temperature of the coffee boiler neck resistance increases by 5°C over one minute, despite it being switched off.	When this message is displayed immediately switch off the machine and contact an authorised maintenance technician to have the failure repaired. When this alarm is notified, the LEDs on the cup heater and hot water buttons blink.

Message	Description	Message Solution
Flow Meter 1 No Pulse	This message is displayed when the CPU does not receive the appropriate signal from the flowmeter.	When the flowmeter alarm is displayed, push a button to turn off the alarm. This problem is a result of water not flowing through the flow meter. This can be caused by the coffee packed too tightly, a blockage in the tubes, a malfunctioning water pump, a faulty valve, or a damaged flowmeter. Call a service technician to fix this problem.
Autofill In Progress	This message is displayed when the steam boiler autofill cycle is activated and water is entering the steam boiler.	No action is required when this message is displayed. This message is only displayed to notify the operator of the active process.
Invalid Password	This message is displayed when password entered does not match the programmed password.	This error message will be displayed anytime an incorrect password is entered. The machine comes back to the previous state.
Provide for the replacement	This message is displayed when the filter alarm is on. All the buttons flash	When this message is displayed perform the required maintenance operations on the water filter or replace it. No action is required on the espresso machine.



