

# manual

linea

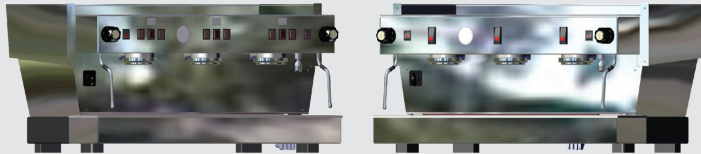

**la marzocco**

handmade in florence

# linea

Operating Manual V1.0 - 01/2022  
MAN.29.1

## Chapters

- |  |         |
|--|---------|
| 1. General Warnings and Safety Specifications    | page 3  |
| 2. Definition of Available Models                | page 8  |
| 3. Installation                                  | page 11 |
| 4. Appliance Operation and Coffee Preparation    | page 17 |
| 5. Dispensing Steam and Hot Water                | page 21 |
| 6. Maintenance and Periodic Cleaning Operations  | page 22 |
| 7. De-commissioning and Demolition               | page 25 |
| 8. Mandatory Maintenance and Check-up Operations | page 26 |
| 9. Software Programming Guide                    | page 28 |



## la marzocco

handmade in florence

La Marzocco S.r.l.

Via La Torre 14/H  
Località La Torre  
50038 Scarperia e San Piero  
(Firenze) - ITALY

[www.lamarzocco.com](http://www.lamarzocco.com)  
[info@lamarzocco.com](mailto:info@lamarzocco.com)

T: +39 055 849 191  
F: +39 055 849 1990

Original instructions verified by the manufacturer.



Scan QR Code to view the complete Software Programming Guide available on techcenter website.

Printed on recycled paper.

Available: certifications:



## 1. General Warnings and Safety Specifications

### WARNING

This appliance is for professional use only and should be installed in locations where its use and maintenance is restricted to trained personnel. Children are forbidden to operate or play with the appliance.

### WARNING

The appliance must be placed in a horizontal position on a counter higher than 80 cm from the ground.

### WARNING

This appliance is not suitable for outdoor use. Jets of water should not be used to clean the appliance, nor should it be placed where water jets are used.

### CAUTION

As already mentioned in the preceding notes, the manufacturer shall not be held responsible for damage to objects, animals and/or people whenever the appliance has not been installed according to the instructions contained in this manual, and is not used to do what it was designed for (i.e. preparing coffee and hot drinks).

#### 1) Important safeguards

- Appliance weighted sound pressure level is lower than 70 dBA.
- Use, cleaning and maintenance of this appliance can be carried out by people (including children more than 8

years of age) with reduced physical, sensory or mental capabilities, or lack of experience and knowledge, as long as they have been given supervision or instructions concerning its use by a person responsible for their safety and if they understand related dangers.

- Children should be supervised to ensure that they do not play with the appliance.
  - Keep the appliance and its cord out of the reach of children less than 8 years of age.
- 2) This operating manual is an integral and essential

part of the product and must be supplied to users. Users are asked to read the enclosed warnings and cautions carefully, as they provide valuable information concerning safety during installation, operation and maintenance. This manual must be kept in a safe place and be available for consultation to new and experienced users alike.

**3)** Ensure product's integrity by inspecting the packaging, making sure it presents no signs of damage which might have affected the enclosed appliance.

**4)** Check appliance integrity after having carefully removed the packaging.

**Note: In case of doubt, do not go**

**on any further and contact your dealer or retailer immediately. They will send out specialized personnel authorized to perform service on the appliance.**

**5)** Packaging (boxes, plastic bags, foam parts and whatever else) must not be left around within easy reach of children, due to the potential danger it represents, nor be discarded in the environment.

**6)** Check to see that data on the rating plate correspond to those of the main electrical supply which the appliance will be hooked up to.

**7)** The equipment must be installed to comply with applicable federal, state or local electrical and plumbing codes. Installation also must comply with manufacturer's

instructions, and must be performed by qualified and authorized personnel.

**8) Incorrect installation may cause injury/damages to people, animals or objects** for which the manufacturer shall not be held responsible.

**9)** Safe electrical operation of this device will be achieved only when connection to the power outlet has been completed correctly and in observance of all local, national, and international electrical codes and safety regulations, and particularly by grounding the unit. Make sure grounding has been done properly as it represents a fundamental safety requirement. Ensure qualified personnel check such connection.

**10)** Furthermore, you must ensure that the capacity of available electrical system is suitable for the maximum power consumption indicated on the appliance.

**11)** We do not recommend using adapters, multiple plugs and/or extension cords. If you cannot avoid using them, make sure that they are exclusively of the kind which conforms to local, national, and international electrical codes and safety regulations, thus being careful not to exceed power and current ratings indicated on such adapters and extension cords.

**12)** This device must be used exclusively for the functions it has been designed and built for. Any other application is

inappropriate and dangerous.

**The manufacturer shall not be held responsible for any damages caused by improper and/or irrational use.**

This appliance should not be installed in kitchens.

**13)** Using any electrical device requires that certain fundamental rules be observed. In particular:

- do not touch the appliance with wet or humid hands and feet;
- do not use the appliance while having no shoes on your feet;
- do not use extension cords in bath or shower rooms;
- do not unplug the appliance from power outlet by pulling on power supply cable;
- do not expose the appliance to atmospheric agents

(rain, sun, etc.);

- do not allow children or untrained people to use this appliance;
- do not clean control panel with a wet cloth since it is not watertight.

**14)** Before carrying out any maintenance and/or cleaning operations, turn the main switch, which is located on the front left of the appliance, to the “O” or “OFF” position, and disconnect the appliance from electrical network by unplugging the cord or by switching off the relevant circuit breaker. For any cleaning operation, follow exclusively the instructions included in this manual.

**15)** In case the appliance is operating in a faulty manner

or breaks down, disconnect it from electrical network (as described in the preceding point) and close water supply valve. Do not attempt to repair it. Contact a qualified and authorized professional to perform any repair. Repairs must be performed exclusively by the manufacturer or by an authorized centre using only original parts. Non-compliance with the above could compromise appliance safe operation.

**16)** During installation, you should plan to make use of an omnipolar connector, as required by local, national, and international electrical codes and regulations.

**17)** In order to avoid dangerous overheating problems, it is

recommended that the power supply cable be fully unfurled.

**18)** Do not obstruct air intake and exhaust grilles and, in particular, do not cover the cup warmer tray with cloths or other items.

**19)** Appliance power supply cable must not be replaced by users. In case power supply cable becomes damaged, shut off the appliance and disconnect it from the electrical network by switching off the relevant circuit breaker and close off the water supply; in order to replace the power supply cord, contact qualified professionals exclusively.

**20)** These instructions are also available in an alternative format on a website: <http://techcenter.lamarzocco.com>.

**21)** The appliance should be placed on a flat counter and in settings with the following temperatures:

- Minimum room temperature: 5°C/41°F;
- Maximum room temperature: 32°C/89°F.

**22)** Check your package to make sure that the following accessories are included:

- a number of 1-dose and 2-dose portafilters according to the number of groups;
- replacement 1-dose and 2-dose filter baskets
- 1 tamper
- 1 blind filter
- cleaning detergent, for the groups
- 3 stainless steel braided

hoses for water connections

- 1.5 m of reinforced plastic tubing for drainage
- 1 hose clamp

**23)** If the appliance has been temporarily housed in settings with a room temperature of less than 0°C/32°F, it must be placed in a warmer environment in order to allow hydraulic system gradual defrosting prior to use.

**24)** Water pressure supply must be between 0.2 and 0.6 MPa. The maximum inlet water pressure shall be at least 1.0 MPa (Denmark, Norway, Sweden, Finland).

**25)** This appliance is intended to be permanently connected to fixed wiring, and it is mandatory that a residual current device (RCD) with

a rated residual operating current not exceeding 30 mA is installed.

**26)** This appliance is designed only for preparing coffee and hot drinks.

**27)** Any modification to the equipment is prohibited; the manufacturer cannot be held liable for damage to property, animals, and/or persons if the equipment undergoes technical and aesthetic changes, changes in performance and characteristics, and in general is tampered with in one or more of its constituent components.

**COMMON DIMENSIONS AND WEIGHTS FOR THE LINEA SERIES**

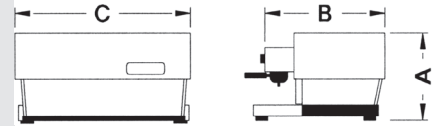

LINEA	1 group	2 groups	3 groups	4 groups
A cm/inch	44.4/17.5	44.4/17.5	44.4/17.5	44.4/17.5
B cm/inch	58.5/23	58.5/23	58.5/23	58.5/23
C cm/inch	49/20	69/28	93/37	117/46
WEIGHT [kg/lb]	41/90	59/130	73/164	107/236

## 2. Definition of available models

**This operating manual refers exclusively to the following models of our own manufacture:**

EE Model and AV Model with 1, 2, 3 and 4 groups

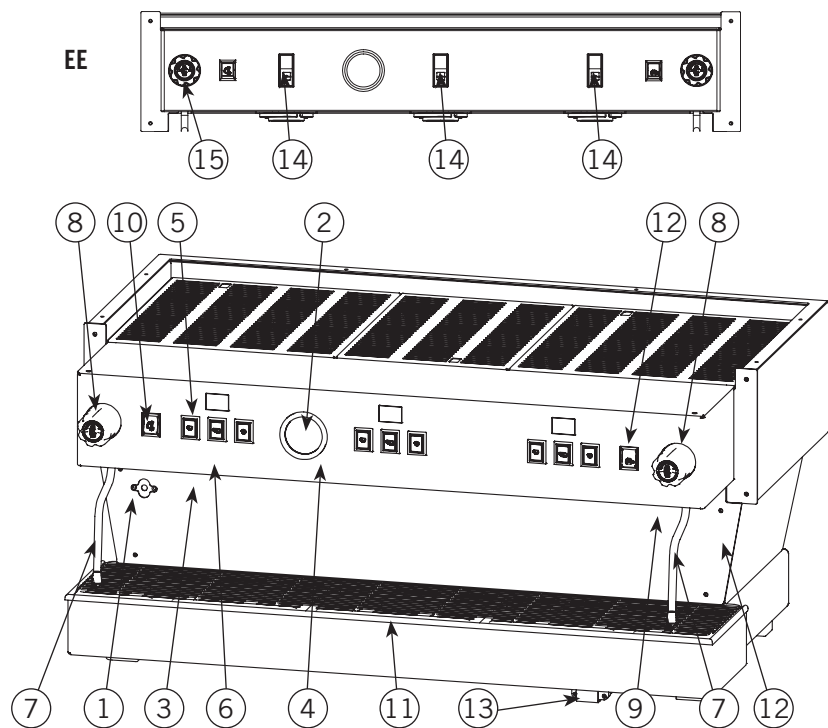

**Fig. 1 - Model AV & EE with 1, 2, 3 or 4 groups**

### Legend

- 1** Main Switch
- 2** Pressure Gauge (steam & coffee boiler)
- 3** Brew Groups
- 4** Control Panel
- 5** Group #1 Keypad
- 6** Digital Display
- 7** Steam Wand
- 8** Steam Knob
- 9** Hot Water Wand
- 10** Cup warmer switch (if present)
- 11** Removable Drain Tray
- 12** Hot Water Switch
- 13** Water sensor (if present)
- 14** Manual Brew Switch (EE model)
- 15** Hot Water Switch (EE model)

For additional information on electronics, keypads and software programming, please refer to “Software Programming your Espresso Machine” section.



## 1) General Description

The models AV and EE are built in 1, 2, 3 and 4 group versions and are essentially composed of the following parts:

1. Water boiler (produces steam and hot water);
2. Coffee ("saturation") boiler;
3. Brewing groups;
4. Exterior;
5. Water pump;

## 2) Description of the various parts

### • Steam Boiler

The steam boiler consists of a cylindrical tank, whose length varies according to coffee group number, which is made of stainless steel. Each unit is subjected to a hydraulic test, at a pressure of 3 bar, and has an operating pressure of 1.5 bar. You will find below a list of effective volumes and standard power ratings according to the number of groups installed:

1 group	3.5 litres	1300 Watts
2 groups	7 litres	3000 Watts
3 groups	11 litres	4000 Watts
4 groups	15 litres	4350 Watts

Higher powered heating elements are available for steam boilers in some markets. Covers are installed at either end of the cylindrical tank and on one of them there is a housing for water heating and

vapourizing electrical elements, which allow reaching operating pressure within approximately 25". Operating pressure is maintained by a pressure switch. The water boiler has various fittings used for safety devices, for supplying hot water and steam, and for power supply.

### • Coffee Boiler

The coffee boiler is subjected to a hydraulic test, at a pressure of 16 bar, and has an operating pressure of 9 bar. You will find below a list of effective volumes and power ratings according to the number of groups installed:

1 group	1.8 litres	1000 Watts
2 groups	3.4 litres	1400 Watts
3 groups	5.0 litres	1600 or 1900 Watts
4 groups	3.4 + 3.4 litres	1400 +1400 Watt (2 boilers installed)

It consists of a cylindrical tank, whose length varies according to coffee group number, which is made of stainless steel. Covers are installed at either end of the cylindrical tank and on one of them there is a housing for water heating and vapourizing electrical elements, regulated by a precision PID Controller, with a dT of  $\pm 0.5^{\circ}\text{C}$ , which keeps the water temperature constant. This temperature

can be adjusted to reach the optimal level according to the type of coffee blend being used. The groups are welded to the boiler.

### • Brewing Groups

The brew groups are made of stainless steel, where you are supposed to engage the portafilter used to hold the ground coffee; the espresso flows from the group, through a spout, into the cup(s) after the brewing button has been pressed.

### • Exterior cover

The exterior cover consists of painted and stainless sheet steel panels in order to provide good aesthetics, optimize ergonomics for the operator and reduce the chance of damage to a minimum.

### • Water Pump

A rotary vane pump is installed on water supply tubing and set up to operate anytime the coffee groups are activated and - through an autofill system - whenever the water boiler needs to be replenished.

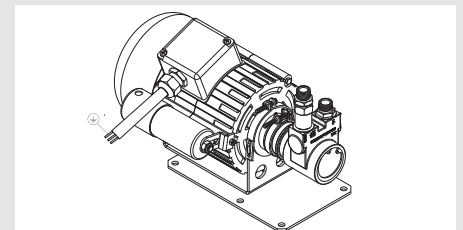

• **Water Sensor (if present)**

The probe that analyses the water entering the appliance (AQUATOP) performs a very precise TDS and total hardness reading. However, if a water softener with salt regeneration (Na + ion cationic resins) is installed upstream from the appliance, this reading will not be as reliable and precise.

In this case, we recommend you to consult your local technician for questions regarding water treatment.

• **FCC certification (USA and CANADA only)**

This coffee machine is equipped with a special radio module meeting FCC and ISED certification requirements.

FCC ID: 2AC7Z-ESPWROVERE  
IC ID: 21098-ESPWROVERE

• **Appliance CE plate:**

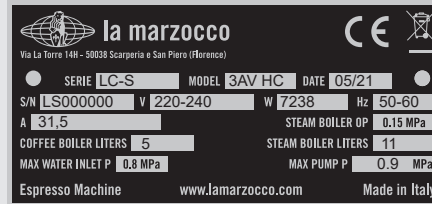

• **Appliance ETL plate:**

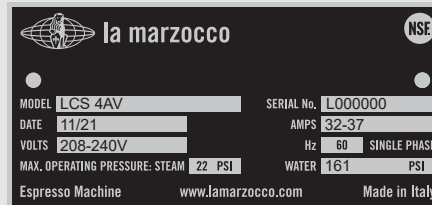

• **Appliance KC plate:**



### 3. Installation

MODEL/SERIES	GROUP	V/Hz	RATED POWER (W)	RATED INPUT (A)	COFFEE BOILER WATTAGE	STEAM BOILER WATTAGE	TOTAL WATTAGE	POWER CORD SIZE (mm <sup>2</sup> )	
LINEA	2GR	AC220-240V/60Hz	5445	23,7	1400	3000	5445	SEE ELECTRICAL CONNECTIONS FOR DETAILS	
		AC208-240/60Hz AC380/50Hz		20-23 10,7					
	3GR	AC220-240V/60Hz	7238	31,5	1900	4000	7238		
		AC208-240/60Hz AC380/50Hz		27-31 14,4					
	4GR	AC220-240V/60Hz	8763	8763	38	2800	4350		8763
		AC208-240/60Hz AC380/50Hz			32-37 16				

POWER CORD:	
3 X WIRES 220V 1 X BLUE (NEUTRAL) 1 X BROWN (PHASE) 1 X YELLOW & GREEN (GROUND)	5 X WIRES 380V 1 X BROWN (PHASE) 1 X BLUE (NEUTRAL) 1 X GRAY (PHASE) 1 X YELLOW & GREEN (GROUND) 4 X WIRES 220V 1 X BLACK (PHASE)

(ONLY FOR ETL) POWER CORD:

ONLY FOR 1 GROUP: NEMA 6-20	ONLY FOR 2 GROUPS: NEMA 6-30P	ONLY FOR 3 AND 4 GROUPS: NEMA 6-50P

**WARNING**

The appliance is intended to be permanently connected to fixed wiring, and it is mandatory that a residual current device (RCD) with a rated residual operating current not exceeding 30mA is installed.

**WARNING**

Coffee Boiler and Steam Boiler contain water at elevated temperature. Water temperature over 125°F / 52°C can cause severe burns instantly or death from scalding (Coffee Boiler 207°F/97°C - Steam Boiler 256°F / 124°C).

**WARNING**

Replace fuses with ones of the same size, type and rating. e.g. F1 = 2A, 250V.

**WARNING**

At each installation, the appliance should be equipped with a new set of tubes for plumbing and related gaskets.

**WARNING**

Water pressure supply must be between 0.2 and 0.6 MPa. If sufficient pressure is not available, we suggest the use of an additional water supply system.

**WARNING**

Before making any electrical connections make sure that the two strain relief connectors are firmly secured to appliance body in order to prevent inadvertent stress on power cables.

**WARNING**

This appliance should not be installed in kitchens.

**WARNING**

Hazardous voltage - disconnect from power supply before servicing.

**WARNING**

The motor pump must be placed close to the appliance in an accessible place for maintenance, but excluding any accidental interference, and where there is an optimal air circulation.

**WARNING**

The manufacturer declines any responsibility for any event leading to liability suits whenever grounding has not been completed according to current local, national, and international regulations and electrical codes, or other electrical parts have been connected improperly.

**WARNING**

This appliance is not intended for use by people (including children) with reduced physical, sensory or mental capabilities, or with lack of experience and knowledge, unless they have been given supervision or instructions concerning the use of the appliance by a person responsible for their safety.

**WARNING**

- USA and CANADA only - Do not connect to a circuit operating at more than 150V to ground on each leg.

**WARNING**

This appliance is not suitable for outdoor use. Jets of water should not be used to clean the appliance, nor should it be placed where water jets are used.

**▲ WARNING ▲**

**In order to prevent cracks or leakage: do not store or install the appliance in places where boiler or hydraulic system water might freeze.**

**Note:**

- Drinking water mains valve and electrical system circuit breakers should be located in the most convenient position for enabling the operator to access them easily and quickly.
- This appliance complies with 61000-3-11 standard and impedance at the supply interface must be  $Z_{max} = 0.104 \Omega$ .

**1) Power Switch Function**

The two-position power switch on the coffee machine front panel has two separate functions: ON and OFF.

**0 - OFF:** In this position, the coffee machine is disabled.

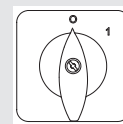

**Water specifications table**

		<b>Min.</b>	<b>Max.</b>
T.D.S. (Total Dissolved Solids)	ppm	90	150
Total Hardness	ppm	70	100
Total Iron (Fe <sup>+2</sup> /Fe <sup>+3</sup> )	ppm	0	0.02
Free Chlorine (Cl <sub>2</sub> )	ppm	0	0.05
Total Chlorine (Cl <sub>2</sub> )	ppm	0	0.1
pH	value	6.5	8.5
Alkalinity	ppm	40	80
Chloride (Cl <sup>-</sup> )	ppm	not more than	30

**I - ON:** In this position, the coffee machine is in operating mode. Power is applied to heating elements and all functions operate normally.

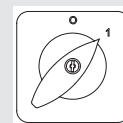

**N.B.:** Test water quality (appliance warranty will be void if water parameters are not within the range specified in the section “Installation”).

## 2) Installation on the counter

The image below shows the recommended method for drilling the hole on the counter.

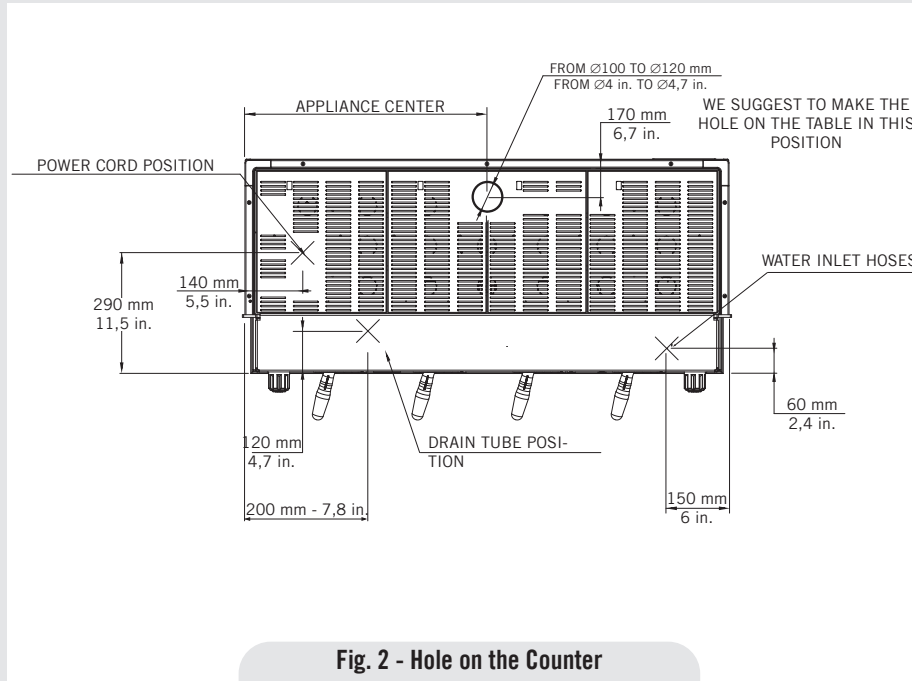

## 3) Accessories

In order to proceed with installation, it is necessary that the following are available:

- Pipes carrying drinking water with a 3/8" G (BSP) end connection; (3/8" Compression for USA and Canada)
- Electrical Supply according to the specification of the espresso machine purchased:
- Single/Three phase 220VAC - 50/60 Hz electrical connection with ground, protected socket and approved interlock switch
- Single phase 200VAC - 50/60 Hz electrical connection with ground, protected socket and approved interlock switch
- Three-phase, 380VAC - 50 Hz electrical connection with neutral + ground, near the bench on which the appliance is installed and terminating in a suitable protected five-pole socket equipped with an approved interlock switch
- Waste water drain system.

## 4) Water test kit

In order to enable you to check if your water supply is within the suggested ranges, all La Marzocco appliances will be equipped with two quick water test kits (see the image below) including 6 test-strips and instruction cards.

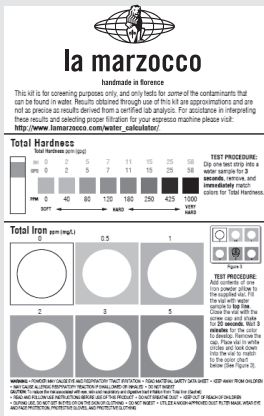

The parameters that you can measure are Total Hardness, Total Iron, Free Chlorine, Total Chlorine, pH & Total Alkalinity, Chlorides.

Ideally, you should perform a test on the water BEFORE the water treatment system and again AFTER the water system in order to verify if this is actually matching our suggested ranges.

Once the test has been performed, learn which treatment system is the most appropriate for your particular water supply by filling out the online water calculator on our website: LA MARZOCCO WATER CALCULATOR ([http://www.lamarzocco.com/water\\_calculator/](http://www.lamarzocco.com/water_calculator/)).

### 5) Water supply connection

In order to connect the appliance up to water

mains proceed according to the indications given in the chapter about Installation and in compliance with any local/national safety standards of the location in which the appliance is being installed. Equipment is to be installed with an adequate backflow protection to comply with applicable federal, state, and local codes.

In order to guarantee appliance correct and safe operation and to maintain an adequate performance level and a high quality of the beverages being brewed, it is important that the incoming water be of a hardness greater than 7°f (70ppm, 4°d) and less than 10°f (100ppm, 6°d), whereas pH should be between 6.5 and 8.5 and the quantity of chlorides be less than 30mg/l. Respecting these values allows the appliance to operate at maximum efficiency. If these parameters are not kept, a specific filtration device should be installed, while always adhering to the local national standards in place regarding potable water.

Then connect the inlet of the water filter/softener (if present) to drinking water supply using one of the supplied stainless steel braided hoses. Before connecting the filter to water pump, flush water supply line and the filtration system in order to eliminate any residual particles which could otherwise get stuck in taps or valves, thus preventing them from working

properly. Connect appliance water supply connection to water pump outlet using one of supplied stainless steel braided hoses. Then connect water pump inlet to water filter/softener outlet (if present).

**Note:** The water pump is a differential pressure volumetric pump and has been designed to be used exclusively with cold water. Make sure that water is always present while the pump is operating, otherwise air can be brought into brew boiler causing an undesirable condition and the pump can be damaged.

### 6) Electrical connections

#### a) Power supply cord

- This is the main power supply cable providing power to the whole appliance. There are different types of cables based upon the electrical requirements of the espresso machine purchased:
  - 200/220VAC 1-Phase, 3-core cable with 4/6/10mm<sup>2</sup> cross section or AWG 12/10/8 for 2,3 4 group versions, secured to espresso machine via a strain relief connector
  - 220VAC 3-Phase, 4-core cable with 4 mm<sup>2</sup> cross section for 2, 3 and 4 group versions, secured to espresso machine via a strain relief connector
  - 380 VAC 3-Phase, 5-core cable with 2.5mm<sup>2</sup> cross section for 2, 3 and 4 group versions, secured to espresso machine via a strain relief connector.

### b) Water pump motor power cord

This is the power supply for water pump motor. The internal electronics will switch the pump motor on when needed.

- 3-core cable with 1.5 mm<sup>2</sup> cross section or 3-core AWG 16 (for UL version) secured to espresso machine via a strain relief connector.

### c) Quick connection between water pump and espresso coffee machine.

The electrical connection must be made by using the connectors, as shown in the following figures:

- View of the connectors;

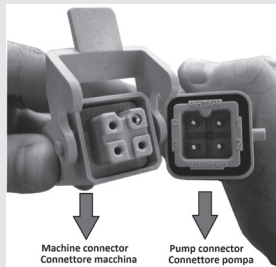

Appliance connector Pump connector

- Cable connection;

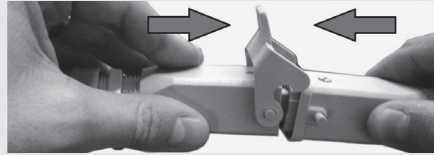

- Cable tightening;

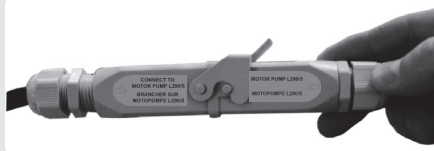

### 7) Waste water drain connection

Espresso machine drain is to be connected by means of included reinforced plastic tubing. Connect one end of the reinforced plastic tubing to drain hose connection on the left side of the espresso machine, secure with included hose clamp. Connect the other end to a suitable waste water collection system.

In case such a system is not available, drained liquids may be collected in a suitable bucket, and any necessary drain pipe extensions shall be made using steel-lined PVC tubing and suitable hose clamps.



## 4. Appliance Operation and Coffee Preparation

### CAUTION

Never remove the filter holder when water is being delivered. This operation can be extremely dangerous since the high pressure built-up inside the blind filter would spray out hot and slightly caustic water, which may cause severe burns. Coffee Boiler contains water at elevated temperature. Water temperature over 125°F / 52°C can cause severe burns instantly or death from scalding.

### WARNING

The appliance must not be dipped in, nor splashed with, water in order to clean it. For cleaning operations, please follow the instructions listed below very carefully.

### WARNING

This appliance is designed only for preparing coffee and hot drinks.

### IMPORTANT

To improve the flavour of the espresso, the temperature of the water in the coffee boiler and therefore of the groups may eventually be raised or lowered via the digital display (please refer to Software Programming Manual for detailed instructions).

Once installation has been completed, you can proceed to hook up the filter holders called “portafilters”, together with their filters, to the bottom of the groups by rotating them from left to right. Before operating the various switches and thus powering up heater elements, fill up the boiler tanks with water, as follows:

#### 1. COFFEE BOILER

Water flows into coffee boiler directly, as soon as the water system and purifier taps are opened. Since inflowing water will compress the air in the boiler, it will be necessary, in order to completely “saturate” the boiler-groups assembly, to remove group cover plate and to slightly unscrew the small bolts called “bleed screws” so as to allow air to escape until

a few drops of water leak out (see the diagram below). This should be repeated for each group, then tighten the bleed screws again and reinstall the cover.

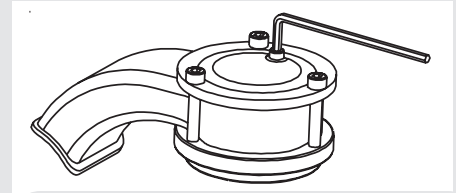

Saturation of group via “bleed screws”

#### 2) STEAM BOILER

Automatic fill system is switched on by turning the main switch to position “1”, so that the steam boiler, through solenoid valve and motor pump activation, will be filled up to a preset level, which can be selected by adjusting the probe inside the boiler itself.

#### N.B.

It may happen that the air inside the boiler builds up a certain pressure level (which can be detected through the pressure gauge). In order to deal with this issue, turn the appliance off and bleed the air from the groups (see the previous page for instructions).

Once you have completed these operations, turn the main switch to position “2” and wait for the boilers to reach operating temperature and pressure (which takes

from 20 to 35 minutes, depending on appliance size): the relevant values will be automatically kept at a constant level from now on.

During this time, the pointer of the lower scale on the pressure gauge may reach as high as 11-12 bar; this may occur any time that, while activating groups, motor pump forces cold water into coffee boiler at a pressure of 8-9 bar and, simultaneously, the temperature controller regulating the temperature of the boiler itself switches on the heating elements in order to bring the water contained in such boiler up to operating temperature. However, in this case it is necessary to adjust the expansion valve in such a way that the pressure will never exceed the value of 12 bar.

### **Brewing after first installation**

Once the first installation procedures are completed, please follow the steps below before proceeding with brewing coffee, hot water and steam:

- Engage the portafilters by inserting them into groups, brew water through each of them for at least two minutes.
- Being careful to avoid burns, turn on each steam wand for at least one minute.
- Turn on hot water valve for the time necessary to allow the following quantities of water to be brewed:
  - At least 1 liter for a 1-2 group machine
  - At least 2 liters for a 3 group machine
  - At least 3 liters for a 4 group machine



#### **For EE model**

Take a portafilter and place some ground coffee in the filter itself: the suggested amounts (in grams) to be used are laser-marked on the actual filters. Press down on the ground coffee with the supplied tamper, engage the filter holder in the group and then press the switch, thus allowing coffee to be brewed; when you have obtained your desired amount of coffee, press the switch again so that the machine can discharge the pressure built up in the filter holder. The holder may then be removed to proceed with making another coffee, as required.

#### **For AV model**

It is essential to program the quantity of water delivered by performing the following operations with the utmost care. In case of doubt or difficulties, please contact our technical service.

#### **Introduction**

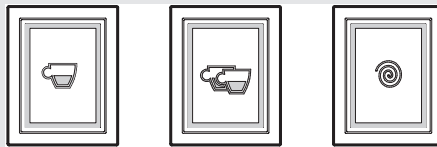

**COFFEE BREWING CONTROL PANEL**

The coffee metering system is based on the amount of water which will be delivered onto the ground coffee already placed in the filter and the portafilter, which is measured through a water volume control system (located above the group assembly flange, where the group connects to the boiler). Inside each counter there is a paddle wheel (which we shall call “the wheel” for simplicity’s sake) which rotates as water flows by.

Water cycle sequence is as follows:

- |                |   |                      |
|----------------|---|----------------------|
| group          | → | counter              |
| counter        | → | solenoid valve       |
| solenoid valve | → | diffuser             |
| diffuser       | → | coffee brewing spout |

The wheel is designed in such a way as to rotate freely when water is flowing by; it sends 2 signals, at each complete rotation, to the electronic module which processes them and activates solenoid valve relay of the corresponding group, as well as motor pump relay.

Such electronic module also processes the signal sent by boiler’s level gauge and consequently activates the relevant solenoid valve relay of the same motor pump.

#### **Dose programming procedure**

Press and hold the button with the spiral symbol for more than 5 seconds. You can then follow the same operations as for the standard version, which are described in the following.

LEDs stay on for 5 seconds after which,



if no button has been pressed, they turn off; you must then repeat the above-mentioned procedure to turn them on again and to prepare the electronic module for programming;

1. press the first button within 5 seconds and press it again once you have obtained the desired amount of coffee; at this point, LEDs will turn off and this button remains programmed as for the dose brewed previously;

2. repeat these steps for the other three buttons; any time a button has been programmed, by pressing the button with the spiral again, the LED of the programmed button(s) will remain switched off.

3. once you have programmed the first 2 buttons of the first control panel from the left, the dosage programs set according to the above will be stored in the memory and the 3rd button (the one with the spiral) will return to its function as a continuous brewing on/off button.

#### **N.B.**

Programs for the first group from the left will become the default programs for the remaining groups (unless you wish to program these groups differently, in which

case you will need to follow steps 1 to 5 for remaining control panels). The leftmost control panel must be programmed first; indeed, if you are going to program this last, all its settings will be automatically transferred to the other groups.

It is recommended that each group be programmed separately, from left to right. Each button also works as a switch and, therefore, you may stop coffee brewing at any time, whenever you have obtained the desired quantity, by pressing the same button.

#### **Fault warnings**

If the wheel does not send any signals to the electronic module for more than 3-4 seconds, the LED of the button which has been pressed will start flashing.

This means that:

A) water is not flowing over the wheel and therefore is not reaching the coffee groups, which may be due to:

1. the ground coffee being too fine, i.e. coffee gets brewed too slowly (drop by drop) and therefore the wheel cannot measure the water flow within electronic module factory-set time.

2. insufficient water flow through the groups (i.e. onto the coffee powder), probably caused by a combination of one or more of the following factors:

- partial blockage in one of the pipes;
- a malfunctioning motor pump;
- a malfunctioning solenoid valve;
- partial blockage of the diffuser screen.

B) there are calcium deposits inside water flow counter which prevent the wheel from turning properly.

C) the wheel itself and the sensor (top part) of the counter may be faulty.

#### **Coffee brewing**

Take a portafilter and place some ground coffee in the filter itself: 1 dose for the small filter, 2 doses for the larger filter.

Press down on the ground coffee with the supplied tamper and engage the filter holder again into the bottom of the group, then press one of the buttons with the symbols for 1 or 2 cups.

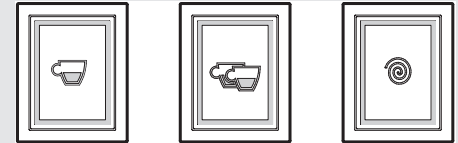

You can also press the same button again in order to terminate coffee brewing before its programmed stop. Should you need an unusual amount of coffee, you will be able to use the button with the spiral symbol and press it again once you have obtained the desired quantity.



Once the coffee has been completely brewed, pressure in the filter holder is automatically discharged and the portafilter can then be removed to repeat the operation as needed.

#### **GENERAL NOTIONS FOR PREPARING COFFEE**

Once the machine has reached both of its operating pressure (1.2 to 1.5 bar) - which can be checked by looking at the upper scale in the pressure gauge - and its operating temperature, with the body/group already at infusion temperature, filter holder and filter must be heated even more since they are at the lowest position of the group itself, and they are partially isolated from the same due to the rubber gasket between them.

This operation can be carried out by activating the switches and keeping them in the brewing position for approx. 45 seconds, after which you must turn them off and wait for 2-3 more minutes.

During this time, the pointer of the lower scale of the pressure gauge may reach as

high as 11-12 bar; this may occur any time that, while activating the groups, the motor pump forces cold water into the coffee boiler at a pressure of 8-9 bar and, simultaneously, the software regulating the temperature of the boiler itself switches on heating elements in order to bring the water contained in such boiler up to operating temperature.

However, in this case it will be necessary to adjust the expansion valve in such a way that pressure never exceeds the value of 12 bar.

Both the size of coffee granules and the type of coffee mix used are extremely important for being able to prepare a good cup of coffee.

The ideal grind can be determined by making various coffees and putting the amount of ground coffee that you would normally use for each cup (we recommend at least 7 g): the best grind will be the one allowing coffee to flow out from filter holder spouts neither too slowly nor too quickly.

#### **IMPORTANT**

Water temperature in the coffee boiler and therefore in the groups can be raised or decreased by means of software programming, if necessary - see next chapter for further details.

The final adjustment of the same should be made during tuning-up, once the appliance has been permanently installed. The pressure of the water on the coffee during the brewing is very important: for this reason it is important to set the by-pass on the pump at 9 bar.

This value changes if there are variations on the incoming pressure from your local water system: should that be the case, make all necessary technical adjustments on the system in order to eliminate such variations.

## 5. Dispensing Steam and Hot Water

### 1) Steaming milk or other liquids

In order to allow for any condensed water in the wand to be released, ALWAYS let some steam be discharged by turning on the valve before inserting the steam wand into the pitcher of liquid to be heated.

Dip one of the 2 steam wands connected to steam valve (part 7, page 8), into the liquid to be heated, turn the steam knob gradually until steam comes out at the end of the wand.

Steam will transfer heat to the liquid raising its temperature up to boiling point. Be careful not to allow liquid to overflow in order to avoid severe burns.

In order to prevent the heated liquid from being sucked back into steam boiler it is recommended, before using the wand, to purge the steam valve and steam wand by opening the valve for a few seconds, thus allowing steam to escape to the atmosphere from steam wand end. Failure to do so can cause the heated liquid to move from the heated liquid container to the steam

boiler (via the vacuum created by cooling parts). This condition is undesirable and can cause steam boiler contamination. After use remember to purge the wand by opening the steam valve for a few seconds, and then clean the outside of the wand itself with an appropriate cloth.

In order to prepare milk for making cappuccino with the right amount of foam, go through the following steps:

- After purging the steam wand, place underneath the container half-full of milk, carefully open the steam valve and raise the container so as to bring the wand end to a point just below the surface of the milk; now move the container up and down just enough to dip the nozzle end in and out of the milk until you get the right amount of foam, bring the temperature of the milk almost up to 149/158°F or 65/70°C.

You can then pour this milk into a cup containing warm espresso, thus obtaining a fresh cup of cappuccino.

### 2) Preparing tea and other hot drinks.

You can dispense hot water by using the fixed nozzle (part 12, page 8).

To dispense hot water, press the hot water button. This button commands hot water delivery.

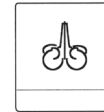

## 6. Maintenance and Periodic Cleaning Operations

### WARNING

If the above-mentioned instructions are not adhered to, the manufacturer cannot be held responsible for damage to people or things.

### WARNING

In order to prevent cracks or leakage: do not store or install the appliance in places where temperature might cause water in boiler or hydraulic system to freeze.

### WARNING

The appliance is intended to be permanently connected to fixed wiring, and it is advisable that a residual current device (RCD) with a rated residual operating current not exceeding 30mA is installed.

### WARNING

The appliance must be installed so that qualified technical personnel can easily access it for maintenance, if needed.

### WARNING

The appliance must not be dipped in, nor splashed with, water in order to clean it. For cleaning operations, please follow the instructions listed below very carefully.

### WARNING

Do not remove the filter holder while the relevant group is brewing hot liquids.  
The Coffee Boiler contains water at elevated temperature. Water temperature over 125°F / 52°C can cause severe burns instantly or death from scalding.

### WARNING

This appliance is for professional use only and should be installed in locations where its use and maintenance is restricted to trained personnel.

### WARNING

Jets of water should not be used to clean the appliance, nor should it be placed where water jets are used.

#### Cleaning groups and drain wells

Insert the blind filter into portafilter and put the correct amount of espresso cleaning product (following product's instructions) into the filter, engage the portafilter into the group you want to clean.

- Press the brewing button for said group, as if you were making a regular cup of coffee. Stop dispensing water after about 15-20 seconds.
- Start and stop the group several times until you notice clear water being released instead of soapy water when you remove the portafilter.

**Do not remove the portafilter when group is actually brewing water.**

- Rinse the group using a normal filter in the portafilter, by running hot water through it several times.

#### **Cleaning filters and filter holders**

For the daily cleaning of the stainless steel filters and portafilters it is sufficient to use water and a cloth or appropriate brush. Otherwise, use an espresso cleaning product according to the product's instructions, put a correct dose of the same in about 1/2 a litre of water inside a heat-resistant container and heat.

- When using stainless steel portafilters with snap-on spouts remove those spouts. Immerse filters and portafilter metallic parts (not handles) in a hot solution and leave them submerged for about 30 minutes.
- Rinse thoroughly with clean water and run hot water through the group several times with the filter and portafilter engaged.
- Make one cup of coffee in order to remove any unpleasant flavour.

#### **Cleaning the drain collector**

Remove the drain tray grill every night, pull out the water drain collector and clean it thoroughly.

Also, inspect and clean the drain well at

least twice a week and remove any leftover grounds with a tablespoon.

#### **Cleaning the body**

Wipe the stainless steel surfaces with a soft cloth in the direction of the glazing marks, if any.

Do not use any alcohol or solvents whatsoever on painted or imprinted parts in order not to damage them.

#### **Cleaning hot water and steam nozzles**

Steam nozzles must be cleaned immediately after use with a damp cloth and by producing a short burst of steam (being careful to avoid burns), so as to prevent the formation of deposits inside the nozzles themselves, which may alter the flavour of other drinks to be heated.

#### **Cleaning diffuser screens (infusion filter)**

Due to filter holder discharge operations (subsequent to coffee brewing), a certain amount of coffee grounds may slowly build-up on and obstruct, even partially, the infusion filter.

In order to clean, first remove them by unscrewing the retainer screw, then soak in espresso detergent powder.

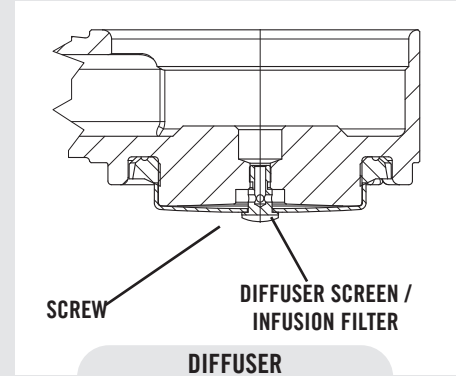

#### **Water Pump**

Motor pump is a positive-displacement one and can develop a pressure of 14 bar. Its operating pressure is 8-9 bar and this value is factory preset during testing; however, such pressure may vary from place to place since the pump pressure is affected by incoming water mains pressure.

You must always check the pressure itself by looking at the lower scale on the pressure gauge whenever you are brewing coffee, and you can increase such pressure, as required, by turning by-pass screw (below the plug located on the side to which the pump power supply is connected) clockwise, or reduce the pressure by turning said screw counter-clockwise.

Adjust pressure only when at least one group is brewing coffee.

## IMPORTANT

When you activate the motor pump by pressing the specific button, it turns out that pressure is also directly given to the coffee boiler.

If you activate the motor pump when the appliance is cold, a start-up pressure of 8-9 bar will develop; thus, once heating elements start working and water temperature increases, the liquid will expand increasing also start-up pressure by about 3 bar, for a total pressure of 11 bar.

Once operating pressure is reached, the expansion (safety) valve should start working by discharging a few drops of water, in order to prevent such pressure from exceeding the value of 12 bar.

If pressure exceeds 12 bar, you must adjust the valve by unscrewing the cap slightly. If this is not sufficient, remove the valve itself and clear away any calcium deposits. This remedy is valid if the valve remains open in drain position (i.e. pressure cannot increase up to approx. 8 bar) too.

If the appliance has not been used for more than 8 hours or, in any case, after long periods of being kept idle, in order to be able to use it to the relevant full potential it is necessary to perform some cleaning cycles before starting brewing beverages as follows:

- Groups: after having engaged the por-

tafilters, brew water through each of them for at least two minutes

- Being careful to avoid burns, turn on each steam wand for at least one minute.
- Turn on hot water valve for the time necessary to allow the following quantities of water to be brewed:

At least 1 liter for a 1-2 group machine

At least 2 liters for a 3 group machine

At least 3 liters for a 4 group machine

If the appliance is not going to be used for long periods of time, it is advisable to follow these safety indications:

- Disconnect the appliance from water mains or interrupt water connection via a mains tap.
- Disconnect the appliance from electrical mains.

### • Draining the steam boiler:

We recommend to fully drain the steam boiler YEARLY by means of the specific drain cock located on the side of the boiler or under it.

### • Depressurizing the steam boiler:

Press and hold the encoder knob to set the espresso machine to "OFF", then push down the steam lever in order to depressurize the steam boiler.



## 7. De-commissioning and Demolition

### 1) De-commissioning and demolition

First of all, set the main switch to “O” or OFF position.

#### **Disconnecting from power outlet:**

Disconnect the appliance from the electrical network by switching off the corresponding circuit breaker or circuit protection device.

Remove power supply cord from power connection.

Remove the pump motor power cord from water pump motor.

#### **Disconnecting from water system:**

Shut off the water supply by closing the specific tap located upstream from water filter/softener inlet.

Disconnect the water pipe at water filter/softener inlet.

Remove the hose connecting the espresso machine to water pump.

Remove the reinforced plastic tubing on drain connection.

At this point, the appliance may be removed from the bar, being very careful not to drop it or squash your fingers.

The appliance is made out of various materials and therefore, if you do not intend to put it back in service, it must be taken to a special disposal company that will select the materials which can be recycled and discard the others.

Current regulations make it illegal to discard such appliance by leaving it on public grounds or on any private property.

#### **Recycling notice: Warning for the protection of the environment.**

Used Electrical and electronic waste contains hazardous but also valuable and scarce materials which should be recovered and recycled properly. We kindly ask that you contribute to the protection of the environment and natural resources by delivering used equipment to the relevant recycling locations if such locations are available in your country.



## 8. Mandatory Maintenance and Check-up Operations

---

These operations are in addition to the Maintenance and Periodic Cleaning Operations as specified in Chapter 7.

The following maintenance and check-up operations should be carried out by a qualified technician.

**N.B. These periodic maintenance operations are not covered by warranty.**

### EVERY THREE/FOUR MONTHS

- Replace group gaskets
- Replace diffuser screens
- Clean auto-fill probe
- Check vacuum breaker for proper operation
- Inspect water inlet valve
- Inspect drain system for leaks or clogs
- Check flow rate for each group
- Check brew temperature (warranty is voided)
- Check that brew pressure is at 9 bar
- Check all switches for proper operation
- Check/note water hardness (Water quality must be within the range of the parameters specified in Installation chapter otherwise warranty is voided)

#### For AV Model:

- Check shot volumes
- Test flowmeter's ohm value (which will be acceptable if greater than 1.8 Kohm and less than 2.2 Kohm)

---

### EVERY SIX MONTHS (in addition to the above)

- Rebuild steam assemblies
- Replace autosteam gaskets (if present)

---

### EVERY YEAR (in addition to the above)

- Replace portafilter baskets
- Inspect group valve plungers
- Inspect vacuum breaker
- Inspect steam boiler pressure switch
- Inspect contactor
- Replace over-pressure valve
- Accurate control of tightness, which must be equal to 2.4 Nm for each cable on the terminal block.

---

### EVERY 2 YEARS (in addition to the above)

- Replace safety valve closure

---

### EVERY 3 YEARS (in addition to the above)

- Check the condition of the inside of boilers and, if necessary, rinse out with a proper cleaning product allowed for food and beverage appliances.



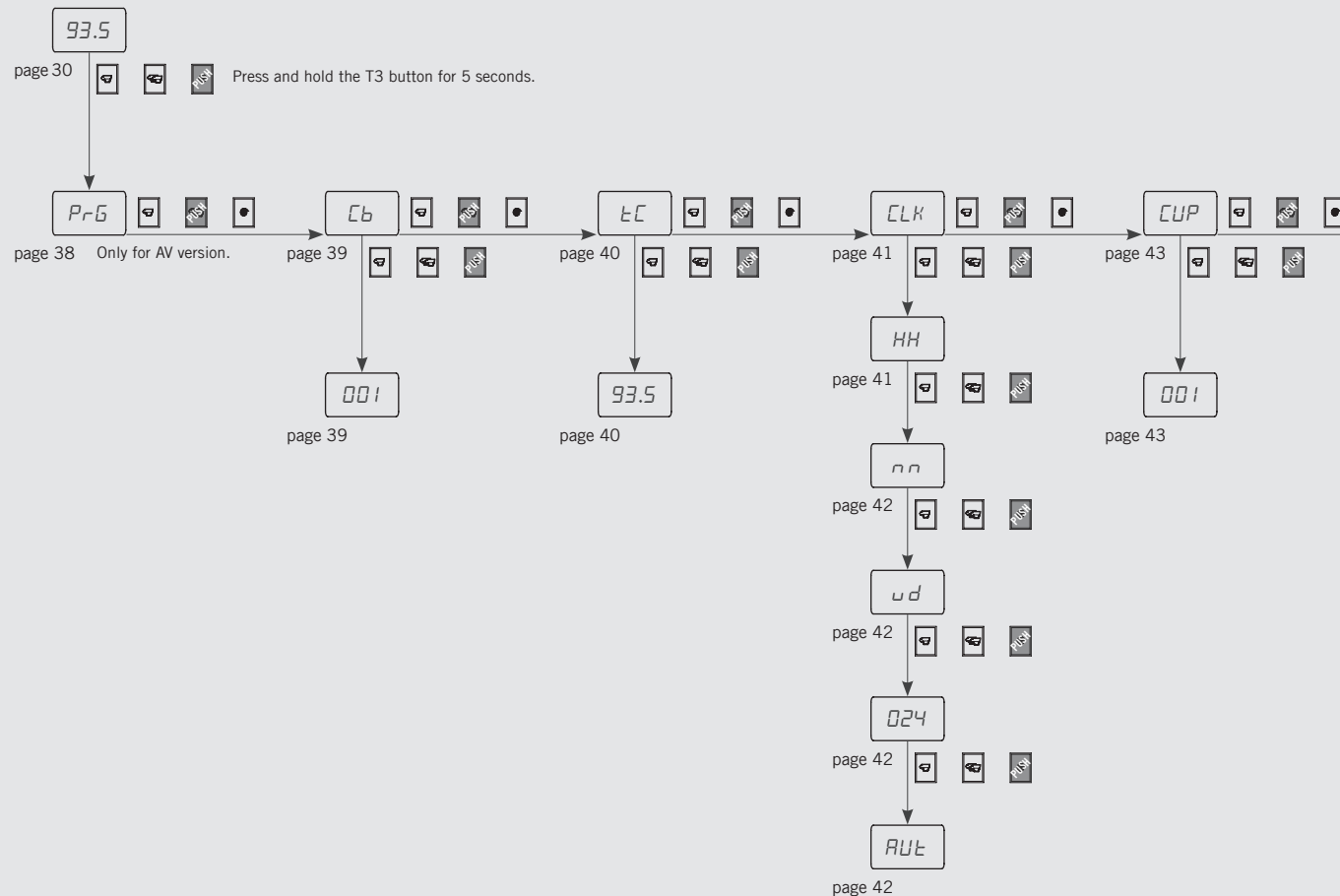

# “Barista” Programming

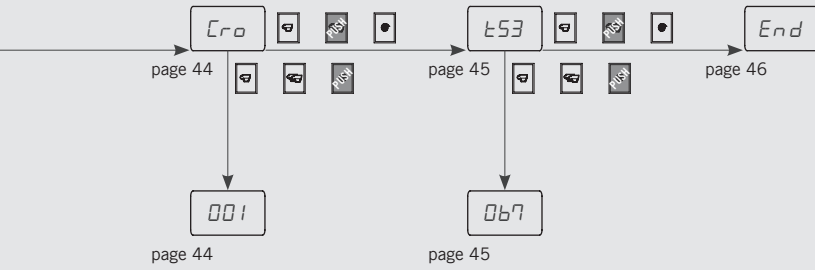

## Programming Introduction

---

### Description

- This espresso machine has a CPU and many configurable settings.
- Additionally, there are many feedback controls used in this espresso machine to troubleshoot problems, if any.
- The following is a brief introduction to the controls and display and how they interact with the operator.

## Digital Display

---

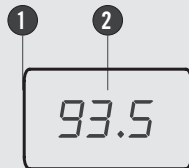

1 Digital display

2 Coffee boiler temperature

The digital display is a backlit display capable of displaying 3 digit 7 segments. The display enables the operator to interact with the espresso machine to visibly change parameter values. It also provides valuable information to the operator.

There are several warnings that can be displayed to alert the operator of an unusual condition or a fault.

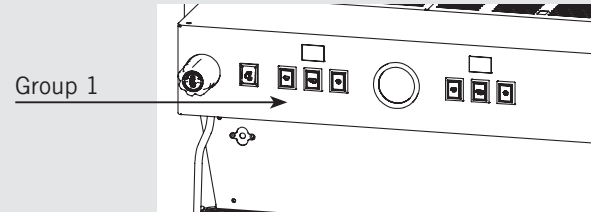
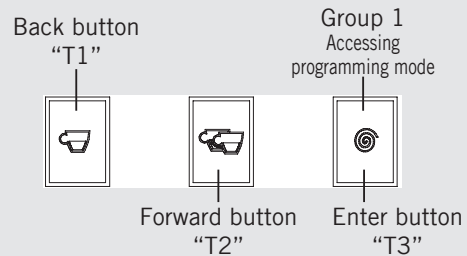

Additionally, simple messages are displayed alerting the operator that an action has been started or a process needs to begin.

## Programming AV Keypad



The keypad has two functions: the first one is for controlling the espresso, whereas the second one is for programming individual software parameters.



The programming of the individual parameters is possible only using the buttons in the group 1 (group starting from the left).

Button	Description
	<p>This button is used to control the brewing of a single espresso. It is also used for programming such individual parameters as the "back" button in the menu.</p> <p>For simplicity's sake in this manual it will be indicated with the name "T1".</p>
	<p>This button is used to control the brewing of a double espresso. It is also used for programming such individual parameters as the "forward" button in the menu.</p> <p>For simplicity's sake in this manual it will be indicated with the name "T2".</p>
	<p>This button is used for a continuous control of the brewing of the espresso. It is also used for programming such individual parameters as the "Enter" button in the menu.</p> <p>For simplicity's sake in this manual it will be indicated with the name "T3".</p>

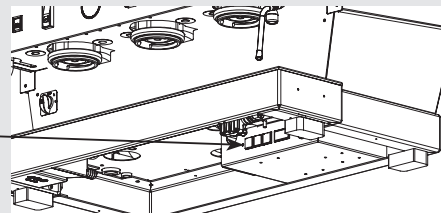
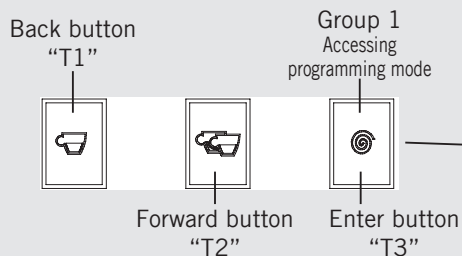
## Programming EE Keypad







The programming of individual parameters is possible only using these buttons.

Button	Description
	This button is used for programming such individual parameters as the "Back" button in the menu. For simplicity's sake in this manual it will be indicated with the name "T1".
	This button is used for programming such individual parameters as the "Forward" button in the menu. For simplicity's sake in this manual it will be indicated with the name "T2".
	This button is used for programming such individual parameters as the "Enter" button in the menu. For simplicity's sake in this manual it will be indicated with the name "T3".



## Programming Keypad

Button	Description
 + 	Press this button to activate the Backflush function.
 + 	Press this key combination to activate espresso machine OFF mode.

## First Use Procedure

### Turning the Espresso Machine On





#### Description

The following is the procedure to be followed for the first use of the espresso machine.

- Please follow this procedures carefully to avoid any damage to the espresso machine.

- First of all, check espresso machine water connection.
- Then make sure you have filled boilers.

Display	Operating Procedure
	<p><b>1</b> Turn the Main Switch to “1” position.</p>
	<p><b>2</b> When the machine is filled, to continue with the start up process, press the T2 button to activate the heating elements.</p> <p>When the set temperature is reached all button lights turn on: now the machine is ready for use.</p>
	<p><b>3</b> <b>NOTE:</b> Ensure all air is removed from the group prior to starting the espresso machine. This only needs to be completed once during the initial setup procedure or when water is drained from coffee boiler.</p> <p>Instructions for bleeding the groups of air can be found in the Installation Guide.</p>

**⚠ WARNING ⚠**

**HAZARDOUS VOLTAGE - DISCONNECT FROM POWER SUPPLY BEFORE SERVICING**

## Turning the Espresso Machine Off





### Description

The following is the procedure for turning off espresso machine power.

- Please follow this procedure carefully to avoid any damage to the espresso machine.

- This machine has two off settings: the first of them turns off all of the components in the espresso machine and the other one turns off power to the whole espresso machine.

Display	Operating Procedure
	<p><b>1</b> The following is the procedure for safely turning off the espresso machine.</p> <p><b>2</b> Press and hold the buttons T3 and T2 at the same time. Display will change to the following:</p>
	<p><b>3</b> This is the OFF setting used in normal operating conditions.</p> <p>During servicing or other conditions that warrant it, the main switch should be turned to the “0” position.</p>
	<p>The espresso machine is off and display should be blank.</p> <p><b>4</b> It is important to follow this procedure when turning off the machine. Failure to do so can damage the electronics.</p>

**⚠ WARNING ⚠**

**HAZARDOUS VOLTAGE - DISCONNECT FROM POWER SUPPLY BEFORE SERVICING**

## Accessing Programming Mode

### Programming Mode



### Description

- In order to change the values of any parameter the operator must first enter into programming mode.
- **Barista Programming** - The parameters included within this level are the ones the operator can change so as to affect the quality of the espresso. No access password will be required.

Display	Operating Procedure
<div data-bbox="166 611 239 651" style="border: 1px solid black; padding: 2px; display: inline-block;">93.5</div>  <div data-bbox="166 707 239 747" style="border: 1px solid black; padding: 2px; display: inline-block;">Prg</div> <small>AV version</small>  <div data-bbox="166 792 239 831" style="border: 1px solid black; padding: 2px; display: inline-block;">Eb</div> <small>EE version</small>  <div data-bbox="166 900 239 940" style="border: 1px solid black; padding: 2px; display: inline-block;">End</div>	<p style="text-align: center;"><b>“Barista” Programming Level</b></p> <ol style="list-style-type: none"> <li data-bbox="310 615 1058 691">1 While the espresso machine is on, press and hold the button T3 . After approximately 5 seconds the following display will appear.</li> <li data-bbox="310 751 1493 803">2 This is “Barista” programming level, which has the following functions: programming the brewing amount for each button, setting coffee boilers, pre-infusion and enabling or disabling cup warmer resistance, if present.</li> <li data-bbox="310 887 1174 939">3 To exit programming mode, scroll to the exit menu, using the buttons T1 or T2. Press the T3 button to confirm the exit.</li> </ol>

## Cleaning Cycles



### Description

- This parameter allows the operator to carry out the washing of the coffee groups, in an automatic way, by running multiple cleaning cycles.
- This espresso machine has a group rinsing function (rinsing jets) integrated in the electronics.
- Rinsing procedure purpose is giving the operator more flexibility and freedom with regard to these operations.
- Do not perform the cleaning procedure when other groups are dispensing coffee.

Display	Operating Procedure
	<p><b>1</b> When the espresso machine is on, press the continuous button T3 and the button T1 at the same time in order to activate washing procedure. This enables the washing procedure of each group.</p> <p><b>2</b> When activated, water pump comes into operation and the electric valve of the specific group being washed will turn on and off the cycle. There are about 10 preset cycles with an interval of 4 seconds. To manually stop rinsing procedure, press any key.</p> <p><b>NOTE:</b> In order to properly rinse the groups, put a small amount of detergent in a blank portafilter basket and insert it in the group to be rinsed before activating rinsing process. Rinse the group using a normal filter in the portafilter, by running hot water through it several times.</p>



### WARNING



**MOST DETERGENTS CAUSE FOAMING DURING CLEANING PROCESS.  
THIS FOAM GATHERS AT THE DRAIN BOX AND CAN BLOCK WASTE WATER FROM DRAINING PROPERLY.  
RINSING MULTIPLE GROUPS SIMULTANEOUSLY COULD CAUSE THE DRAIN BOX TO OVERFLOW.**

## “Barista” Programming

### Program Dose



### Description

- This parameter allows the operator to program the amount of coffee (brewing amount) for each Selection Indicator.
- Once programmed, Selection Indicator remains lighted.





Display	Operating Procedure
	<p><b>1</b> When the espresso machine is turned on, press and hold the the button T3 to access “Barista” programming. After about 5 seconds the following screen will be displayed.</p>
	<p>In order to program coffee brewing time, press the dose button to start and then press it again to stop when the desired dose is achieved.</p> <p><b>2</b> The button you pressed lights up steadily when programming is completed. This operation must be repeated for each dose button you want to set. Buttons can be programmed in any sequence.</p>

## Coffee Boiler

### Description

- This parameter allows the operator to enable/disable coffee boiler.



Display	Operating Procedure
	<p><b>1</b> When the espresso machine is turned on, press and hold the the button T3 to access “Barista” programming. After about 5 seconds the following screen will be displayed.</p>
	<p><b>2</b> Move between parameters using the buttons T1 or T2 until the display will show the following:</p>
	<p><b>3</b> Press the T3 button to enter the menu.</p>
	<p><b>4</b> Move between the parameters using the buttons T1 and T2 to select 001 (ENABLED) or 000 (DISABLED), press the T3 button to confirm desired option. If you have chosen the option ENABLED you can set the following parameters.</p>

## “Barista” Programming

### Coffee Boiler

#### Description

- This parameter allows the operator to program the coffee boiler temperature.



Display	Operating Procedure
	<b>1</b> When the espresso machine is turned on, press and hold the the button T3 to access “Barista” programming. After about 5 seconds the following screen will be displayed.
	<b>2</b> Move between the parameters using the buttons T1 or T2 until the display will show the following:
	<b>3</b> Press the T3 button to enter the menu.
	<b>4</b> Move with the buttons T1 and T2 to set the desired temperature, press the T3 button to confirm the value. In the case of an espresso machine having multiple boilers you can set the temperature also on coffee boiler. The temperature indicated on the left is group actual temperature, while the one on the right is set temperature.







## Clock Adjust



### Description

- This parameter allows the user to set the time of the day and the day of the week.
- This parameter is used to display time and is also used by “Auto On/Off” parameter.
- There are 4 changeable values within this parameter:
  - Hour;
  - Minute;
  - Day of week;
  - Hour Format (12h or 24h).

Display	Operating Procedure
	<b>1</b> When the espresso machine is turned on, press and hold the the button T3 to access “Barista” programming. After about 5 seconds the following screen will be displayed.
	<b>2</b> Move between the parameters using the buttons T1 or T2 until the display will show the following:
	<b>3</b> Press the T3 button to enter the menu.
	<b>4</b> Use T1 and T2 buttons to set the time.





## “Barista” Programming

### Clock Adjust



### Description

- This parameter allows the user to set the time of day and the day of the week.
- This parameter is used to display time and is also used by the “Auto On/Off” parameter.
- There are 4 changeable values within this parameter:
  - Hour;
  - Minute;
  - Day of week;
  - Hour Format (12h or 24h).





Display	Operating Procedure
	<b>5</b> Use T1 and T2 buttons to set the minutes.
	<b>6</b> Use T1 and T2 buttons to set the day of the week.
	<b>7</b> Use T1 and T2 buttons to set the time (12h or 24h).
	<b>8</b> Use T1 and T2 buttons to set the automatic weekly ON / OFF of the espresso machine with the times indicated via the Wi-Fi.

## Cup Warmer

### Description

- This parameter allows the operator to enable or disable cups heating function.



Display	Operating Procedure
	<p><b>1</b> When the espresso machine is turned on, press and hold the the button T3 to access “Barista” programming. After about 5 seconds the following screen will be displayed.</p>
	<p><b>2</b> Move between the parameters using the buttons T1 or T2 until the display will show the following:</p>
	<p><b>3</b> Press the T3 button to enter the menu.</p>
	<p><b>4</b> Move between the parameters using the buttons T1 and T2 to select 001 (ENABLED) or 000 (DISABLED), press the T3 button to confirm the option. If you have chosen the option ENABLED you can set the following parameters.</p>





## “Barista” Programming

### Crono Function



### Description

- When enabled, this parameter displays a timer that times each shot.
- The timer is reset each time a button on the keypad is pressed.





Display	Operating Procedure
	<p><b>1</b> When the espresso machine is turned on, press and hold the the button T3 to access “Barista” programming. After about 5 seconds the following screen will be displayed.</p>
	<p><b>2</b> Move between the parameters using the buttons T1 or T2 until the display will show the following:</p>
	<p><b>3</b> Press the T3 button to enter the menu.</p>
	<p><b>4</b> Move between the parameters using the buttons T1 and T2 to select 001 (ENABLED) or 000 (DISABLED), press the T3 button to confirm the option. If you have chosen the option ENABLED you can set the following parameters.</p>

## Steam Wand

### Description

- This parameter allows the operator to program the steam wand temperature.



Display	Operating Procedure
	<b>1</b> When the espresso machine is turned on, press and hold the the button T3 to access “Barista” programming. After about 5 seconds the following screen will be displayed.
	<b>2</b> Move between the parameters using the buttons T1 or T2 until the display will show the following:
	<b>3</b> Press the T3 button to enter the menu.
	<b>4</b> Move with the buttons T1 and T2 to set the desired temperature, then press the T3 button to confirm the value.



## “Barista” Programming

### Exit Menu



### Description

- This parameter allows the operator to exit the “Barista” programming and return to the normal use of the espresso machine.

Display	Operating Procedure
	<b>1</b> Press the T3 button to exit “Barista” programming and return to the normal use of the espresso machine.
	<b>2</b> Now the espresso machine is in normal operation mode.



**la marzocco**  
handmade in florence

## DICHIARAZIONE DI CONFORMITÀ UE EU CERTIFICATE OF CONFORMITY

Il sottoscritto Roberto Bianchi dichiara che le macchine da caffè sotto identificate:  
The undersigned Roberto Bianchi hereby declares that the following coffee machine:

Tipo/Type: LC-S 1AV, LC-S 1EE, LC-S 2AV AC, LC-S 2AV AW, LC-S 2AV HC, LC-S 2AV HW, LC-S 2AV LC, LC-S 2AV LC, LC-S 2AV LW, LC-S 2EE AC, LC-S 2EE AW, LC-S 2EE HC, LC-S 2EE HW, LC-S 2EE LC, LC-S 2EE LW, LC-S 3AV HC, LC-S 3AV HW, LC-S 3AV LC, LC-S 3AV LW, LC-S 3EE HC, LC-S 3EE HW, LC-S 3EE LC, LC-S 3EE LW, LC-S 4AV HC, LC-S 4AV HW, LC-S 4AV LC, LC-S 4AV LW, LC-S 4EE HC, LC-S 4EE HW, LC-S 4EE LC, LC-S 4EE LW.

Rispettano i requisiti essenziali delle seguenti direttive: 2014/30/UE EMC, 2014/35 Bassa tensione, 2014/53/UE RED, DPR 777/82 compreso Art. 5-bis punto 1, 2023/2006/CE, 2004/1935/CE Materiali e gli oggetti destinati a venire a contatto con i prodotti alimentari, 2014/68/UE attrezzature a pressione relativa per la cat. 1 modulo A, 2011/65/UE e (UE) 2015/863 Rohs III  
In quanto conforme alle seguenti norme: EN60335-2-15, EN60335-2-75, EN62233, EN55014-1, EN55014-2, EN61000-3-2, EN61000-3-3, EN61000-3-11, EN62311:2008, ETSI EN 301-489-1, ETSI EN 301-489-17, ETSI EN 300 328, ETSI EN 301 893.

Complies with essential requirements of the following directives: 2014/30/UE EMC, 2014/35 Low voltage, 2014/53/UE RED, DPR 777/82 included Art. 5-bis point 1, 2023/2006/CE, 2004/1935/CE Materials and articles intended to come into contact with food, 2014/68/UE pressure equipment for cat. 1 module A, 2011/65/UE and (UE) 2015/863 Rohs III

Since the machine conforms to the following standards: EN60335-2-15, EN60335-2-75, EN62233, EN55014-1, EN55014-2, EN61000-3-2, EN61000-3-3, EN61000-3-11, EN62311:2008, ETSI EN 301-489-1, ETSI EN 301-489-17, ETSI EN 300 328, ETSI EN 301 893.

Scarperia (Florence), Italy

La Marzocco srl  
Roberto Bianchi  
Chief Operating Officer  
Direttore Operativo

La Marzocco Srl Headquarters | Sede Operativa: Via La Torre 14/H, Loc. La Torre, 50038 - Scarperia e San Piero (FI), Italy  
T. +39 055 849191 | F. +39 055 8491990 | info@lamarzocco.com | www.lamarzocco.com

La Marzocco Srl Legal Address | Sede Legale: Viale Giacomo Matteotti 25, 50121 - Florence (FI), Italy  
Codice Fiscale, P.IVA e Registro Imprese Firenze: nr. 04040140487, Capitale Sociale: 41.600,00 Euro i.v.

