

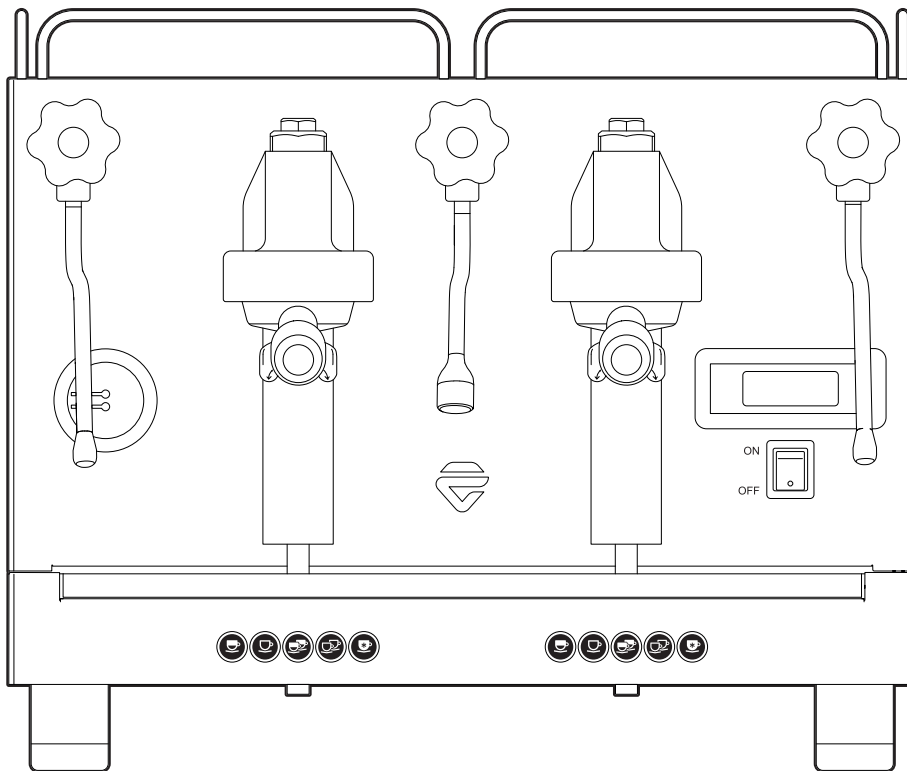

User manual



*	PL2SVX-EU	PL2SVX-AUS	PL2SVX-UK	PL2SVX-CUS
	230 V 50 Hz	240 V 50 Hz	240 V 50 Hz	220 V 60 Hz
	E+F	I	G	B



THANK YOU FOR CHOOSING A LELIT PRODUCT

LELIT has the right to make changes to the machine according to the needs of the different individual countries and according to the advancement of the technical progress.



**Save the box and
all the packing material!**

LELIT has studied the external and internal packing of your coffee machine to help you re-use it in case of maintenance or repair need.

Index

Product overview	4
1. General information	5
2. Installation information	5
3. Electrical installation	6
4. Equipotential connection	6
5. Water mains connection	7
6. Getting the machine ready for use	7
7. Installation check-up	7
8. Information for end user/operator	8
9. Warnings	10
10. Maintenance and repairs	10
11. Turning the machine ON	11
12. Warming up phase	11
13. Coffee extraction	11
14. Dispensing other hot beverages	14
15. Cleaning and maintenance	14
16. Troubleshooting – Solving the most common problems	16
17. Advices – Tips – Useful Images	17

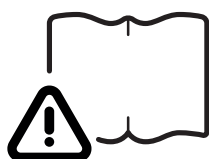
**ATTENTION:**

Read the safety notes carefully before using this product.



PIC. 1

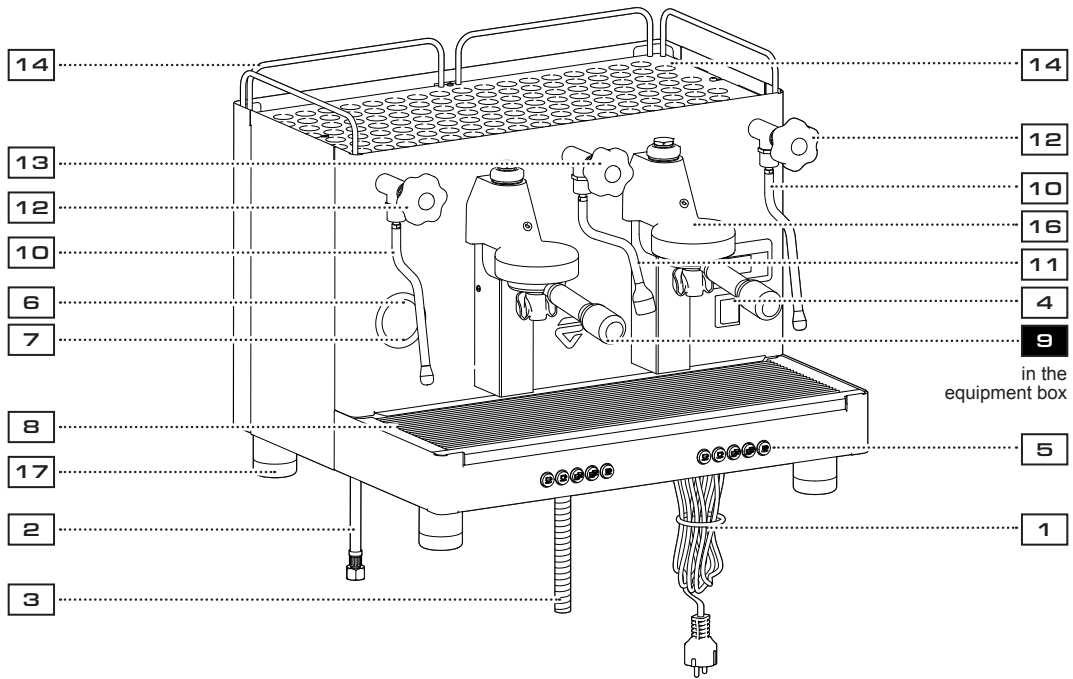

4

Product overview

- | | |
|---|---------------------------------|
| 1. Power cord | 10. Steam wand |
| 2. Tube for water mains connection | 11. Hot water wand |
| 3. Water discharge tube | 12. Steam distribution knob |
| 4. Main switch | 13. Hot water distribution knob |
| 5. Selection panel | 14. Cup warmer rail |
| 6. Manometer for steam boiler pressure | 15. Cup warmer |
| 7. Manometer for pump pressure | 16. Coffee distribution group |
| 8. Drip tray | 17. Adjustable feet |
| 9. LELIT58 filterholder with Coffee Slide chute | |

Equipment

- 2 LELIT58 filterholders with Coffee Slide spout (9)
- 2 LELIT58 2 doses filters (14-18 gr)
- 1 LELIT58 1 dose filter (9-11 gr)
- 1 LELIT58 blind filter for backflushing
- Plastic coffee tamper
- Espresso cup rack

Selection panels



1. General information

⚠ Attention. *Please read the warnings and rules in this User's Manual carefully before using or handling the machine in any way because they provide important information regarding safety and hygiene when operating the machine. Keep this booklet handy for easy reference.*

The machine was designed only for preparing espresso, coffee and hot beverages using hot water or steam, and for warming cups.

The machine must be installed in a place where it is only used by carefully trained staff that knows the risks tied with using the machine.

The machine is for professional use only.

This appliance can be used by children aged from 8 years and above and persons with reduced physical, sensory or mental capabilities or lack of experience and knowledge if they have been given supervision or instruction concerning use of the appliance in a safe way and understand the hazards involved.

Children must always be supervised to prevent them from playing with the machine.

Children shall not play with the appliance.

The machine must not be left unattended or used outdoors.

If the machine is stored in rooms where the temperature can drop below freezing, empty the boiler and water circuit tubes.

Do not expose the machine to atmospheric agents (rain, sun, cold).

Do not clean the machine with water sprays / jets.

The machine noisiness does not overcome 70 dB(A).

Should the power cord be damaged, please let only authorized, technically qualified people replace it, to avoid any risk.

If the machine is used improperly or for purposes other than those described above, it can be a source of danger. The manufacturer will not be held responsible for damages caused by improper use of the machine.

2. Installation information

THESE CHAPTERS IN THE MANUAL ARE JUST FOR QUALIFIED, AUTHORIZED TECHNICAL STAFF ONLY.

⚠ Attention. *Installation, dismantling and adjustments must only be performed by qualified and authorized technicians. Carefully read the warnings and rules in this manual because they provide important information regarding safe installation, use and maintenance of the machine, before operating with it. Keep this booklet handy for easy reference.*

Staff responsible for moving the machine must realize the risks in moving heavy loads. Move the machine carefully, using the correct lifting equipment (fork lift, for example). In case of moving the machine by hand, make sure: enough people are available for the task, depending on the machine weight and handling. Always use the necessary safety equipment (shoes/gloves).

After removing the machine from its packing materials, make sure that the machine and its safety devices are intact.

Packing materials (plastic bags, polystyrene foam, staples, etc.) must be kept out of the reach of children because they are potentially hazardous.

Before plugging in the machine, make sure that the information on the data label (voltage, etc.) matches that of the electrical and water systems.



Completely unwind the power supply cord. Should the power cord be damaged, please let only authorized, technically qualified people replace it.

The coffee machine should sit on a flat, stable surface at least 20 mm from walls and from the counter. Keep in mind that the highest surface on the machine (the cup warmer) should sit at a height of at least 1.2 meters. Make sure there is a shelf nearby for the accessories.

Room temperature must range between 10° and 32°C (50°F and 90°F).

An electrical outlet, plumbing connections and a drain with siphon must be in the immediate vicinity.

Do not install in rooms (kitchens) that are cleaned with jets of water.

Do not obstruct openings or ventilation and heat vents.

Do not install the machine outdoors.

3. Electrical installation

Prior to installation, make sure there is a circuit breaker installed with a distance between the contacts that allows for complete disconnection when there is a category III overload and that provides protection against current leakage equal to 30 mA. The circuit breaker must be installed on the power supply in compliance with installation rules. If the power supply is not working properly, the machine can cause transitory voltage drops.

The electrical safety of this machine is only ensured when it is correctly connected to an efficient earthing system in compliance with the electrical safety laws in force. This fundamental safety requirement must be verified. If in doubt, require that a qualified electrician inspects the system. The manufacturer cannot be held responsible for any damage caused by the lack of an earthing system on the electrical supply.

It is inadvisable to use adaptors, multiple plugs, and/or extension cords. If their use is indispensable, only use simple or multiple adaptor plugs and extension cords that are in compliance with safety laws. Make sure that these devices do not exceed the voltage capacity marked on the simple adaptor and on extension cords, and the maximum voltage marked on the multiple adaptor.

Check that the type of connection and voltage correspond with the information on the technical data label.

4. Equipotential connection

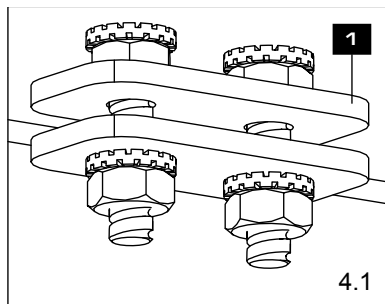

This type of connection, required by some laws, prevents differences in the electric potential level between the earthing connections of equipment installed in the same room. This machine is provided with a clamp (1) **UNDERNEATH THE BASE** for the connection of an external equipotential conductor. After installation, this type of connection **MUST** be made (Pic. 4.1).

Use a conductor with a nominal section in compliance with the laws in force.

Connect one end of the conductor to the clamp and the other end to the earthing of adjacent equipment.

Failure to follow this safety norm releases the manufacturer from any responsibility for machine breakdowns or damage to people or property.

⚠ Attention. *Do not connect to the power supply earthing because it is not considered an equipotential cable connection. Bear in mind that LELIT srl a socio unico is not responsible for damage caused by improper electrical connections, and that the installer is responsible for any damage.*

5. Water mains connection

Water used in coffee machines must be potable and suitable for human consumption (see laws and regulations in force).

Check that the water pH level is 6-8°F and complies with the laws in force and that the chloride value is less than 100 mg/l.

If the values do not fall within the limits, an appropriate water treatment device must be inserted (respecting the local laws and compatible with the machine).

If the machine uses water with a hardness exceeding 8°F (4.5 °D), a specific maintenance plan must be implemented according to the hardness detected and machine usage.

Use only the supplied parts for the connection: water inlet and outlet tubes, clamp for the water outlet tube. If other parts are installed, they must be new (not used) and they must be able to come in contact with potable water suitable for human consumption, according to any national rules that may be applicable.

Place the machine on a flat surface and stabilize it by adjusting and securing the feet.

Hook up the water connections respecting the hygiene, water safety, and antipollution laws in the country of installation.

If the water pressure can rise above 6 bar / 0.6 MPa, install a pressure reducer set at 3 bar / 0.3 MPa.

Place the end of the water draining tube in a drain with a siphon for inspection and cleaning.

The curves of the draining tube must NOT bend.

6. Getting the machine ready for use

Once the hydraulic and electrical installations are over, proceed to get the machine ready for use.

Open the tap of the water mains and close the general protection switch.

Switch on the main switch I/O: the relative pilot light will go on.

The self-levelling device will start working in order to fill the boiler with water until the right level is automatically reached. During the first filling of the boiler, it's recommended to open the steam tap and close the tap at the end of this operation to let eventual air come out from the wand.

Once the water has been automatically pumped into the boiler, the boiler heating element will start heating it.

Dispense half a litre of water from each extraction group.

Wait until the machine has reached the exercise nominal temperature.

The machine is now ready for use.

If after turning on the machine, the display shows the written "OFF", select and press the K3GR1 button to start on the machine.

7. Installation check-up

Once the installation is over, check if the machine is working properly.

Verify that there are no leaks from the connections or tubes.

Verify that boiler and operating pressure comply with the nominal values, between 1 and 2 bar.

Verify that the pressure gauge and the pump pressure are working properly.

Verify that the self-leveling device is working properly.

Verify that the expansion valve is working properly.

⚠ Attention. Once the machine has been installed and is ready for use, before allowing the operator to start using the machine, wash the internal components by following the instructions below.

EXTRACTION GROUPS

Hook up the filter holders to the groups (without coffee).

Let each group dispense water for about a minute.

HOT WATER

Continuously dispense hot water (by opening the relative knob) until at least 4 liters of water come out of the machine.

STEAM

Dispense steam from the nozzles for about a minute, using the appropriate knob.

8. Information for end user/operator

8.1 First steps

⚠ Attention. Before you start operating the machine, wash the internal components following the instructions indicated below. These steps must be repeated at least once a day and when the machine has not been operated for more than 8 hours.

⚠ Attention. For a correct programmed cleaning procedure follow the indications described in chapter “15. Cleaning and maintenance”.

EXTRACTION GROUP

Hook up the filter holders to the groupsheads (without coffee).

Let each group dispense water for about a minute.

HOT WATER

Continuously dispense hot water (by opening the relative knob) until at least 4 liters of water come out of the machine.

STEAM

Dispense steam from the nozzles for about a minute, using the appropriate knob.

8.2 During daily use

The machine can work on 3 different temperature profiles, according to the periods of non-use.



(8.1)



(8.2)

The temperature measure unit can be set from the technical menu: enter the OFF mode (Pic. 8.1) (K5GR1+K3GR1 and keep K5GR1 pressed for 10 seconds), scroll the menu by pressing the K5GR1 until you reach the screen 13, where you have the possibility to enable or disable the temperature function by pressing K1GR1 or K2GR1. Confirm selection by pressing K5GR1 (Pic. 8.2).

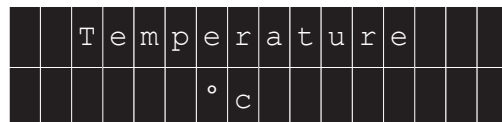

(8.3)



(8.4)

In the following screen (screen 14) you can choose the temperature measure unit (°C/°F) by pressing K1GR1 or K2GR1 (Pic. 8.3). Confirm selection by pressing K5GR1.

In the screen 15 you can use the K1GR1 and K2GR1 to set the temperature value that the boiler will reach during the use of the machine (this value is between 110°C and 130°C).

Confirm selection by pressing K5GR1 (Pic. 8.4). This temperature value will determine the steam

boiler pressure. During the use of the machine, this value can fluctuate (between 1 and 2 bar).

STEAM DISPENSING

Before heating the beverage (water, milk, etc.), open the steam knob for at least 2 seconds and let the condense water come out of the wand.

COFFEE EXTRACTIONS

If the machine has not been used for more than 15 minutes, the operator can set a lower temperature than the normal usage temperature. In the screen 16, you can set the value between 110°C and 130°C (Pic. 8.5).

T	e	m	p	e	r	a	t	.	>	1	5	m		
				1	2	0		°	c					

(8.5)

If the machine has not been used for more than an hour, before making coffee, dispense about 100 cc of water through the extraction group.

HOT WATER DISPENSING

If the machine has not been used for more than an hour, before using the hot water, dispense about 200 cc.

CLEANING THE COFFEE CIRCUITS

Please read the specific section to learn more about this.

ENERGY SAVING

You can enable the **Energy Saving/Stand by function** in screen 19: if the machine has not been used for more than 240 minutes, the boiler temperature drops until it reaches the default value, 110°C.

This last setting can be enabled or disabled, without having the possibility to modify the value of the set temperature.



9. Warnings



⚠ Danger of burns. *The areas marked with "CAUTION: HOT" label become very hot. PARTICULAR CARE IS NEEDED WHEN CLOSE TO THESE AREAS.*

9.1 General warning

The manufacturer disclaims all liability for damages to items or persons due to improper use or due to the coffee machine being used for reasons other than its intended use.

Never operate the espresso machine with wet hands or bare feet.

Do not place hands or other body parts close to the coffee distribution points or near to the steam and hot water wands.

Ensure that the machine is not handled by children or people that have not been properly instructed regarding its correct use.

On the cup warmer place just the cups/glasses that need to be used in conjunction with the coffee machine.

Ensure that the cups/glasses are completely dry before placing them on the cup-warming surface.

No other objects should be placed on the cup warmer.

9.2 Usage discontinuity

When the machine remains unused for a long period of time (at night or during holidays), the following operations should be performed:

Unplug the machine or switch off the main switch.

Close the main water tap.

If the machine remains unused for more than 4 days, drain the boiler by means of the tap supplied.

NB: upon restart perform the operations described in chapter 6.

Non-compliance with these safety measures exonerates the manufacturer from all liability for malfunctions or damage to persons or items.

10. Maintenance and repairs

⚠ Attention. *Maintenance performed by unqualified people can compromise the safety and conformity of the machine. Let only qualified, authorized technicians operate/repair the machine.*

To ensure safety during operation, it is absolutely necessary to: follow the manufacturer's instructions; have qualified, authorized technicians periodically check that all safety devices are intact and work properly (the first inspection must be done after 3 years from the purchase date and, afterwards, every year).

In case of malfunction, turn off the machine, turn off the main on-off switch and call the service center.

If the power supply cord is damaged, turn off the machine and ask for a replacement cord from the service center.

Only use original spare parts guaranteed from the manufacturer. The manufacturer warranty will cease if other non-original parts will be used.

After maintenance always perform the installation CHECK-UP as indicated in the specific section of this manual.

The access to the service area is restricted to persons having knowledge and practical experience of the appliance, in particular as far as safety and hygiene are concerned.

Cleaning and user maintenance shall not be made by children without supervision.

1 1. Turning the machine ON

⚠ Attention. Before setting the machine at work, make sure that: the main electric power switch is on and that main water tap is open.

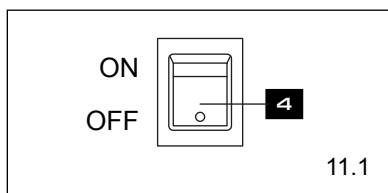

ELECTRIC SWITCH ON

Press the main switch (4) ON (Pic. 11.1). The boiler will be filled with water until the foreseen level. The “Heating phase” will start. At the end of the working day, the machine can go into the Stand by mode (automatically after 240 minutes of inactivity) or can be turned off by pressing the main switch (4) OFF.

1 2. Warming up phase

⚠ Attention. Do not put any cloth on the cup warmer..

While waiting for the machine to get ready, fix the filterholders (9) in the extraction groups. Do not cover the cup warmer with cloths to prevent the over-heating of the machine. When the display shows the exercise temperature, the machine is ready for use.

1 3. Coffee extraction



13.1

1. Unhook the filterholder (9) from the extraction group.
2. Fill the filter with the desired dose of ground coffee.
3. Press the coffee with a tamper and clean the filter edges from eventual coffee residues/rests.
4. Firmly lock the filterholder (9) to the grouphead and make sure that the group gasket provides a good seal.
5. Place the cup/cups under the filterholder dispensing spouts.
6. PRE-PROGRAMMED DOSES: press one of the switches (K1-K2-K3-K4) and the pre-programmed dose will be dispensed. Water will stop flowing out once the programmed quantity will be reached.
7. CONTINUOUS DISPENSING: to have continuous dispensing, press the continuous/stop switch K5 (Pic. 13.1).
8. Attention: if the machine is dispensing coffee and you press any of the switches of the same selection panel, the dose will be interrupted.
9. To brew other coffees, remove the filterholder, clean it from the coffee rests with a wet soft cloth and repeat the above mentioned operations.





13.1 Coffee dose programming

The machine has a selection/control panel for each extraction group:







12

Through the control panel it's possible to perform the machine functions:

Button	Function	Special function
	1 espresso	+
	1 coffee	-
	2 espressos	
	2 coffee	
	Continuous extraction	Enter programming/scroll screen/confirm function

Reference Pic. 13.2

Button	Function	Special function
	1 espresso	
	1 coffee	
	2 espressos	
	2 coffee	
	Continuous extraction	

Reference Pic. 13.3

Before programming the coffee dispensing buttons fill the filterholder with the correct dose of ground coffee. Don't use coffee rests for programming the doses. It's possible to modify and save the doses (through volumetric control) by following the procedure described below:

1. To enter the programming mode: press one of the **K5** buttons of any of the 2 groups and keep it pressed for more than 5 seconds; the LED of the **K5** button will blink on both selection panels (Pic.13.4).
2. Within **30 seconds** (after 30 seconds you are out of the programming mode) press any of the 4 switches for the different doses (for example switch **K1GRx**). The relative led of **K1GRx** of the dose you are programming and the LED of **K5GRx** will stay on (Pic.13.5).

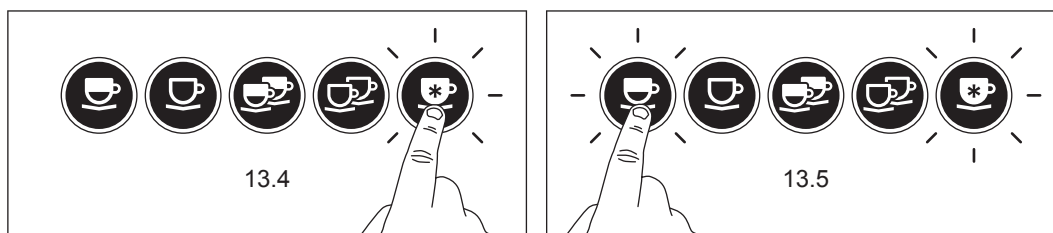

3. Once the desired quantity of coffee for that dose is reached, press the selected button again and the serving dose will be memorized. The machine will go back to doses programming mode. At the same time, the LED of the programmed dose will go off and the LED of both K5 buttons will blink; now it's possible to program the other doses without repeating the operation described in point 1.

4. To program the other doses (if the time-out of 30 seconds has not elapsed yet) repeat points 2 and 3 consequently.

If the time-out of 30 seconds has already elapsed and you are out of the programming mode, you need to repeat all the operations of points 1-2-3 to enter in the programming mode again.

To exit the programming mode without modifying any of the parameters just wait for 30 seconds, without pressing any button.

IMPORTANT: what has been programmed on the **FIRST GROUP** is **ALWAYS** automatically transferred also **TO THE OTHER GROUP**. This does not mean that you cannot program the other group independently from group 1, you can do so by repeating the operations in points 1-2-3 also on the other group.

13.2 Washing cycle

The washing cycle enables the cleaning of the extraction groups and can be performed as follows:

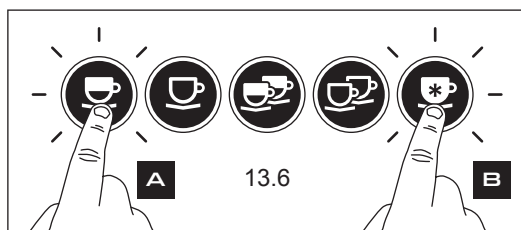

Press the continuous/stop button (K5GRx) (A) and then the switch (K1GRx) (B) of the group where you want to perform the washing cycle (Pic.13.6).

The washing cycle will be confirmed by the synchronic blinking of the relative LEDs of the 2 buttons that you have pressed one after the other (K5GRx + K1GRx); the blinking will continue during the entire washing cycle and will stop if any of the other switches of the same panel will be pressed. In this case the washing cycle will be interrupted and the LEDs will go back to the ON position. It's possible to undergo the washing cycle using an appropriate detergent powder (see chapter 15).

The extraction group that undergoes the washing cycle will dispense water 5 times through the group. Once the cycle is over, the selection panel will go back to the normal functioning mode.

It's possible to do the washing cycle at the same time on both groups, as many times as desired during the working day.

In chapter 15. **CLEANING AND MAINTENANCE** you'll find out how to perform the washing cycle with the recommended detergent powder.

14. Dispensing other hot beverages

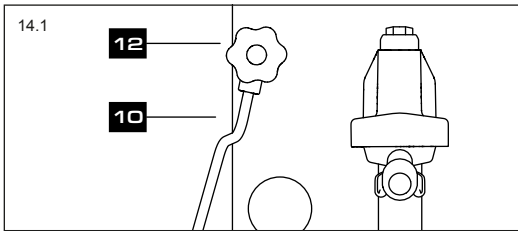

STEAM DISPENSING

Once the machine is ready, open the steam knob (12) anticlockwise with the steam wand (10) directed on the drip tray and let the initial condense water come out; then close the steam knob to stop the function (Pic. 14.1).

Completely immerse the steam nozzle (10) into the jug with the beverage. Gradually open the steam knob (12) anticlockwise to let the steam come out and turn it clockwise to stop it.

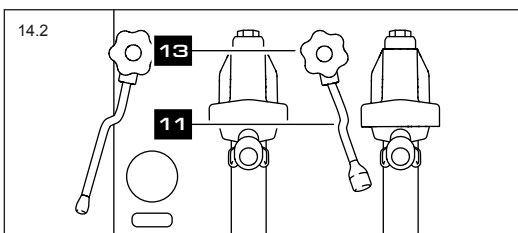

HOT WATER DISPENSING

Place the jug under the hot water wand (11). Open the hot water knob (13) anticlockwise to let the water come out and turn it clockwise to stop it (Pic. 14.2).

MILK FROTHING FOR CAPPUCCINO

Use a tall narrow jug and fill it up to about the half-way mark.

Once the machine is ready, open the steam knob (12) anticlockwise with the steam wand (10) directed on the drip tray and let the initial condense water come out; then close the steam knob.

Plunge the steam wand (10) into the milk.

Gradually open the steam knob (12) and heat the milk for a few seconds.

When the required amount of froth has been made and the temperature is sufficiently warm, stop the steam flow by turning the steam knob (12) clockwise.

Once the frothing is over, clean the steam wand (10) thoroughly with a sponge or a clean cloth.

NOTE. At the end of each steam dispensing phase, clean the inside of the steam nozzle as follows: turn the nozzle towards the drip tray and carefully activate the steam dispensing at least once, clean the steam wand thoroughly with a sponge or a clean cloth.

15. Cleaning and maintenance

 **Attention.** For the correct application of the food safety system HACCP, please follow the instructions in this chapter.

15.1 Groups cleaning

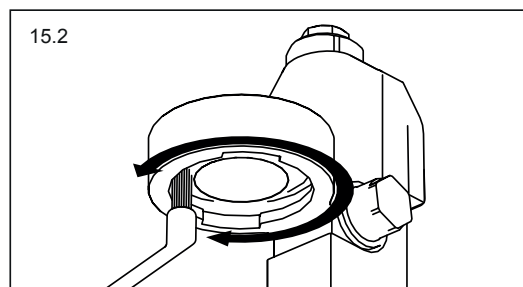
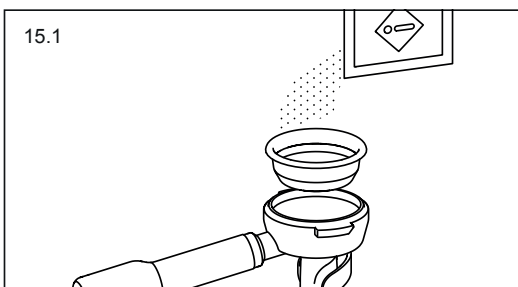

Procedure to be done at the end of each working day, on each grouphead.

Clean the group gasket with a brush (Pic. 15.2).

Insert the blind filter in the filterholder.

Pour 3-5 gr of detergent powder (or 1 single bag of LELIT PLA9201) in the blind filter (Pic.15.1).

Hook the filterholder onto the grouphead and perform a washing cycle acting as described in paragraph 13.2.

Remove the filterholder and clean the shower filter with a sponge.

Rinse by letting the hot water come out of each group for 30 seconds.

15.2 Filterholders cleaning

Pour 1 litre of warm water and 10 gr of detergent powder (or 3 single bags of LELIT PLA9201) into a suitable basin.

Remove the filters from the filterholders.

Immerge and leave the filters and filterholders in the solution for at least 20 minutes.

Remove any residues with a sponge and rinse with plenty of warm water.

Place the filters in the filterholders, making sure that the filter fixing spring is in the correct position.

15.3 Cleaning of the steam and hot water wands

Use a clean sponge to wash the wands with hot water and remove any eventual organic residue. Rinse carefully.

To clean the steam nozzle inside, proceed as follows: turn the nozzle towards the cup tray and carefully activate the steam dispensing at least once.

15.4 Cleaning of the water drip tray

Remove the drip tray and the relative grate and rinse both with tap water.

15.5 Cleaning of the water discharge tray

At the end of the working day, pour a jug of hot water into the discharge tray, removing any eventual organic residue.

15.6 Cleaning of the appliance body

Use a soft cloth and cleaning products WITHOUT ammonia or abrasives to remove any eventual organic residue in the work area. Do not spray liquids into the panel slots.

15.7 Cleaning of the coffee circuits – descaling

The descaling procedure must be performed regularly to ensure a stable performance of the machine functions.

The frequency of the descaling cycle depends on the used water profile.

Contact your direct reseller/authorized installer for more details to program the correct descaling frequency.



16. Troubleshooting – Solving the most common problems

Before calling the service personnel, to avoid useless expenses, check whether the machine problem corresponds to one of the cases indicated below.

16

Malfunction	Cause	Solution
Leaking from the filterholder edge	Dirty group gasket	Clean the group gasket with a brush and/or replace the gasket with an original part.
Coffee extraction time too short	Too coarse coffee grinding degree The used coffee is too old	Use a finer grinding degree. Use fresh coffee.
Coffee comes out in drops	Filter holes blocked or filter holder outlet dirty Too fine coffee grinding degree	Clean the filter/the filterholder. Use a coarser grinding degree.
Water leak under the machine	Discharge tray blocked Discharge tray hole blocked	Empty and clean the discharge tray. Clean the hole.
Steam pressure higher than 2 bar	Fake pressure inside the boiler	Open the steam tap for few minutes.
Steam comes out from underneath the drip tray	Too much water inside the boiler Check the steam pressure: if it is above 2,5 bar, probably there is a problem with the filling of the boiler or the heating of the steam boiler	Open the water tap and take out some litres of water.
Steam pressure lower than 0.8 bar	Check if the machine is in Stand By mode	Press a button to exit the Stand-by mode.
Coffee temperature too hot/cold	Adjust the temperature using the display	See the following link: https://youtu.be/5jC4WnZankw
Machine does not heat	Check the water mains pressure (pump manometer) Check the pressure on the steam manometer	Turn off and turn on the machine. RESET ¹ the unit: if the reset does not work, please contact your reseller/authorized technician. If the pressure is at 0, it means that there may a problem with the heating, please contact your reseller/authorized technician.
Water comes out from the drainage tray	Check the slope of the discharge tube	If this does not solve the situation, please contact your reseller/authorized technician.
No water comes from the water wand	Check, clean or replace the distribution filter	If this does not solve the situation, please contact your reseller/authorized technician.
The selection panel blinks, all functions are blocked	Turn off and turn on the machine	If this does not solve the situation, please contact your reseller/authorized technician.
The machine continues charging water	Check the water profile: it needs to be suitable for coffee machines	If this does not solve the situation, please contact your reseller/authorized technician.

1. RESET: to perform the RESET of the entire unit, turn the machine off, press the buttons 1-3-5 (K1GR1-K3GR1-K5GR1) at the same time and afterwards turn the machine on.

17. Advices – Tips – Useful Images

⚠ Attention. *This chapter is for the use of qualified and authorized technical staff only. The access to the service area is restricted to persons having knowledge and practical experience of the appliance, in particular as far as regards safety and hygiene.*

⚠ Attention. *The machine must be fed with water having a hardness between 3 and 9°F. It is forbidden the use of tubes and gaskets that have been already used.*

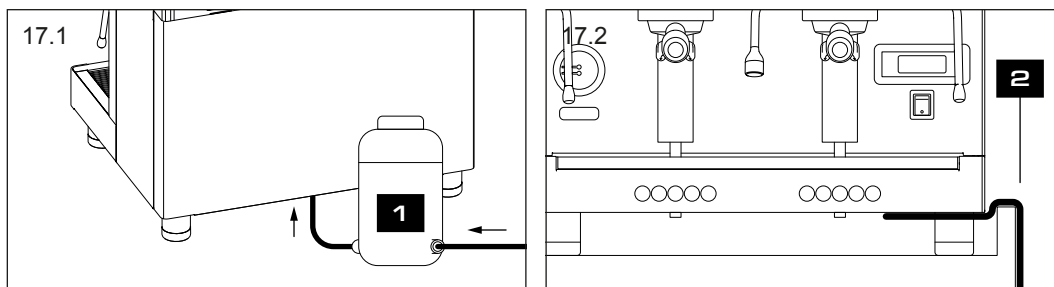

It is advisable to install a water softener (1) for the water connection of the machine (Pic.17.1).

⚠ Attention. *Before connecting the water softener to the machine, perform a rinsing cycle and wait until the water is clear. Only after this you can connect the water softener to the machine.*

⚠ Attention. *The manometer “PUMP” shows the inlet pressure (the hydraulic mains pressure). Therefore, even with the pump out of function, the manometer will never show “0” value. When the pump is off, the pressure does not have to exceed 5 bars. The hydraulic mains pressure we recommend is between 2-3 bars. If you register a higher or lower inlet pressure, please contact a specialist to adjust the pressure. Anyway, the inlet pressure must not exceed 5 bars to avoid damages.*

If the pressure of the mains is above 0.5 Mpa (5 bar), it is recommended to install a balanced pressure reducing valve for high pressure (a device in which any increase in the mains pressure does not affect the output pressure).

The water draining tube (2) must not bend to avoid water returns to the machine (Pic.17.2).

To complete the installation of the machine and assemble the cup warmer rail proceed as indicated below. Follow the assembling instructions carefully. In case of maintenance / opening the machine body, act the other way round.

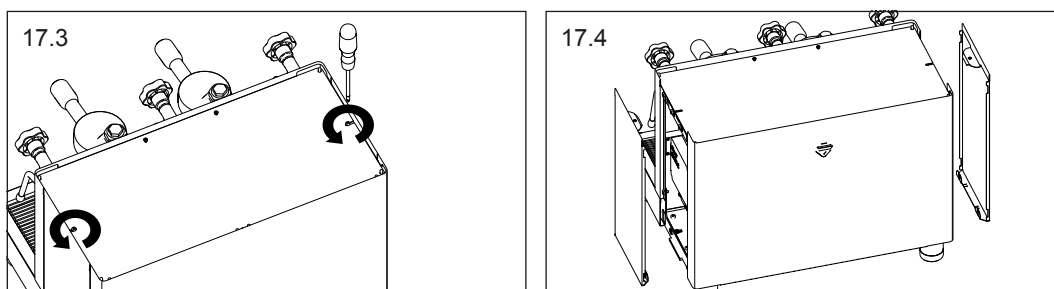

Loosen the two side screws using a PH2 Phillips screwdriver (Pic.17.3).

Remove the lateral panels (Pic.17.4).

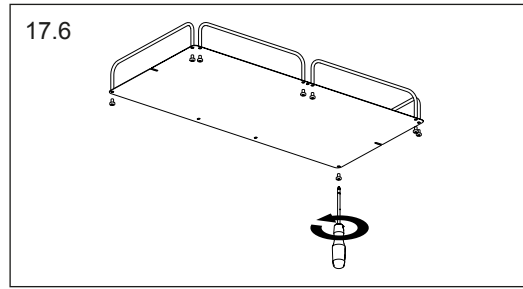
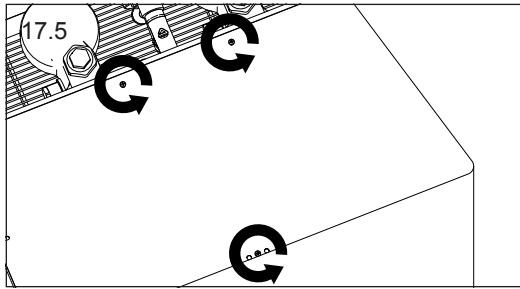

Use a PH2 Phillips screwdriver and remove the 3 fixing screws of the cup warmer shelf (Pic.17.5).

Use a PH2 Phillips screwdriver and tighten the 8 M screws (part#MC268/I) present in the package to fix the sides of the cup warmer shelf (Pic.17.6).

⚠ Attention. *The polished side of the shelf must face outwards (high).*

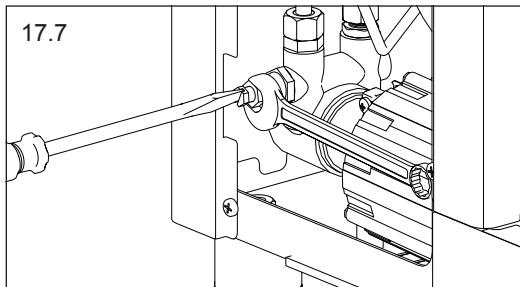

To adjust/set the pump pressure, act on the screw (10) after having loosen the locknut. By turning it clockwise, the pressure increases, anticlockwise, the pressure decreases. At the end tighten the locknut (Pic.17.7).



IMPORTANT INFORMATION

For the correct disposal of the product in accordance with EU DIRECTIVE 2012/19/EC and with Legislative Decree no. 151 of 25 July 2005. At the end of its working life, the product must not be disposed of as urban waste. It must be taken to a special authorised differential waste collection centre or to a dealer providing this service. Disposing of a household appliance separately avoids possible negative consequences for the environment and health caused by improper disposal and enables recovery of the materials it contains, with significant savings in energy and resources. The product is marked with a crossed-out wheeled bin as a reminder of the need to dispose of household appliances separately.



EC DECLARATION OF CONFORMITY

LELIT srl a socio unico declares under its own responsibility that the product: Coffee machine for professional use type: PL2SVX to which this declaration relates conforms to the following standards:

IEC 60335-2-75:2012, AMD1:2015, AMD2:2018;

IEC 60335-1:2010+ AMD1:2013+ AMD2:2016;

CISPR 14-1; CISPR 14-2; EN 55014-1; EN 55014-2; EN 61000-3-2; EN 61000-3-11; EN 62233:2008;

EN 50581:2012.

pursuant to directives:

2006/42/EC; 2011/65/EU; 1907/2006/EU

NB: This declaration is null and void should the machine be modified without our specific authorisation.

Castegnato, 04/07/2022

Emanuele Epis - Legal Representative

LELIT srl a socio unico
25045 Castegnato (Bs)



LELIT.COM

CE EAC

EN/7800056

©2022 LELIT srl
All Rights Reserved