

Using Your Pressure Gauge

Everything starts with the grind and dose, which create the resistance to achieve desired pressure and brewing time. “Flair-istas” who have mastered their technique will brew between 6 and 9 BAR at a time between 30-35 seconds. Your Flair 58 comes with a pressure gauge to ensure your espresso is to your specifications at all times. Please use the chart below to help you dial-in and target brewing in the “espresso zone” as seen on your gauge.

BREW TIME	PRESSURE				DANGER! STOP & DISCARD GROUNDS	CAUTION: Don't break your pressure gauge. Never brew in the “STOP - BREAKAGE” area of your gauge
	1-5 BAR	6-9 BAR	10-12 BAR	>12 BAR		
More Than 35 Seconds	More Pressure	Grind More Coarse	Grind More Coarse			
30-35 Seconds	Grind More Fine	Target Brew Range	Grind More Coarse			
Less Than 30 Seconds	Grind More Fine	Grind More Fine	Less Pressure			

Steps to Brew with Your Flair 58 & 58x

#1 - Prepare the Flair

(a) Preheat your Flair using one of the preheat options **(b)** Insert portafilter for preheat by aligning it with the brew base and **(c)** rotate the portafilter handle counterclockwise until it is firmly in place (Do no over-rotate)

#2 - Prepare the Portafilter

(a) Boil water **(b)** Grind 18-20 grams of freshly roasted beans with burr grinder **(c)** Remove portafilter from brew base, add grounds and tamp **(d)** Add puck screen flat on top of tamped grounds and re-insert portafilter

#3 - Prepare the Brew Head

Choose one method of filling your brew head from the valve plunger section

#4 - Brew your Espresso

(a) Slowly lower lever to build pressure and begin brewing **(b)** Target a shot duration of 30-35 seconds at 6-10 BAR **(c)** When desired shot weight/volume is reached, or lever is fully lowered, raise the lever to starting position

#5 - Purge your System

(a) Place an empty cup on drip tray **(b)** Expel remaining brew water by lowering lever all the way down and allow the remaining liquid to drain **(c)** Rotate portafilter clockwise to remove for cleaning

Cleaning Your Flair 58 & 58x

When managed correctly, your Flair 58 or Flair 58x will need minimal cleaning. Always ensure that your Flair 58's Preheat System is off and your brew head has cooled before cleaning. Never immerse or wash the entire brew head in water.

See our online “Safety and Instructions Guide” for more.

No Soap Needed!

Keep Outside Surface & Wires Dry!



1. Remove plunger by pulling out with stem while brewing cylinder is installed on base.
2. Use damp cloth to wipe the inside and bottom of the brew head. Also wipe the plunger.
3. For more thorough cleaning, place a cup beneath your Flair 58 and flush with cool water before wiping.

Learn faster by watching our video tutorials online at: <https://flairespresso.com/flair-58-tutorials/>

For troubleshooting write to us at: service@flairespresso.com

For warranty, upgrades and all other info, visit: <https://flairespresso.com>



28 Hammond Street, Suite B
Irvine, CA, 92618 USA
© Intact Idea, All Rights Reserved

Flair is a trademark of Intact Idea, LLC. Product designed in California, USA - Made in China

Flair 58

Video Tutorials



INSTRUCTIONS MANUAL

What's Included:

- | | |
|-------------------------------------|---|
| 1) Lever | 9) Brew Base |
| 2) Lever Assembly | 10) 58mm Portafilter |
| 3) Pressure Gauge | 11) Base |
| 4) Plunger Stem | 12) Preheat System Controller (Flair 58 ONLY) |
| 5) Lever Hook | 13) Drip Tray |
| 6) Valve Plunger (in Brew Cylinder) | 14) Tamper |
| 7) Brew Head Funnel (Flair 58 ONLY) | 15) Open Preheat Cap |
| 8) Brew Cylinder | 16) Puck Screen |
| | 17) Power Supply (Flair 58 ONLY - not shown) |

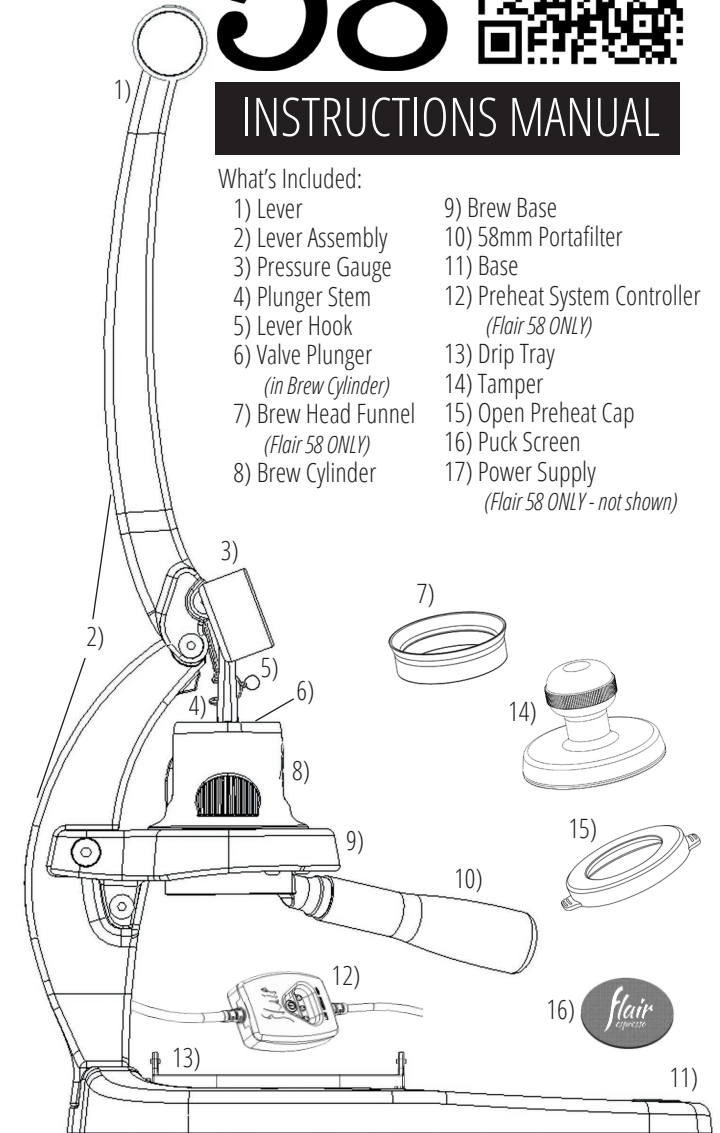

Getting Started With Your Flair 58

Welcome to the world of café-quality handcrafted espresso with your Flair 58! Before pulling your first shot, please follow the steps below to set-up your Flair. Also, please remember that your Flair 58 requires uniform grounds from a high-quality burr grinder.

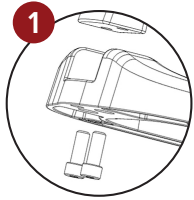

Bolt base & lever assembly together firmly

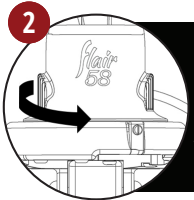

Remove preheat cap & install brew cylinder onto brew base. Rotate counterclockwise to lock

CAUTION: Do not attempt to rotate, reposition or remove the Silicone Sleeve as you may cause the brew head to fail.

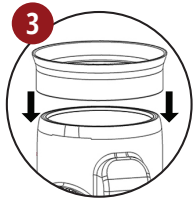

Flair 58 Only - Add Brew Head Funnel to Brew Head

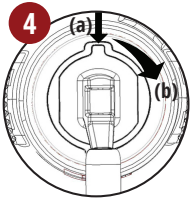

Align (a) plunger stem tabs to slots on valve plunger. Rotate (b) stem to lock. Push stem down to seal valve plunger. Gauge should face front

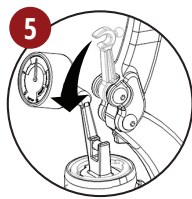

Lower lever hook and connect to plunger stem

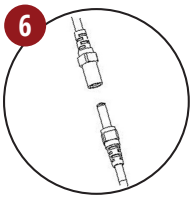

Connect single pin connector from Preheat Controller to Power Supply

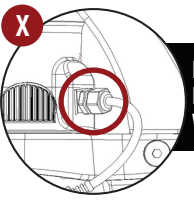

Flair 58 Only - The Preheat Controller is hard wired to the brew cylinder and cannot be removed

Using Your Preheat System (Flair 58 Only)



The Flair 58's Preheat Control System can preheat the brewing cylinder to three different temperatures: Low, Medium or High, which can be used for different roast and extraction levels.

Please find usage details for the Preheat Control System below and full safety instructions in our online **Safety and Instructions Guide**, which can be found online at: <https://flairespresso.com/flair-58-tutorials/>

TURN ON - Press & hold button (3 sec) - LEFT light will BLINK - then...		
LOW ~85° C (185° F)	MEDIUM ~90° C (194° F)	HIGH ~95° C (203° F)
Wait A Few Minutes (for preheat to complete)	Push Button AGAIN (CENTER light will BLINK)	Push Button 2 TIMES (RIGHT light will BLINK)
Left Light Will Become SOLID (when Low Temp is reached)	Wait A Few Minutes (for preheat to complete)	Wait A Few Minutes (for preheat to complete)
	LEFT & CENTER Lights Become SOLID (Med Temp is reached)	ALL Lights SOLID (when High Temp is reached)
TURN OFF - Press & hold button (3 sec) - ALL lights OFF		

Preheating without Electricity (Flair 58 & 58x)

(a) Raise lever & unlock and lift lever hook (b) Remove the brew head by turning clockwise with gauge in place (c) Add Open Preheat Cap onto bottom of brew head (d) Lift kettle top and replace with brewhead (e) Turn plunger stem counterclockwise until two tabs align with openings in plunger, leave in place to act as a release valve (f) Boil water to preheat

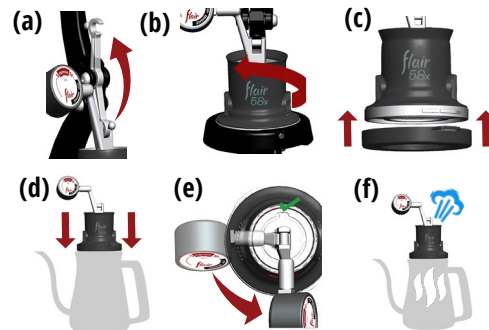

***NOTE:** If the brew head does not fit on your kettle, preheat your chamber with boiled water and the valve plunger lowered. Purge and repeat as necessary.

Two Ways to Fill the Brew Head

Each Flair 58 & 58x comes with a valve plunger which allows water to be added to the brew chamber without removing the plunger stem. But, there are times when the original method of filling the chamber, by removing the plunger stem, is preferred. Instructions for both processes are below:

Using the Valve Plunger Method

(a) Fill brew cylinder to rim with water (b) Raise lever enough to unseat stem and open valve allowing water to fill head space below (c) Continue to raise lever slowly, and water will pass through the valve and into the brewing chamber below (d) Top-off chamber through opening made between stem and plunger once lever reaches top

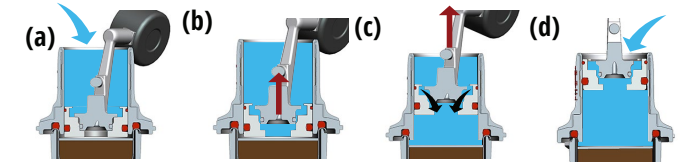

Using the Original Filling Method

The original method of filling the brew chamber is best for those that are using a lower dose than recommended for the portafilter basket, or those that have a boil point for water that is lower than 100 degrees C (this typically happens at higher altitudes). In both of these cases, it can be difficult to ensure there are no excess air pockets in the brew cylinder with the valve plunger. Using the original method solves this.

(a) Unlock and lift lever hook all the way up (b) then turn plunger stem counterclockwise until two tabs align with openings in plunger and remove stem by gently lifting (c) Pour brew water into cylinder until opening of the plunger is filled. Reinsert stem and lock back in by reversing order for removal (d) Connect lever to plunger stem by engaging the lever hook

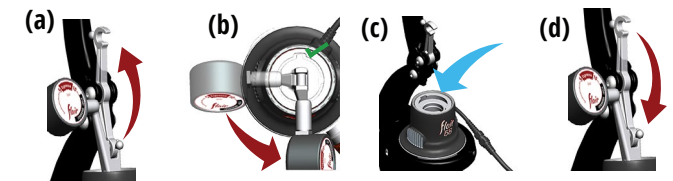

More information about filling methods can be found at:

<https://flairespresso.com/flair-58-tutorials/>