



THE BRAVE INSPIRE

General Catalogue
2022

_ Index

Sanremo	_02
—	
Coffee Machines	_04
Opera 2.0	_06
Café Racer	_16
F18	_26
F18 SB	_30
Verona RS	_34
Verona	_38
Napoli	_40
Torino	_42
Zoe Competition	_44
Zoe	_46
Cube	_48
You	_52
—	
Grinders	_56
On demand	_58
AllGround	_62

THE BRAVE INSPIRE

PIONEERS OF A NEW VISION



A broad vision. A horizon defined by a high and ambitious goal, to be contemplated and then achieved, to be admired and eventually conquered.

Be inspired, take a deep breath then go: start your adventure.

Because courage is not the absence of fear, but the ability to conquer it.



SANREMO
COFFEEMACHINES

made in italy

SANREMO, MORE THAN A COMPANY

A benchmark for innovation and excellence in espresso coffee machines production Made in Italy; an inspirational brand for coffee lovers who celebrate the art of coffee extraction.

This is Sanremo: A fusion of a strong production tradition and ambitious dreams. A winning combination that has given

the company international recognition and is now a point of reference in the coffee machine sector.

Our production department is second to none, our technological know-how, mixed with quality materials, workmanship and creativity.

An international research & development team, trained by the best in the coffee industry united with the same fighting spirit which Sanremo machines express.

Coffee Machines



Opera 2.0



Opera. The full story
Watch the video



Versions

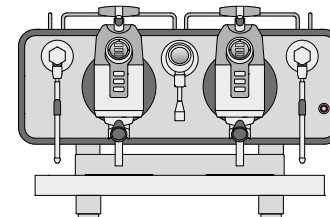

31" / 786 mm

2 group OP

- 2 steam taps
- 1 water tap
- 1 one-cup filter holder
- 2 two-cup filter holders

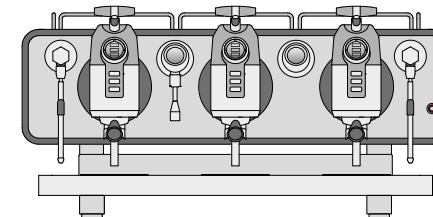

41" / 1040 mm

3 group OP

- 2 steam taps
- 1 water tap
- 1 one-cup filter holder
- 3 two-cup filter holders

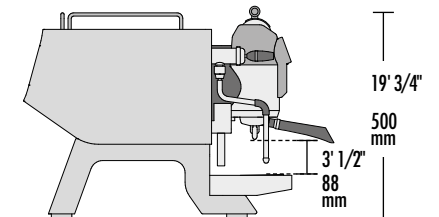

19' 3/4" / 507 mm

25' 2/3" / 653 mm

19' 3/4"

500 mm

3' 1/2"

88 mm



TALL VERSION

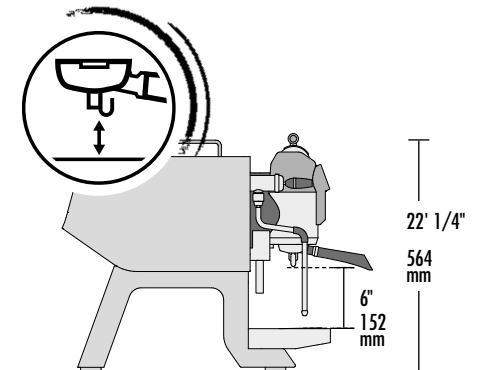

22' 1/4"

564 mm

6"

152 mm



Technical data

		2 group	3 group
voltage	V	220-240 1N / 380-415 3N	
max input boiler/steam boiler's resistor power	kW	7.7 / 3.5	8.3 / 3.5
		8.5 / 4.5	9.1 / 4.5
steam boiler services	lt	8	10
external pump power	kW	0.15	0.15
preheating boiler capacity	lt	2.8	2.8
preheating boiler resistance power	kW	1.5	1.5
cup-heater power	kW	0.20	0.25
units boiler capacity	lt	1.0	1.5
units boiler resistance power	kW	1.6	2.4
net weight	lb / kg	200 / 91	249 / 113
gross weight (with shipping crate)	lb / kg	308 / 140	375 / 170.5

MULTI-BOILER SYSTEM

High accuracy thermal stability thanks to the Sanremo multiboiler system with sophisticated electronic boards that continuously control temperature throughout all phases of extraction. Steam and coffee circuits work totally independent to maximize performance in every working condition (also under high workload).

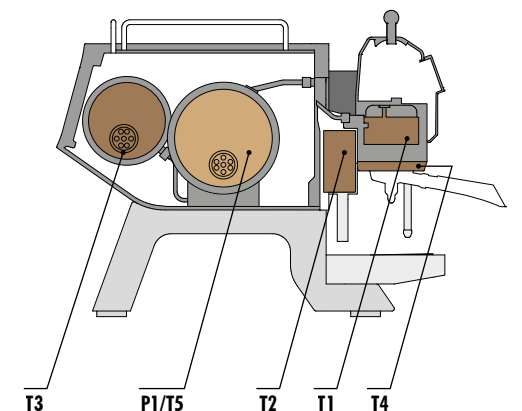

The Revolution

Be in control, express yourself

DOUBLE SELECTION BUTTONS

Easy-touch setting with 6 different profiles for individual groups

SMART LEVER

Coffee doses fast manual selection

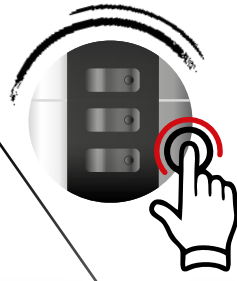
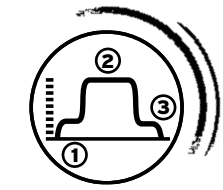

CDS SYSTEM

Maximum precision and full control on the three phases of coffee extraction



POWER DRY STEAM

Low additional liquid during the milk steaming

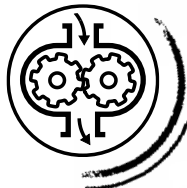

GEAR PUMP PERFORMANCE

High and constant pressure in all conditions

EVERYTHING UNDER CONTROL

System digital display to provide visibility of all working parameters



HEART OF STEEL

For maximum thermal stability:

- Groups in AISI 316L weight 22 lb / 10 kg each
- Filter holders AISI 316
- Boilers AISI 316

WI-FI CONNECTION



EASY APP

Tablet or smartphone barista's Webapp for setting parameters



Opera. The Revolution
Link to the website

Characteristics



AISI 316L STEEL GROUPS WITH 22 lb / 10 kg PURE STEEL
Exclusive Sanremo design ensure exceptional thermal stability and maximum resistance to oxidation and lime scale.



AISI 316 STAINLESS STEEL FILTER HOLDER WITH "COMPETITION FILTER"
Exclusive Sanremo design, with shape and volume designed to capture the best coffee aromas and fragrances.



AISI 316L STAINLESS STEEL FREE MOTION STEAM TAPS
Flexible control system for producing and dispensing steam.



AISI 316L STAINLESS STEEL STEAM WAND "COOL TOUCH"
Anti-burning feature even in conditions of prolonged use, fitted with "Latte Art" high-performance steam terminals.

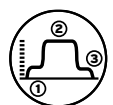

CONTROL COFFEE DELIVERY SYSTEM (CDS)
Three phases extraction parameters full control (pre-infusion, infusion, post-infusion).



INDEPENDENT ADJUSTMENT OF THE PID INFUSION WATER TEMPERATURE
Precision setting (gradient $\pm 0.1^\circ\text{C}$ with measured constancy lower than 0.2°C).



INFUSION WATER DISPLAY
Indicates tea and herbal teas water brewing temperature. (In the two group it is shown with the steam boiler display)



STEAM BOILER DISPLAY
Indicates steam boiler temperature and pressure. (In the two group Opera it is shown with the infusion water display)



COFFEE UNIT SINGLE DISPLAY
Controls of all coffee extraction parameters.



MACHINE'S PROGRAMMING PARAMETERS DISPLAY
The internal display is a handy programming interface for the maintenance technician.



MIXED INFUSION HOT WATER FOR TEA AND HERBAL TEAS
Instantaneous mixing of fresh water and steam for a better chemical and organoleptic quality.

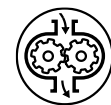

GEAR PUMPS
Dedicated to each individual group, allow to change the pressure during infusion.



STEAM CONTROL ADJUSTABLE ELECTRONIC PRESSURE SWITCH
Sensor with 0.02 bar precision that allows the chosen pressure and steam in the boiler to be kept constant in all conditions of use.



PROGRAMMABLE CUP WARMER TEMPERATURE
Allows the cups to be kept at the optimum temperature in the most different climatic conditions.



EASY SERVICE
Fast access to the internal parts for quick and easy technical service.



AUTO-DIAGNOSIS, STATISTICAL DATA, SCHEDULED MAINTENANCE
Maintenance can be scheduled according to litres or number of coffees dispensed.



AUTO-ON, AUTO-OFF AND DAY-OFF FUNCTION
Programmable on-off timer for each day and/or daily timetables.



AUTOMATIC CLEANING CYCLE
Process for coffee groups cleaning.



ENERGY SAVING SYSTEM
Component insulation and smart electronics for maximum energy efficiency.



GROUP FLUSHING
With a simple pressure of the button a small quantity of water is dispensed to allow the group to be always clean.

Optional



*** STAINLESS STEEL NAKED PORTAFILTERS**



TALL VERSION



ENHANCED RESISTANCE



**** HIGH POWER STEAMER TERMINAL (bigger holes diameter)**



EXTERNAL VOLUMETRIC PUMP

Standard models

wide range of models

OPERA 2.0
THE REVOLUTION



✓ **Opera Steel**
Standard back panel: |BP1|



✓ **Opera Black**
Standard back panel: |BP5|



Choose the panel

to suit your style



BP1 Etched crystal / backlight



BP2 Painted wood



BP5 Black / backlight



Back panel of each version can be customized, with finishes that complement your style and needs.



✓ **Opera White**
Standard back panel: |BP2|



Everything in an App

app dedicated to parameter settings for tablet

(step A) GROUP SELECTION

(step B) PUSH / PULL LEVER SELECTIONS OF BUTTONS

(step C) SELECTIONS OF PROFILE BUTTONS PUSH / dose 1,2,3 PULL / dose 4,5,6

(step D) TEMPERATURE REGULATION

(step E) DOSE REGULATION

(step F) INFUSION REGULATION

With the interface "Express yourself", the barista has total control of the extraction phase of his coffee and can manage each dispensing parameter according to his experience and professionalism.

To configure and set all the parameters of the machine, a specific App has been designed, which runs on tablet.

The application "Express yourself" utilizes a graphic interface, it is both user friendly and intuitive. This interface allows the user to set each groups relative parameters accurately for the perfect extraction.

Upon choosing the group (step A) and assigned a configured profile (step B,C) will define the general parameters of extraction: temperature and doses (step D,E). At the end it is possible to adjust the parameters relative of the 3 extraction's phases: pre-infusion, main infusion, post-infusion (step F).

For each group it is possible to set:

Temperature

- water temperature T2
- group temperature T3
- steam temperature T5 (unique boiler for all groups)

Dose

- weight of ground coffee
- water dose
- pump pressure
- coffee weight

Infusion

- timing
- pump pressure
- amount of water

PRE-INFUSION

INFUSION

POST-INFUSION

(step F) Adjust the 3 extractions phases

This operation is simplified by the App. Everytime the user modify one of these parameter the software update automatically. What was set prior to the modification.



CONFIGURATIONS

- STANDARD
- STRONG
- BALANCED
- SWEET & LIGHT
- ... N (set by the user)
- ... N (set by the user)

It is possible to save and recall new configurations set by the user or the default ones, specifically designed to allow even the less experienced bartenders to obtain immediately excellent results in the cup.

Clicking in "save new configuration" you can save your perfect espresso dispensing menu and transfer it into another machine.

Opera wi-fi

simplify things



14 From today the Opera 2.0 is easier to handle, thanks to the *Sanremo Cloud* and *Webapp Expressyourself* interface, for an even easier and interactive using experience.

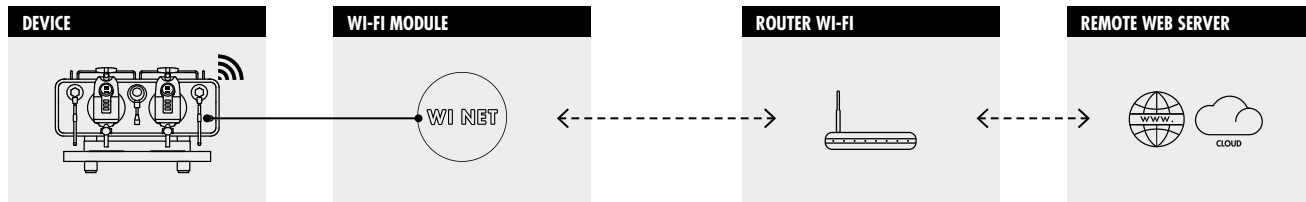

- Handling through Sanremo app, from smartphone, tablet, or pc, of all configuration parameters of the machine, without the need for physically being in front of it.
- Possibility of connecting multiple machines simultaneously for sharing, modifying, and setting of recipes and configurations.
- Simultaneous monitoring and handling of multiple machines by the same owner (e.g.: franchising in different locations).
- Statistical analysis of consumption, distribution, maintenance, configuration for all connected machines.
- Remote maintenance by the technician for updating, verification of the correct settings and parameters control.

INTRANET (WI-FI LOCAL NET)

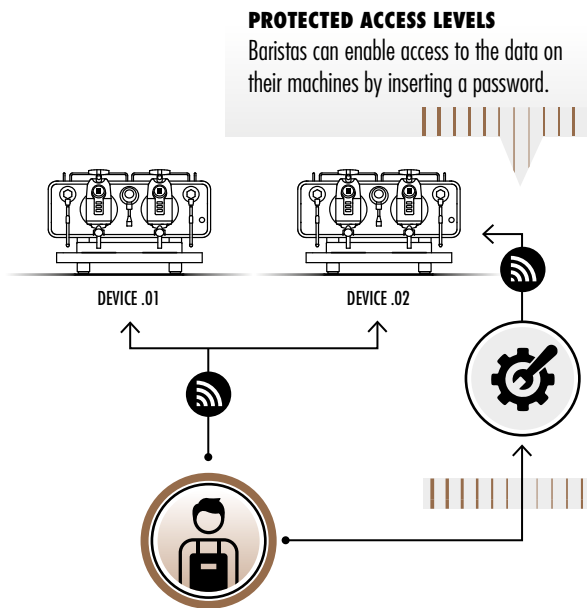

PROTECTED ACCESS LEVELS
Baristas can enable access to the data on their machines by inserting a password.

- PLUS + (USING THE LOCAL WI-FI NETWORK)**
- _ Reading and changing machine settings and parameters
 - _ Consumptions analysis for a better stock management
 - _ Meters reading of the coffee dispensed
 - _ Saving, restoring and sharing of settings (recipes) on your machines

Data exchange can only be effective in the wi-fi range.

INTERNET (GLOBAL NET) / SANREMO CLOUD

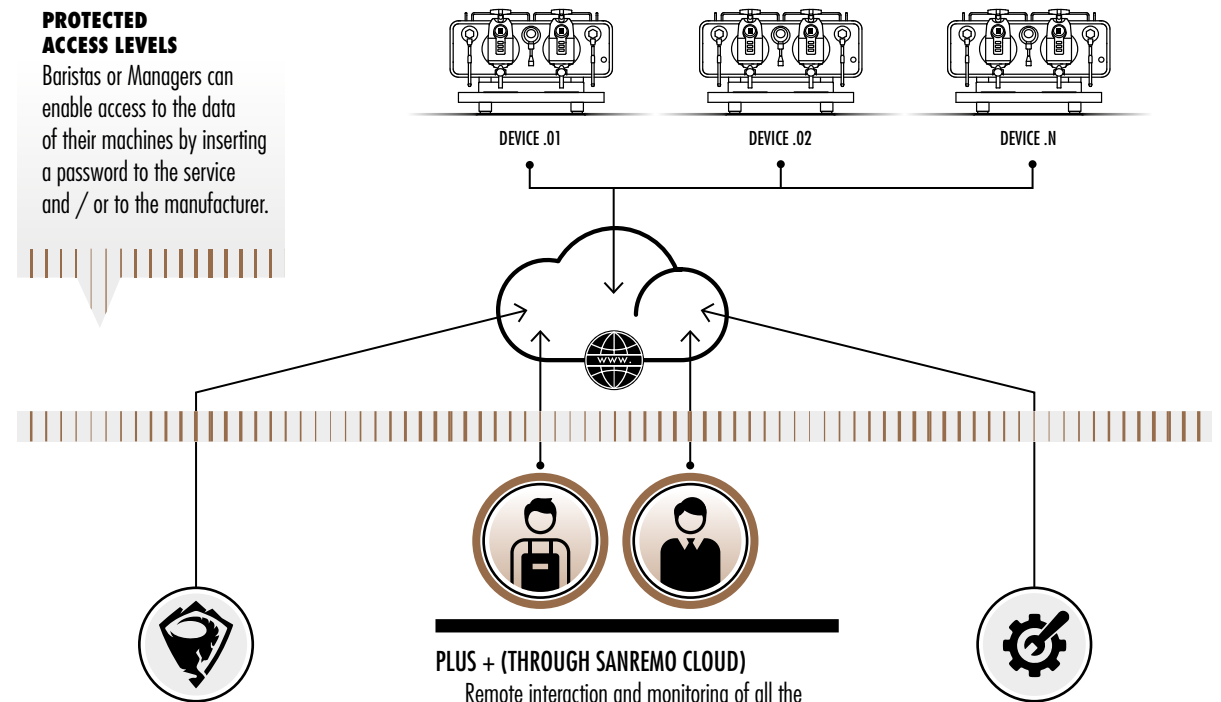

PROTECTED ACCESS LEVELS
Baristas or Managers can enable access to the data of their machines by inserting a password to the service and / or to the manufacturer.

- PLUS + (ENABLING THE MANUFACTURER)**
- _ Sending of App updates to the machines
 - _ Sending new settings (recipes)
 - _ Clearer and faster data collection aimed to resolve any technical/constructive problems
 - _ Useful information for the improvement and evolution of the product
 - _ Direct and continuous contact with the manufacturer

- PLUS + (THROUGH SANREMO CLOUD)**
- _ Remote interaction and monitoring of all the functions and performances of the machine
 - _ Reading and changing of the machine settings
 - _ Display of historical usage data
 - _ Consumptions analysis for a better stock management
 - _ Meters reading of the coffee dispensed
 - _ Saving, restoring and sharing of settings (recipes) on your machines

- PLUS + (ENABLING THE SERVICE)**
- _ Immediate report of anomalies
 - _ Diagnosis and possible remote troubleshooting
 - _ Reduction of machine downtime
 - _ Logistic planning and organization of maintenance interventions

- BARISTA**
- MANAGER**
- MAINTENANCE SERVICE**
- MANUFACTURER**
- SANREMO CLOUD**
- INTERNET GLOBAL NETWORK**
- LOCAL WI-FI NETWORK**

Café Racer



TECEX RoHS

Versions

17

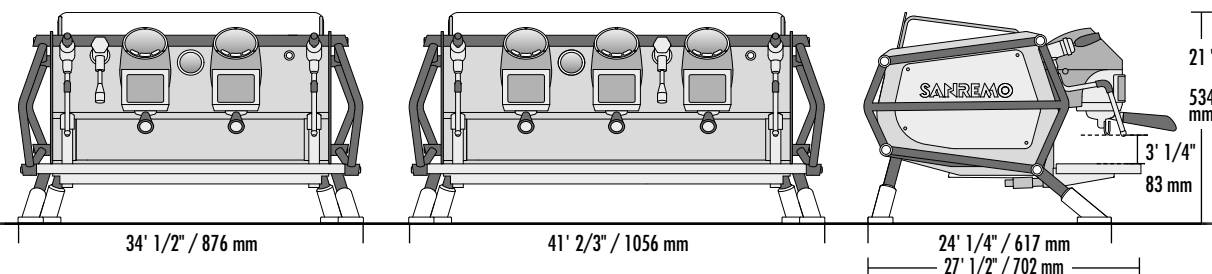

2 group CR
 2 steam taps
 1 water tap
 1 one-cup filter holder
 2 two-cup filter holders

3 group CR
 2 steam taps
 1 water tap
 1 one-cup filter holder
 3 two-cup filter holders



CE

Technical data		2 group	3 group
voltage	V	220-240 1N / 380-415 3N	
max input boiler/steam boiler's resistor power	kW	6.9 / 3.5	8.1 / 3.5
		8.1 / 4.5	8.4 / 4.5
steam boiler capacity	lt	8	10
external pump power	kW	0.160	0.160
preheating boiler capacity	lt	1.0	1.5
preheating boiler resistance power	kW	1.0	1.5
cup-heater power	kW	0.16	0.20
units boiler capacity	lt	1.0	1.5
units boiler resistance power	kW	1.6	2.4
net weight	lb / kg	214 / 97	265 / 120
gross weight (with shipping crate)	lb / kg	333 / 151	388 / 176

MULTIBOILER SYSTEM

Sanremo Café Racer multiboiler system ensures a new level of thermal precision thanks to the 4 points of temperature PID control.

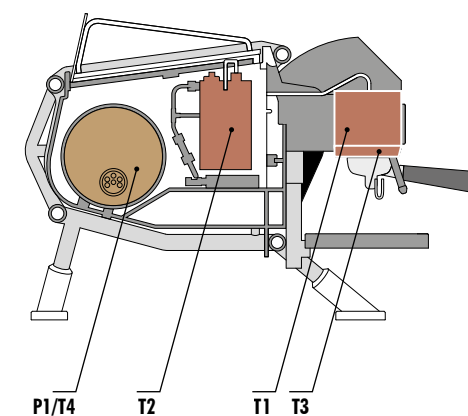

Take a ride, explore it's soul



ENERGY SAVING SYSTEM
Component insulation and smart electronics for maximum energy efficiency



VOLUMETRIC PUMP PERFORMANCE
The unique 300 l/h pump guarantees constant pressure in all conditions of machine use

HIGH PERFORMANCE FLOWMETER VOLUMETRICS

For an accurate and precise coffee dose in the cup



POWER DRY STEAM
Low additional liquid during the milk steaming



EASY SERVICE
Fast access to the internal parts for quick and easy technical service



Smart-touch setting of the individual groups

EVERYTHING UNDER CONTROL

System digital display to provide visibility of all working parameters



HEART OF STEEL

For maximum thermal stability:
• Groups in AISI 316L, weight 17.6 lb / 8 kg each
• Portafilters AISI 31
• Boilers AISI 316



ADJUSTABLE HEIGHT WORK SURFACE

Innovative Sanremo "All in one" suspension system that allows cups of different shapes and heights (adjustable from 3' 2/4" to 5' 3/4" / from 85 to 150 mm)



SOFT PRE-INFUSION



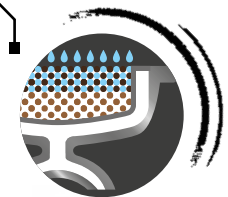

Flowactive System: for precise control of the water flow and pre-infusion time







 **Café Racer, born to run**
Link to the website





Characteristics





-  **AISI 316L STEEL GROUPS WITH 17.6 lb / 8 kg PURE STEEL**
Exclusive Sanremo design ensure exceptional thermal stability and maximum resistance to oxidation and lime scale.
-  **AISI 316 STAINLESS STEEL FILTER HOLDER WITH "COMPETITION FILTER"**
Exclusive Sanremo design, with shape and volume designed to capture the best coffee aromas and fragrances.
-  **AISI 316L STAINLESS STEEL FREE MOTION STEAM TAPS**
Flexible control system for producing and dispensing steam.

-  **AISI 316L STAINLESS STEEL STEAM WAND "COOL TOUCH"**
Anti-burning feature even in conditions of prolonged use, fitted with "Latte Art" high-performance steam terminals.
-  **PROGRAMMABLE ELECTRONIC PRE-INFUSION**
Allows control with 0.1 second tolerance of the flow of water that wets the coffee bed, with programming of 4 different profiles for each group.
-  **INDEPENDENT ADJUSTMENT OF THE PID INFUSION WATER TEMPERATURE**
Precision setting (gradient ± 0.5 °C with measured constancy lower than 0.2°C).
-  **SYSTEM DISPLAY**
Visibility of all the machine functions: temperatures, pressures and levels.

-  **COFFEE UNIT SINGLE DISPLAY**
Control of all coffee extraction parameters.
-  **MIXED INFUSION HOT WATER FOR TEA AND HERBAL TEAS**
Instantaneous mixing of fresh water and steam for a better chemical and organoleptic quality.
-  **HIGH PERFORMANCE VOLUMETRIC PUMP 300 l/h**
Pressure stability also with prolonged and contemporary use of more than one group.
-  **HIGH PERFORMANCE FLOWMETER VOLUMETRICS**
For an accurate and precise coffee dose in the cup.

-  **STEAM CONTROL ADJUSTABLE ELECTRONIC PRESSURE SWITCH**
Sensor with 0.02 bar precision that allows the chosen pressure and steam in the boiler to be kept constant in all conditions of use.
-  **PROGRAMMABLE CUP WARMER TEMPERATURE**
Allows the cups to be kept at the optimum temperature in the most different climatic conditions.
-  **ELECTRONIC AUTO-LEVEL**
Through an electronic level probe the boiler is automatically filled and maintained to the right filling level.
-  **LED LIGHTING OF THE WORK AREA**
Allows efficient working in any condition of environmental lighting.

-  **AUTO-DIAGNOSIS, STATISTICAL DATA, SCHEDULED MAINTENANCE**
Maintenance can be scheduled according to litres or number of coffees dispensed.
-  **AUTO-ON, AUTO-OFF AND DAY-OFF FUNCTION**
Programmable on-off timer for each day and/or daily timetables.
-  **AUTOMATIC CLEANING CYCLE**
Process for coffee groups cleaning.
-  **BOILER WATER REGENERATION**
Ensures resetting of the optimum chemical characteristics of the water and correct mineralisation.

-  **GROUP FLUSHING**
With a simple pressure of the button a small quantity of water is dispensed to allow the group to be always clean.
- Other**
 -  **STAINLESS STEEL NAKED FILTER HOLDERS**
 -  **HIGH POWER STEAMER TERMINAL**
(bigger holes diameter)
 -  **EXTERNAL VOLUMETRIC PUMP**
 -  **ENHANCED RESISTANCE**

NAKED

✓ Transparent side and back panels

Available in 2 finishes:
black and steel, 
both available with some components*
in black or red.

● ●
* rings, bolts, feet, boiler insulation



FREEDOM

✓ Coloured side and back panels with the rear-lit logo

Available in 2 finishes:
black and steel, 
both available with some components*
in black or red.

● ●
* rings, bolts, feet



P1



P2



P3



P4



CUSTOM

Welcome to the Custom world of the Cafe Racer, huge creative potential and expression through customization. Some versions have become real icons. Chose your style and create your own unique Cafer Racer.

Renegade



handmade finishes [

-  Dark green
-  Oxidized copper
-  Brown leather
-  Polished brass
-  Oxidized brass

Dolomiti



hand-sewn

-  Matt black
-  Black steel
-  Black leather
-  Stainless steel



_ White & Wood Standard

_ CUSTOM

22

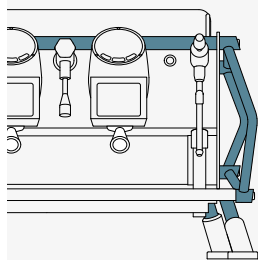

-  **Matt white**
-  **Natural oak**
-  **Stainless steel**
-  **Natural oak**

_ White & Wood Slim

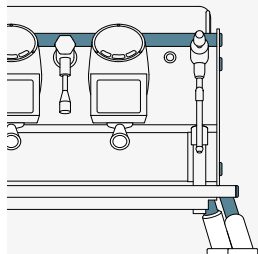

_ Racing

_ CUSTOM

23



-  **Gloss red**
-  **Matt white**
-  **Carbon**
-  **Stainless steel**

_ Moto di Ferro



-  **Matt black**
-  **Satinized aluminum**
-  **Stainless steel**
-  **Black**



_ Black & White

_ CUSTOM



_ Full White



Specialty
Coffee
Association

CERTIFIED
ESPRESSO MACHINE



F18



TECEx RoHS

Versions

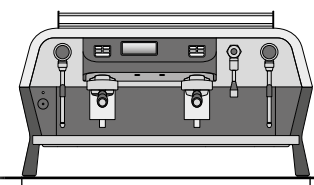

35' 1/2" / 901 mm

- 2 group**
- 2 steam taps
 - 1 water tap
 - 1 one-cup filter holder
 - 2 two-cup filter holders

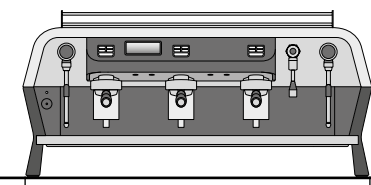

42' 1/4" / 1071 mm

- 3 group**
- 2 steam taps
 - 1 water tap
 - 1 one-cup filter holder
 - 3 two-cup filter holders

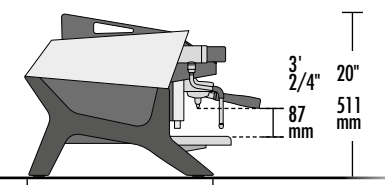

3' 2/4" 20"
87 mm 511 mm

23' 1/4" / 589 mm
25' 1/2" / 647 mm

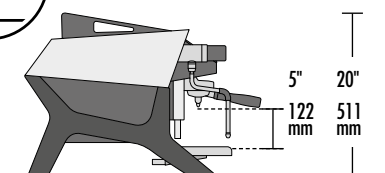
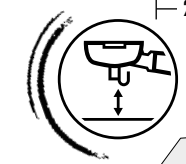

5" 20"
122 mm 511 mm



TALL VERSION

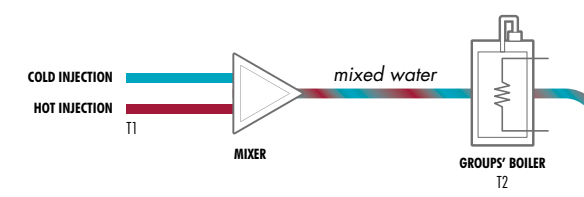

MULTIBOILER SYSTEM

Each group has a dedicated boiler powered by preheated water thanks to the mixing of cold and hot water coming from the heat exchangers; the group is kept at the ideal temperature by a specific resistor, which ensure a perfect thermal regulation.



Technical data		2 group	3 group
voltage	V	220-240 1N	380-415 3N
max input boiler/steam boiler's resistor power	kW	5.4 / 3.5	6.1 / 3.5
		6.3 / 4.5	7.2 / 4.5
steam boiler capacity	lt	8.6	10
pump power	kW	0.15	0.15
boiler capacity	lt	1	1.5
boiler element power	kW	1	1.5
cup-heater power	kW	0.20	0.25
net weight	lb / kg	182 / 82.5	222.5 / 101
gross weight (with shipping crate)	lb / kg	241.5 / 109.5	278 / 126

Colours

	Matte black	RAL 9005
	White Matte black	RAL 9003 9005
	Blue Matte black	RAL 5024 9005

In flight stability

Ready to take off



QUICK STEAM COUPLING
The new half-turn knob allows extreme precision limiting physical stress

REALTIME STABILITY GROUP

Exclusive Sanremo design that allows an accurate maintenance of the set temperature



REALTIME STABILITY

Constancy in the electronic controlled temperature ($\pm 0.2^\circ\text{C}$)



ENERGY SAVING SYSTEM
Component insulation and smart electronics for maximum energy efficiency



STAINLESS STEEL "COLD TOUCH"
Anti-burning feature fitted with "Latte Art" high-performance steam terminals



OPERATION ALARM MANAGEMENT

Dedicated menu for malfunction and alarm records

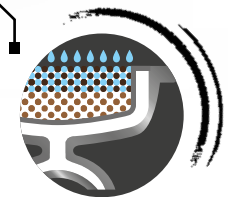

SOFT PRE-INFUSION
Flowactive System: for precise control of the water flow and pre-infusion time

Control panel:

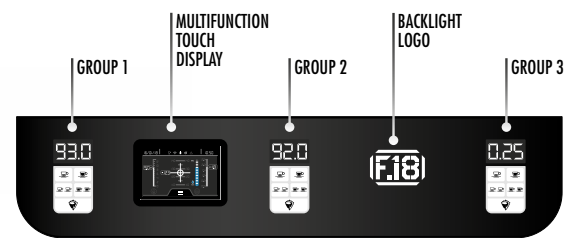

Keyboard 5 selections standard



Keyboard 7 selections optional



MULTIFUNCTION TOUCH DISPLAY

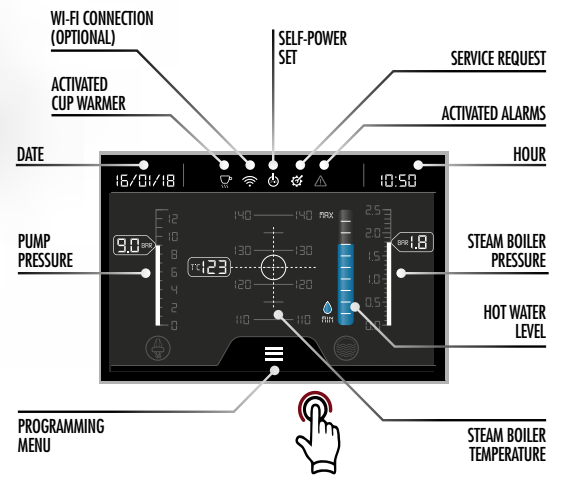

Characteristics

- MIXED INFUSION HOT WATER FOR TEA AND HERBAL TEAS**
Immediate mixing of cold / hot water for a better chemical and organoleptic quality.
- STATIC RELAY BOILER TEMPERATURE**
Allows to regulate the temperature as accurately as possible.
- STAINLESS STEEL COFFEE BOILER**
Guarantees excellent stability and thermal precision, associated with resistance to oxidation and limestone.
- INDEPENDENT REGULATION TEMPERATURE WATER COFFEE**
Maximum temperature precision and constancy of distribution.
- PROGRAMMABLE ELECTRONIC PRE-INFUSION**
Allows control with 0.1 second tolerance of the flow of water that wets the coffee bed, with programming of 4 different profiles for each group.
- AISI 316L STAINLESS STEEL STEAM WAND "COLD TOUCH"**
Anti-burning feature even in conditions of prolonged use, fitted with "Latte Art" high-performance steam terminals.
- PROGRAMMABLE CUP WARMER TEMPERATURE**
Allows the cups to be kept at the optimum temperature in the most different climatic conditions.
- LED LIGHTING OF THE WORK AREA**
Allows efficient working in any condition of environmental lighting.
- AUTO-ON, AUTO-OFF AND DAY-OFF FUNCTION**
Programmable on-off timer for each day and/or daily timetables.
- ENERGY SAVING SYSTEM**
Component insulation and smart electronics for maximum energy efficiency.
- REALTIME STABILITY GROUP**
Exclusive Sanremo design that allows a precise maintenance of the set temperature.

- EASY SERVICE**
Fast access to the internal parts for quick and easy technical service.
- AUTOMATIC CLEANING CYCLE**
Process for coffee groups cleaning.
- HIGH PERFORMANCE VOLUMETRIC PUMP**
Pressure stability also with prolonged and contemporary use of more than one group.
- COMPETITION FILTERS**
Exclusive Sanremo design, with shape and volume designed to capture the best coffee aromas and fragrances.
- TEMPCONTROL**
For a very-high thermal stability ($\pm 0.2^\circ\text{C}$).
- GROUP FLUSHING**
With a simple pressure of the button a small quantity of water is dispensed to allow the group to be always clean.
- Other**
- AUTOSTEAMER**
Steam wand characterized by an electronic system that allows the chosen pressure and steam in the boiler to be kept constant at the set temperature.
- EXTERNAL VOLUMETRIC PUMP**
- HIGH POWER STEAMER TERMINAL**
(bigger holes diameter)
- STAINLESS FILTER HOLDERS**
- STEAM CONTROL ADJUSTABLE ELECTRONIC PRESSURE SWITCH**
Sensor with 0.02 bar precision that allows the chosen pressure and steam in the boiler to be kept constant in all conditions of use.

F18 SB



Versions

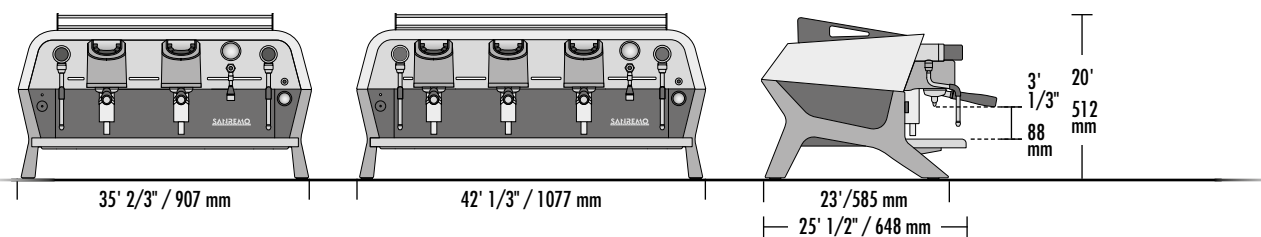

2 group

- 2 steam taps
- 1 water tap
- 1 one-cup filter holder
- 2 two-cup filter holders

3 group

- 2 steam taps
- 1 water tap
- 1 one-cup filter holder
- 3 two-cup filter holders

✓ "TALL" VERSION

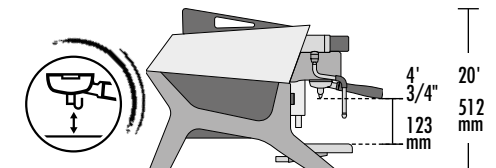

Colours

	Matte black Matte black	RAL 9004
	Matte black Matte white	RAL 9004 9003
	Matte black Brown	RAL 9004 8019
	Matte black Racing Red	RAL 9004 INVER 81784



Technical data

		2 group	3 group
voltage	V	220-240 1N / 380-415 3N	50/60Hz
max input boiler/steam boiler's resistor power	kW	3.2 / 2.7	5.65 / 5.1
		4.3 / 4.0	6.30 / 6.0
		5.0 / 4.5	
steam boiler capacity	lt	12	18
pump power	kW	0.15	0.15
cup-heater power	kW	0.20	0.25
net weight	lb / kg	172 / 78	211.5 / 96
gross weight (with shipping crate)	lb / kg	231.5 / 105	267 / 121

Control panel (4 or 6 PROGRAMMABLE DOSES)

Keyboard 5 selections

SHOT CLOCK
coffee extraction time

DOSES (1, 2)
SINGLE/DOUBLE

DOSES (3, 4)
SINGLE/DOUBLE

Keyboard 7 selections

CONTINUOUS DELIVERY
GROUP FLUSHING

DOSE (5) SINGLE

DOSE (6) DOUBLE

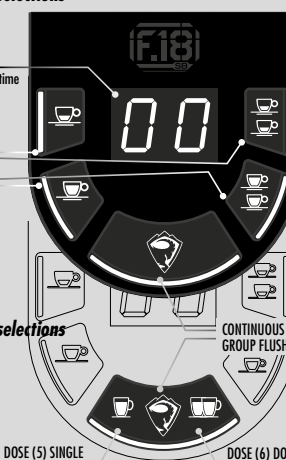



ENERGY SAVING SYSTEM

Component insulation and smart electronics for maximum energy efficient



DIE-CAST ALUMINIUM LEGS

Machine support made in die-cast aluminium

GROUP SR 61

Chromed brass grouphead with thermosiphonic circulation system optimized to maintain the ideal coffee extraction temperature

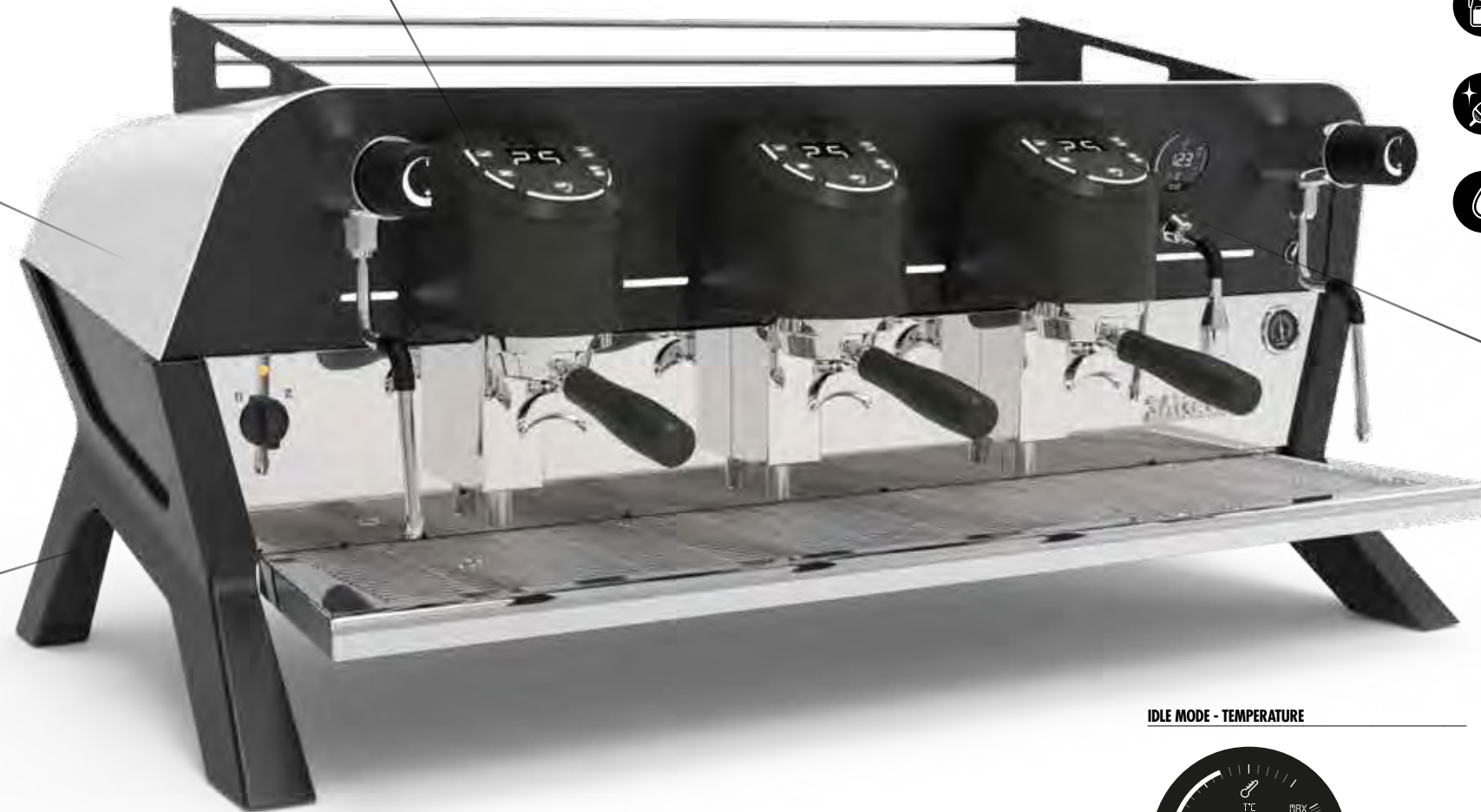

AUTOSTEAMER

- FOAMING
- STEAMING
- AUTOMATIC CLEANING
- HOT WATER



Autosteamer Version

MULTIFUNCTION DISPLAY

ECO MODE



IDLE MODE - TEMPERATURE

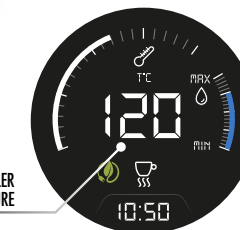

FUNCTIONS



F18 SB
Link to the website

Characteristics

- DIE-CAST ALUMINIUM LEGS**
- PRESSURE GAUGE**
Allows to monitor the inlet and pump pressure during extraction.
- ELECTRONIC AUTO-LEVEL**
Through an electronic level probe the boiler is automatically filled and maintained to the right filling level.
- STATIC RELAY BOILER TEMPERATURE**
Allows to regulate the temperature as accurately as possible thanks to the PID algorithm.
- MULTIFUNCTION DISPLAY**
Allows to monitor the right functioning of the machine and to program the main functions.
- PROGRAMMABLE ELECTRONIC PRE-INFUSION**
Allows control with 0.1 second tolerance of the flow of water that wets the coffee bed, with programming of 4 different profiles for each group.
- HIGH PERFORMANCE VOLUMETRIC PUMP**
Pressure stability also with prolonged and contemporary use of more than one group.
- GROUP FLUSHING**
With a simple pressure of the button a small quantity of water is dispensed to allow the group to be always clean.
- GROUP SR 61**
Chromed brass grouphead with thermosiphonic circulation system optimized to maintain the ideal coffee extraction temperature.
- CUP WARMER**
Dedicated resistor to keep all the cups at the optimal temperature. Power level programmable by user.
- AUTOMATIC CLEANING CYCLE**
Process for coffee groups cleaning. Cleaning cycles number programmable.

- ENERGY SAVING SYSTEM**
Component insulation and smart electronics for maximum energy efficiency.
- MIXED INFUSION HOT WATER FOR TEA AND HERBAL TEAS**
Immediate mixing of cold / hot water for a better chemical and organoleptic quality.
- AUTO-ON, AUTO-OFF AND DAY-OFF FUNCTION**
Programmable ON-OFF/ON-ECO timer for each day and/or daily timetables.
- EASY SERVICE**
Fast access to the internal parts for quick and easy technical service.
- Other**
- AUTOSTEAMER**
Steam wand characterized by an electronic system which allows to froth milk and heat up beverages at a programmable temperature, different for every single function. Automatic cleaning cycle is included.
- EXTERNAL VOLUMETRIC PUMP**
- COMPETITION FILTERS**
Exclusive Sanremo design, with shape and volume designed to capture the best coffee aromas and fragrances.
- AISI 316L STAINLESS STEEL STEAM WAND "COLD TOUCH"**
Anti-burning feature even in conditions of prolonged use, fitted with "Latte Art" high-performance steam terminals.
- NAKED FILTER HOLDERS**
- PAYMENT SYSTEM**
RS-232 communication protocol to manage cash register systems.
- LED LIGHTING OF THE WORK AREA**
Allows efficient working in any condition of environmental lighting.
- ENHANCED RESISTANCE**

Verona RS



Versions

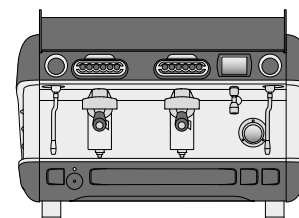

32' 1/4" / 818 mm

- 2 group RS**
- 2 steam taps
 - 1 water tap
 - 1 one-cup filter holder
 - 2 two-cup filter holders

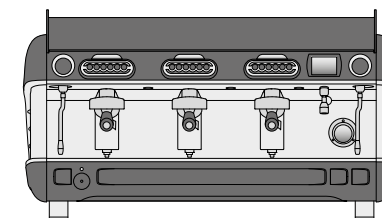

41' 1/4" / 1048 mm

- 3 group RS**
- 2 steam taps
 - 1 water tap
 - 1 one-cup filter holder
 - 3 two-cup filter holders

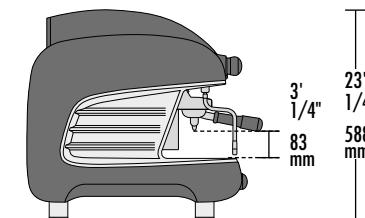

18' / 459 mm

23' 1/2" / 599 mm

3' 1/4" / 83 mm

23' 1/4" / 588 mm

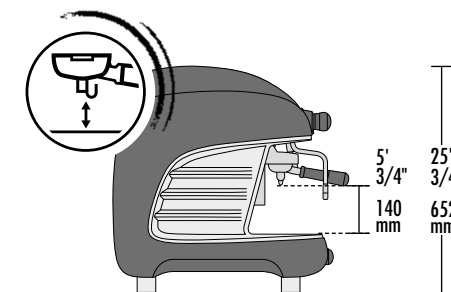

TALL VERSION

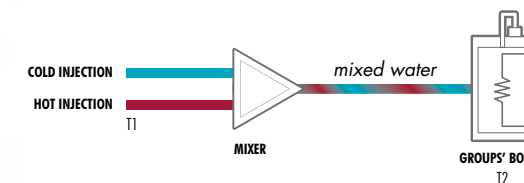

MULTIBOILER SYSTEM

Each group has a dedicated boiler powered by preheated water thanks to the mixing of cold and hot water coming from the heat exchangers; the group is kept at the ideal temperature by a specific resistor, which ensure a perfect thermal regulation.



Technical data		2 group	3 group
voltage	V	220-240 1N / 380-415 3N	
max input boiler/steam boiler's resistor power	kW	5.3 / 3.5	6.0 / 3.5
steam boiler capacity	lt	8.6	10
pump power	kW	0.2	0.2
RS boiler capacity	lt	1	1.5
RS boiler element power	kW	1	1.5
cup-heater power	kW	0.20	0.25
net weight	lb / kg	150 / 68	187 / 85
gross weight (with shipping crate)	lb / kg	163 / 74	200 / 91

Colours

	Black	RAL 9005
	White	RAL 1013
	Red	RAL 3011



RS GROUP
Exclusive Sanremo design that allows an accurate maintenance of the set temperature

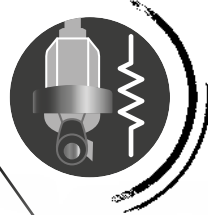

Realtime Stability

A sprint of technology

Single group display:

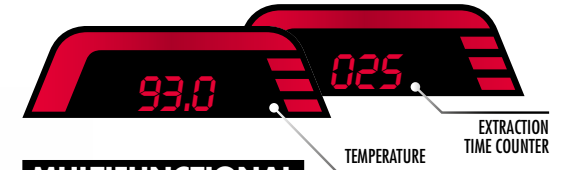

MULTIFUNCTIONAL DISPLAY

Touch display:

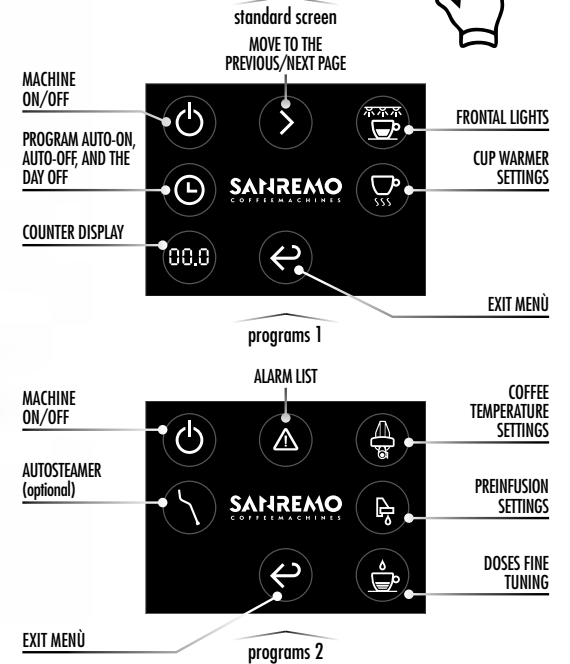
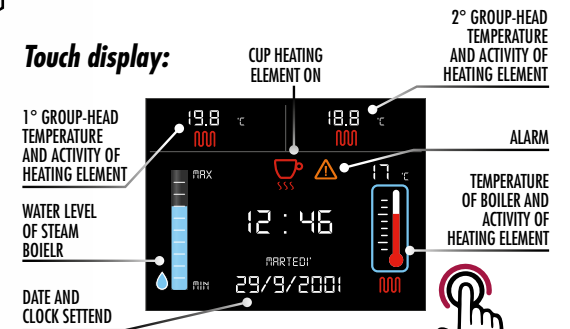

REALTIME STABILITY

Constancy in the electronic controlled temperature ($\pm 0.2\text{ }^{\circ}\text{C}$)



PRE-INFUSION SYSTEM

Enabled pre-infusion start&stop for each group



STAINLESS STEEL "COLD TOUCH"

Anti-burning feature fitted with "Latte Art" high-performance steam terminals



Verona RS
Link to the website



ENERGY SAVING SYSTEM

Component insulation and smart electronics for maximum energy efficiency

Characteristics

- MIXED INFUSION HOT WATER FOR TEA AND HERBAL TEAS**
Immediate mixing of cold / hot water for a better chemical and organoleptic quality.
- ELECTRONIC AUTO-LEVEL**
Through an electronic level probe the boiler is automatically filled and maintained to the right filling level.
- STATIC RELAY BOILER TEMPERATURE**
Allows to regulate the temperature as accurately as possible.
- STAINLESS STEEL COFFEE BOILER**
Guarantees excellent stability and thermal precision, associated with resistance to oxidation and limestone.
- INDEPENDENT REGULATION TEMPERATURE WATER COFFEE**
Maximum temperature precision and constancy of distribution.
- PRE-INFUSION SYSTEM**
Enabled pre-infusion start&stop for each group.
- AISI 316L STAINLESS STEEL STEAM WAND "COOL TOUCH"**
Anti-burning feature even in conditions of prolonged use, fitted with "Latte Art" high-performance steam terminals.
- PROGRAMMABLE CUP WARMER POWER**
Electronic programmable cup warmer to keep cups warmed at the right temperature.
- LED LIGHTING OF THE WORK AREA**
Allows efficient working in any condition of environmental lighting.
- AUTO-ON, AUTO-OFF AND DAY-OFF FUNCTION**
Programmable on-off timer for each day and/or daily timetables.
- DOUBLE READING GAUGE**
Allows to control at the same time the boiler pressure and the distribution pressure.

- ENERGY SAVING SYSTEM**
Component insulation and smart electronics for maximum energy efficiency.
- RS GROUP**
Exclusive Sanremo design that allows a precise maintenance of the set temperature.
- EASY SERVICE**
Fast access to the internal parts for quick and easy technical service.
- CLEANING CYCLE**
Process for coffee groups cleaning.
- HIGH PERFORMANCE VOLUMETRIC PUMP**
Pressure stability also with prolonged and contemporary use of more than one group.
- COMPETITION FILTERS**
Exclusive Sanremo design, with shape and volume designed to capture the best coffee aromas and fragrances.
- TEMPCONTROL**
For a very-high thermal stability ($\pm 0.2\text{ }^{\circ}\text{C}$).
- GROUP FLUSHING**
With a simple pressure of the button a small quantity of water is dispensed to allow the group to be always clean.

- Other**
- AUTOSTEAMER**
Steam wand characterized by an electronic system that allows to mount and/or heat milk at the set temperature.
 - EXTERNAL VOLUMETRIC PUMP**
 - HIGH POWER STEAMER TERMINAL (bigger holes diameter)**
 - STAINLESS FILTER HODERS**
 - ENHANCED RESISTANCE**

Verona



124 C° 10:00
SANREMO

TIME AND TEMPERATURE DISPLAY

only mod. SED



SED VERSION

Guarantees an electronic dosing system through the button panel



SAP VERSION

Allows the semi-automatic programming of doses

GROUP SR 61

Optimized to maintain the ideal coffee extraction temperature

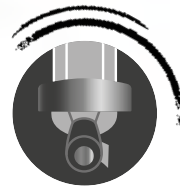

Verona
Link to the website

Characteristics



ELECTRONIC AUTO-LEVEL
Through an electronic level probe the boiler is automatically filled and maintained to the right filling level.



ACTIVATED ELECTRONIC PRE-INFUSION
Management of the delayed activation of water solenoid in the first phase of brewing.



EASY SERVICE
Fast access to the internal parts for quick and easy technical service.

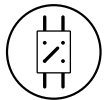

STATIC RELAY BOILER TEMPERATURE
Allows to regulate the temperature as accurately as possible.



MULTIFUNCTION DISPLAY
Allows to monitor the right functioning of the machine and to program the main functions.



AUTOMATIC CLEANING CYCLE
Process for coffee groups cleaning.



DOUBLE READING GAUGE
Allows to control at the same time the boiler pressure and the distribution pressure.



GROUP SR 61
Chromed brass grouphead with thermosiphonic circulation system optimized to maintain the ideal coffee extraction temperature.

Colours

	Red	RAL 3002
	Matte black	RAL 9005
	Black	RAL 9005
	Silver	RAL 9006
	Pearl white	RAL 1013
	White	RAL 9003



Versions

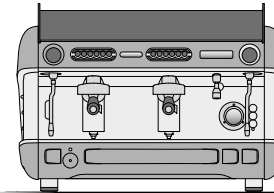

32' 2/4" / 820 mm

2 group SED/SAP

- 2 steam taps
- 1 water tap
- 1 one-cup filter holder
- 2 two-cup filter holders

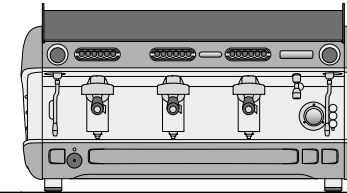

41' 2/4" / 1050 mm

3 group SED/SAP

- 2 steam taps
- 1 water tap
- 1 one-cup filter holder
- 3 two-cup filter holders

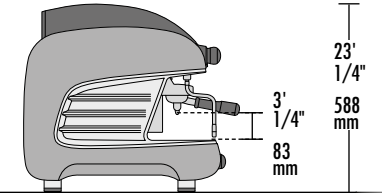

18' / 459 mm
23' 1/2" / 599 mm

23' 1/4" / 588 mm

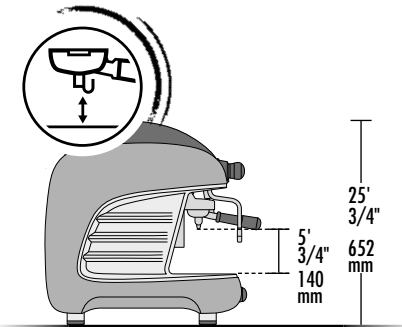

TALL VERSION

Other



AUTOSTEAMER
Steam wand characterized by an electronic system that allows to mount and/or heat milk at the set temperature.



COMPETITION FILTERS
Exclusive Sanremo design, with shape and volume designed to capture the best coffee aromas and fragrances.



EXTERNAL VOLUMETRIC PUMP



MIXED INFUSION HOT WATER FOR TEA AND HERBAL TEAS
Immediate mixing of cold / hot water for a better chemical and organoleptic quality.

Technical data

		2 group	3 group
voltage	V	220-240 1N / 380-415 3N	
max input boiler/steam boiler's resistor power	kW	3.15 / 2.7	5.35 / 5.1
		5.1 / 4.5	
steam boiler capacity	lt	12.7	19
pump power	kW	0.15	0.15
net weight	lb / kg	150 / 68	187 / 85
gross weight (with shipping crate)	lb / kg	161 / 73	201 / 91

*4 group machine available upon request



CUP WARMER
Dedicated resistor to keep all the cups at the optimal temperature.



NAKED FILTER HOLDERS

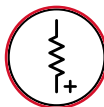

ENHANCED RESISTANCE

Napoli

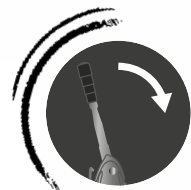

LEVER GROUP

High-performance lever group with Sanremo technology

TEMPERATURE SETTING DISPLAY

Allows the regulation of the water temperature



Characteristics



MANUAL BOILER LOAD
Allows to bypass the electronic-level control.



ELECTRONIC AUTO-LEVEL
Through an electronic level probe the boiler is automatically filled and maintained to the right filling level.

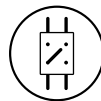

STATIC RELAY BOILER TEMPERATURE
Allows to regulate the temperature as accurately as possible.



GLASS LEVEL
Allows to monitor the water level in the boiler.

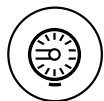

BOILER PRESSURE GAUGE
Allows to control the boiler pressure.



PUMP PRESSURE GAUGE
Allows to control the distribution pressure.



EASY SERVICE
Fast access to the internal parts for quick and easy technical service.



TEMPERATURE SETTING DISPLAY
Allows to regulate with precision the water temperature in the boiler for the production of coffee.

Other



EXTERNAL VOLUMETRIC PUMP



ENHANCED RESISTANCE



CUP WARMER
Dedicated resistor to keep all the cups at the optimal temperature.



Versions

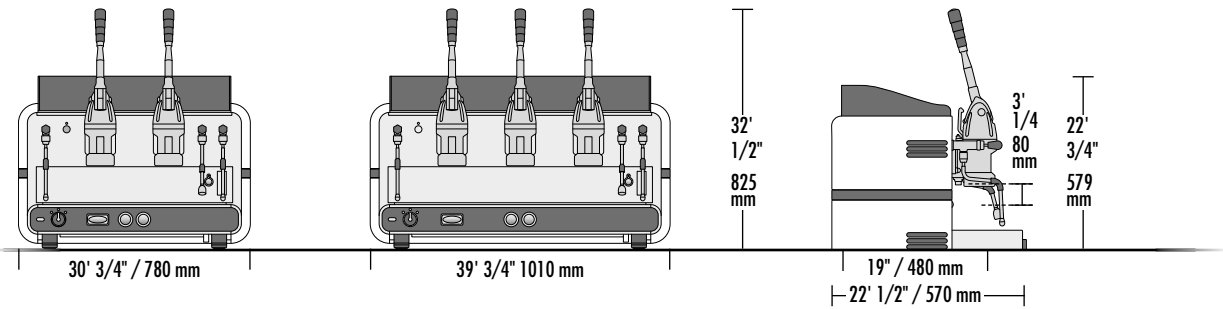

2 group
2 steam taps
1 water tap
1 one-cup filter holder
2 two-cup filter holders

3 group
2 steam taps
1 water tap
1 one-cup filter holder
3 two-cup filter holders



Colours

	Black	RAL 9005
	White	RAL 9003
	White/Matte black	RAL 9003/9005
	White/Red	RAL 9003/3002



Technical data

		2 group	3 group
voltage	V	220-240 1N / 380-415 3N	
max input boiler/steam boiler's resistor power	kW	4.85 / 4.5	5.65 / 5.5
steam boiler capacity	lt	12	19
pump power	kW	0.13	0.13
net weight	lb / kg	172 / 78	240 / 109
gross weight (with shipping crate)	lb / kg	194 / 88	254 / 115

*4 group machine available upon request



Napoli
Link to the website



Torino

LED LIGHTING OF THE WORKING AREA

Allows to effectively work in any light condition (optional)



SED VERSION

Guarantees an electronic dosing system through the button panel



SAP VERSION

Allows the semi-automatic programming of doses



GROUP SR 61

Optimized to maintain the ideal coffee extraction temperature



Versions

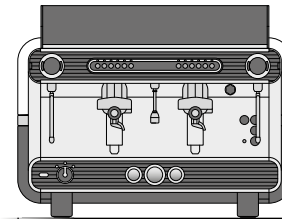

31" / 780 mm

2 group SED/SAP

2 steam taps
1 water tap
1 one-cup filter holder
2 two-cup filter holders

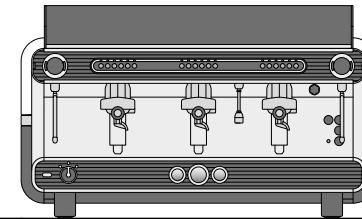

40" / 1010 mm

3 group SED/SAP

2 steam taps
1 water tap
1 one-cup filter holder
3 two-cup filter holders

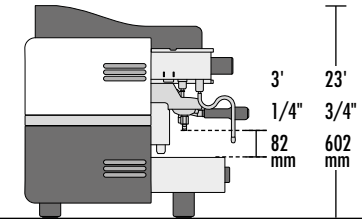

17' 1/3" / 440 mm
22' 1/2" / 570 mm

Colours

	Black	RAL 9005
	White	RAL 9003
	White Matte black	RAL 9003 9005
	White Red	RAL 9003 3002



Characteristics



Torino
Link to the website



ELECTRONIC AUTO-LEVEL
Through an electronic level probe the boiler is automatically filled and maintained to the right filling level.



PUMP PRESSURE GAUGE
Allows to control the distribution pressure.



EASY SERVICE
Fast access to the internal parts for quick and easy technical service.



ACTIVATED ELECTRONIC PRE-INFUSION
Management of the delayed activation of water solenoid in the first phase of brewing.



GROUP SR 61
Chromed brass grouphead with thermosiphonic circulation system optimized to maintain the ideal coffee extraction temperature.



AUTOMATIC CLEANING CYCLE
Process to clean the coffee groups.



BOILER PRESSURE GAUGE
Allows to control the boiler pressure.

Other



LED LIGHTING OF THE WORK AREA
Allows efficient working in any condition of environmental lighting.



EXTERNAL VOLUMETRIC PUMP



CUP WARMER
Dedicated resistor to keep all the cups at the optimal temperature.



NAKED FILTER HOLDERS



COMPETITION FILTERS
Exclusive Sanremo design, with shape and volume designed to capture the best coffee aromas and fragrances.



ENHANCED RESISTANCE



Technical data

		2 group	3 group
voltage	V	220-240 1N	380-415 3N
max input boiler/steam boiler's resistor power	kW	3.15 / 2.7	5.35 / 5.1
		5.1 / 4.5	
steam boiler capacity	lit	12.7	19
pump power	kW	0.15	0.15
net weight	lb / kg	139 / 63	196 / 89
gross weight (with shipping crate)	lb / kg	154 / 70	207 / 94

Zoe Competition



COLORED AND VERSATILE

Totally matching every type of decorative solution thanks to the possible customizations



SHOT TIMER

To accurately and reliably time coffee extraction



LED LIGHTING OF THE WORKING AREA

Allows to effectively work in any light condition



EASY SERVICE

Fast access to the internal parts for quick and easy technical service



LOW SERVICE COST

Designed to decrease the maintenance and inspection costs



Characteristics



ELECTRONIC AUTO-LEVEL
Through an electronic level probe the boiler is automatically filled and maintained to the right filling level.



ACTIVATED ELECTRONIC PRE-INFUSION
Management of the delayed activation of water solenoid in the first phase of brewing.



DOUBLE READING GAUGE
Allows to control at the same time the boiler pressure and the distribution pressure.



EASY SERVICE
Fast access to the internal parts for quick and easy technical service.



AUTOMATIC CLEANING CYCLE
Process for coffee groups cleaning.



LED LIGHTING OF THE WORK AREA
Allows efficient working in any condition of environmental lighting.



SHOT TIMER
To accurately and reliably time coffee extraction.

Other



AUTOSTEAMER
Steam wand characterized by an electronic system that allows to mount and/or heat milk at the set temperature.



CUP WARMER
Dedicated resistor to keep all the cups at the optimal temperature.



EXTERNAL VOLUMETRIC PUMP



NAKED FILTER HODERS



ENHANCED RESISTANCE

Versions

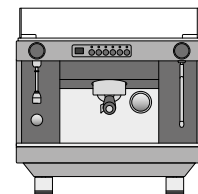

21" / 530 mm

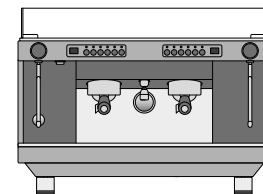

28" 2/4" / 720 mm

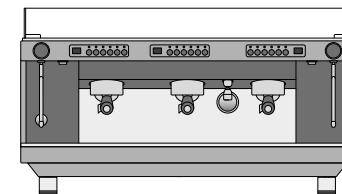

37" 2/4" / 950 mm

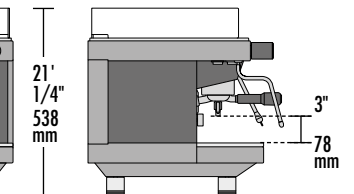

14" 1/2" / 368 mm
19" 2/3" / 500 mm

1 group

- 1 steam tap
- 1 water tap
- 1 one-cup filter holder
- 1 two-cup filter holder

2 group

- 2 steam taps
- 1 water tap
- 1 one-cup filter holder
- 2 two-cup filter holders

3 group

- 2 steam taps
- 1 water tap
- 1 one-cup filter holder
- 3 two-cup filter holders

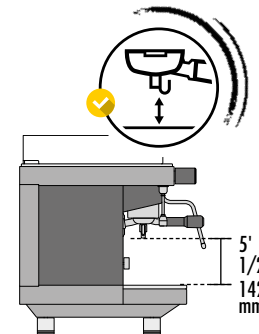

24" 602 mm
5" 1/2" 142 mm

TALL VERSION

2-3 group



Technical data

		1 group	2 group	3 group
voltage	V	220-240 1N / 380-415 3N		
max input boiler/steam boiler's resistor power	kW	2.35 / 1.95	3.15 / 2.7	5.8 / 5.1
			4.3 / 4.0	
			4.8 / 4.5	
steam boiler capacity	lt	5	9	12.5
pump power	kW	0.15	0.15	0.15
net weight	lb / kg	93 / 42	121 / 55	152 / 69
gross weight (with shipping crate)	lb / kg	104 / 47	130 / 59	161 / 73

Colours

	Black	RAL 9005
	White Black	RAL 9003 9005
	White Matte black	RAL 9003 9005
	White Red	RAL 9003 3002

PERSONALISED GRAPHICS

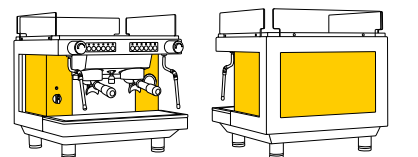

Zoe Competition
Link to the website

Customization of internal panels with graphics and colors (on request).

Zoe

COLORED AND VERSATILE

Totally matching every type of decorative solution thanks to the possible customizations



SED VERSION

Guarantees an electronic dosing system through the button panel



SAP VERSION

Allows the semi-automatic programming of doses



COMPLETE RANGE

Available versions: SED and SAP, 1-2-3 group, Tall and Compact

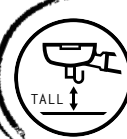
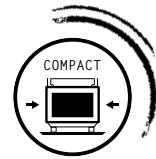

EASY SERVICE

Fast access to the internal parts for quick and easy technical service

LOW SERVICE COST

Designed to decrease the maintenance and inspection costs



Characteristics



ELECTRONIC AUTO-LEVEL

Through an electronic level probe the boiler is automatically filled and maintained to the right filling level.



ACTIVATED ELECTRONIC PRE-INFUSION

Management of the delayed activation of water solenoid in the first phase of brewing.



DOUBLE READING GAUGE

Allows to control at the same time the boiler pressure and the distribution pressure.



EASY SERVICE

Fast access to the internal parts for quick and easy technical service.



AUTOMATIC CLEANING CYCLE

Process for coffee groups cleaning.

Other



AUTOSTEAMER

Steam wand characterized by an electronic system that allows to mount and/or heat milk at the set temperature.



CUP WARMER

Dedicated resistor to keep all the cups at the optimal temperature.



EXTERNAL VOLUMETRIC PUMP



NAKED FILTER HOLDERS



ENHANCED RESISTANCE



Versions

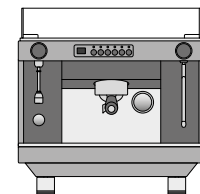

21" / 530 mm

1 group SED/SAP

- 1 steam tap
- 1 water tap
- 1 one-cup filter holder
- 1 two-cup filter holder

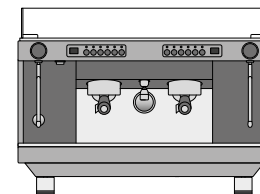

28" 2/4" / 720 mm

2 group SED/SAP

- 2 steam taps
- 1 water tap
- 1 one-cup filter holder
- 2 two-cup filter holders

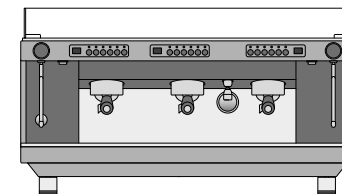

37" 2/4" / 950 mm

3 group SED/SAP

- 2 steam taps
- 1 water tap
- 1 one-cup filter holder
- 3 two-cup filter holders

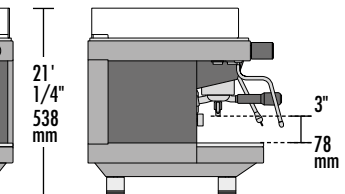

14" 1/2" / 368 mm

19" 2/3" / 500 mm

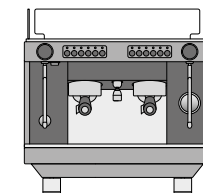

20" 3/4" / 530 mm

COMPACT VERSION

2 group

- 2 steam taps
- 1 water tap
- 1 one-cup filter holder
- 2 two-cup filter holders

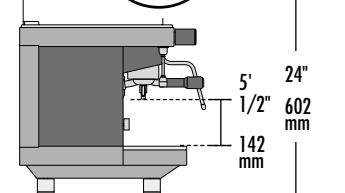

24" 602 mm

TALL VERSION

2-3 group

- SED
- SAP

Technical data

		1 group	2 group	3 group	Kompact
voltage	V	220-240 1N / 380-415 3N			220-240 1N
max input boiler/steam boiler's resistor power	kW	2.35 / 1.95	3.15 / 2.7	5.8 / 5.1	2.7 / 2.5
			4.3 / 4.0		
			4.8 / 4.5		
steam boiler capacity	lt	5	9	12.5	7
pump power	kW	0.15	0.15	0.15	0.15
net weight	lb / kg	93 / 42	121 / 55	152 / 69	99 / 45
gross weight (with shipping crate)	lb / kg	104 / 47	130 / 59	161 / 73	113 / 51

Colours

	Black	RAL 9005
	White/Black	RAL 9003/9005
	White/Matte black	RAL 9003/9005
	White/Red	RAL 9003/3002

PERSONALISED GRAPHICS

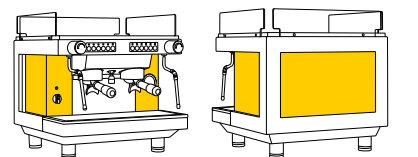

Zoe
Link to the website

Customization of internal panels with graphics and colors (on request).

Cube

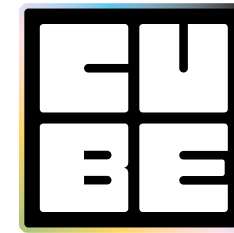

MAIN DISPLAY USER

- Views:
- Boiler temperature (range 239/ 258,8°F)
 - Extraction time
 - Water level
 - Malfunction

Settings:
Water filter expiration date (1-12 mths)

APP CONNECTION



LED INDICATORS

- On/Off
- At temperature
- Water level alarm

ENERGY SAVING SYSTEM

Component insulation and smart electronics for maximum energy efficiency



PRESSURE GAUGE BOILER PRESSURE

Range 0-36 psi



PRESSURE GAUGE PUMP PRESSURE

Range 0-232 psi

Characteristics

- + 1.9L boiler in AISI 316 stainless steel
- + 1.8L internal water tank
- + Thermosyphon unit with mechanical pre-infusion
- + Boiler power 1500W/230Vac - 1300W/120Vac
- + 54 L/h high performance volumetric pump
- + Energy Saving System
- + WiFi connection with Web App
- + Water supply that can be selected from internal tank or mains
- + Digital display
- + Complete kit of useful accessories



Versions

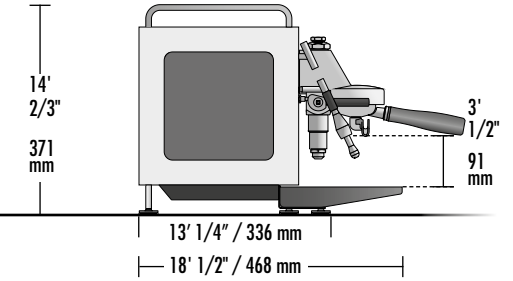
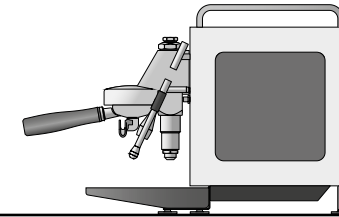
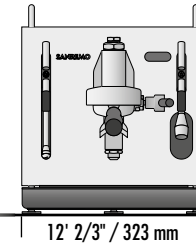

WeightKg 27,7 | 61 lbs



Cube
Link to the website

WiFi connection with Web App



It is possible to manage multiple machines - located in different places - using the same App.

- + Remote machine on/off
- + Set-up boiler temperature
- + Manage water tank level
- + Enable and manage water filter signaling
- + Show shot time in real time
- + Statistics: daily, weekly and monthly counters for coffee and water consumption
- + Weekly scheduler to program up to three different "time slot" per day

APP & WIFI TECHNOLOGY



CUBE



2 different body styles: A and B.

Cube A

In style A, the machine coating panels come in single colour.



Standard colours



Special colours



Cube B

In style B, the side panels feature two parts characterised by a two-colour finish.







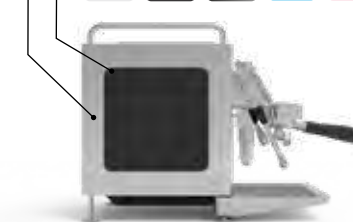

Available finishes of the body



Available finishes for the central box



-  Snow White
-  Onyx Black
-  Stainless Steel
-  Azure Lake
-  Candy Pink
-  Matcha Green
-  Yolk Yellow
-  Racing Red



You



CUSTOMIZABLE PRESETS

USER-FRIENDLY

Intuitive touch screen display



FRONT LEVER (PADDLE)

Electronically managed to create and modify profiles



ENERGY SAVING SYSTEM

Component insulation and smart electronics for maximum energy efficiency

MULTI-BOILER

The boilers for both the coffee and the auxiliary services are made from AISI 316 stainless steel, and are fully insulated

FULL CONFIGURATION

Equipped with tank (2,5l) and water mains connection



CONNECTIVITY

USB and Wifi



VOLUMETRIC PUMP

*70 litre 24V
Excellent stability during pressure/flow profiling*

(*) Flow made and WiFi module during the year 2023

Caratteristiche



MIXED INFUSION HOT WATER FOR TEA AND HERBAL TEAS
Immediate mixing of cold / hot water for a better chemical and organoleptic quality.



AUTO-ON, AUTO-OFF AND DAY-OFF FUNCTION
Programmable ON-OFF/ON-ECO timer for each day and/or daily timetables.



TEMPCONTROL
For a very-high thermal stability (± 0.2 °C).

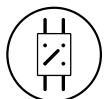

STATIC RELAY BOILER TEMPERATURE
Allows to regulate the temperature as accurately as possible.



EASY SERVICE
Fast access to the internal parts for quick and easy technical service.



GROUP FLUSHING
With a simple pressure of the button a small quantity of water is dispensed to allow the group to be always clean.



STAINLESS STEEL COFFEE BOILER
Guarantees excellent stability and thermal precision, associated with resistance to oxidation and limestone.



AUTOMATIC CLEANING CYCLE
Process for coffee group cleaning.



VOLUMETRIC PUMP
A new generation rated 70 L/h for pressure and flow profiling



LED LIGHTING OF THE WORK AREA
Allows efficient working in any condition of environmental lighting.



ENERGY SAVING SYSTEM
Component insulation and smart electronics for maximum energy efficiency.



Versions

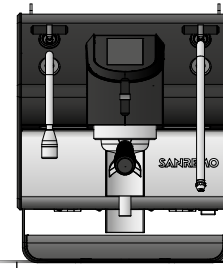

13" / 328 mm

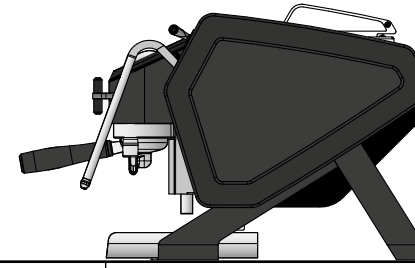

21' 2/3" / 542 mm

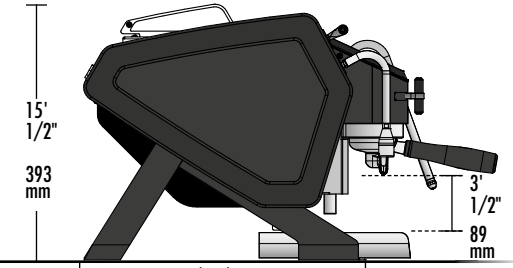

16' 2/3" / 422 mm

15' 1/2"
393 mm

3' 1/2"
89 mm

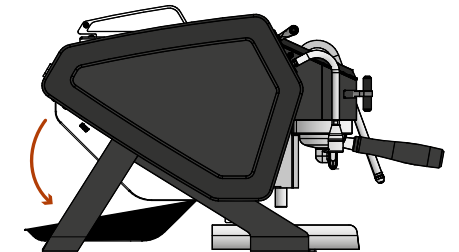

Technical data

voltage/max input boiler	V	220-240V / 50-60HZ / 2.20 kW
		110-120V / 50-60HZ / 1.65 kW
		100V / 50-60HZ / 1.45 kW
coffee boiler's resistor power	W	500
steam boiler capacity	lt	1
coffee boiler capacity	l	0.5
net weight	lb / kg	70.5 / 32
gross weight	lb / kg	79 / 36

Colors

	Black: matt glossy (frames)	RAL 9005
	White: matt glossy (frames) legs and side	RAL 9003 RAL 8019
	Custom: Side panels in leather or wood Knob lever and wooden paddle lever	

Custom kits in leather and wood available soon, check on our website.



You
Watch the video

Customizable Presets

Extraction profiles customizable and savable:

- 6 standard profiles with optimal parameters presets
- 12 completely customizable profiles in all 3 extraction phases, with a capacity to disable pre-infusion and post-infusion the Paddle
- Set your manual profiles from the Paddle



Electronic Paddle

Manually create your profiles in both extraction modes.

Configure the Paddle (right/left) based on your gestures.

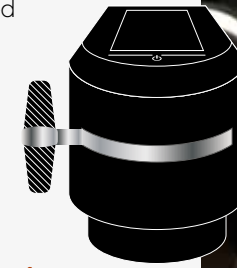

54

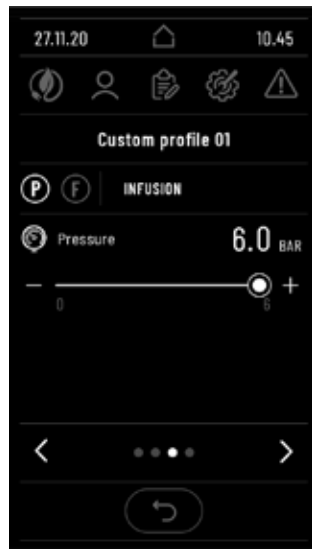

YOU

MADE FOR YOU BY **SANREMO**



"ON THE FLY" function to correct the flow/pressure parameters in real time during your extraction process.

Extraction mode

Set your extraction profiles in **Pressure** or **Flow** mode.(*)

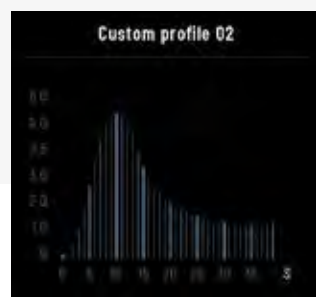
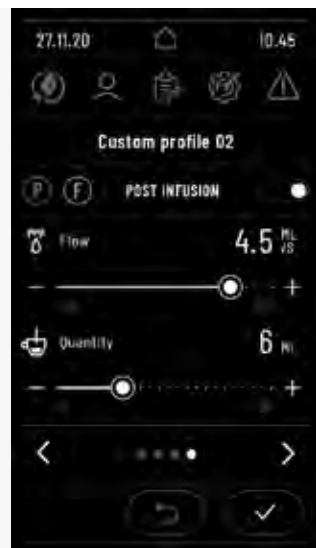
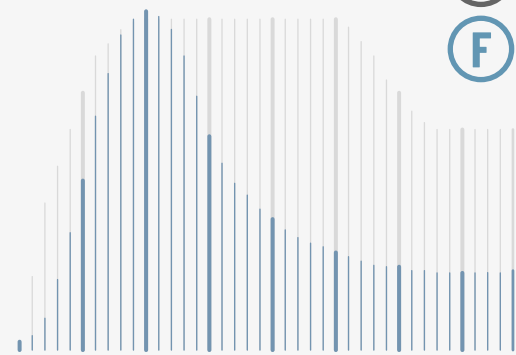

Energy efficiency



Setting:

- **Automatic:** allows the user to associate up to 6 daily time frames.
- **Manual:** allows the user to turn the machine or the individual boilers on and off manually.

Two programmable modes:

- **Stand-by:** low power consumption condition, compliant with the ErP Directive (2009/125/EC).
- **Eco:** keeps the machine on, but at a reduced temperature for quick start-up.

For both, the user can enable the Energy Saving function, which automatically turns the machine off after the set time.

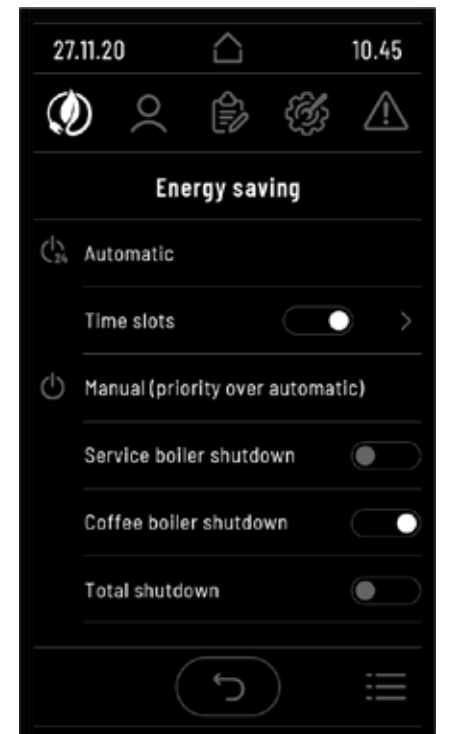

(*) Flow mode and WiFi module during the year 2023

Grinders



GRINDERS
SANREMO

On demand / Grinder doser

SR 83 OD



HIGHT PERFORMANCE

Flat burrs (ø 83 mm)
"Red speed" burrs (optional)



PRECISE GRINDING ADJUSTMENT

Mechanical micrometric with ring nut

EVERYTHING UNDER CONTROL

Display full touch screen

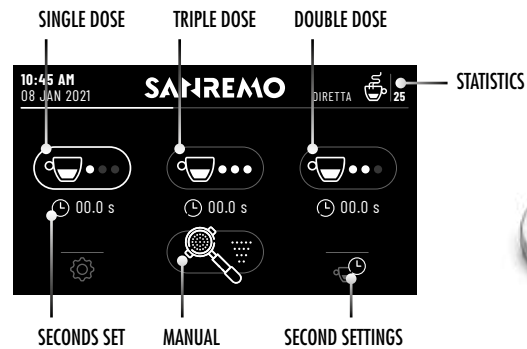

Optional

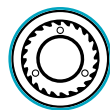

"RED SPEED" BURRS
Improves the quality of grinding and offers a much longer life span. (PVD-coated)



INVERTER TECHNOLOGY

The system ensures absolute precision and consistency for grinding, reducing motor consumption, operating noiselessly and showing exceptional reliability even during long time operations.

Technical data		SR 83 OD
power	W	650
burrs	-	flat
disks diameter	inch / mm	3' 1/4" / 83
motor speed 50 Hz	rmp	1350
motor speed 60 Hz	rmp	1550
coffee beans hopper capacity	lb / kg	3.3 / 1.5
net weight	lb / kg	33 / 15
width	inch / mm	9" / 230
height	inch / mm	26' 2/4" / 670
dept	inch / mm	10' 3/4" / 270

On demand / Conical grinder doser

SR 64 OD



HIGHT PERFORMANCE

Flat burrs (ø 83 mm)
"Red speed" burrs (optional)



PRECISE GRINDING ADJUSTMENT

Mechanical micrometric with ring nut

EVERYTHING UNDER CONTROL

Display full touch screen

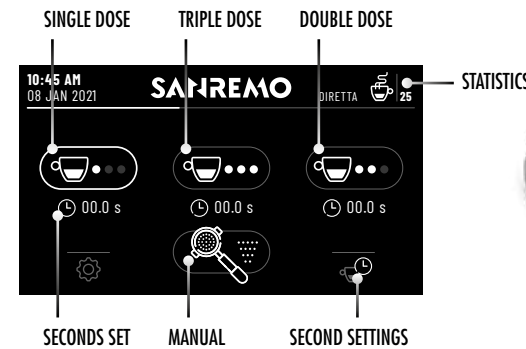

Grinders
Link to the website

Colours

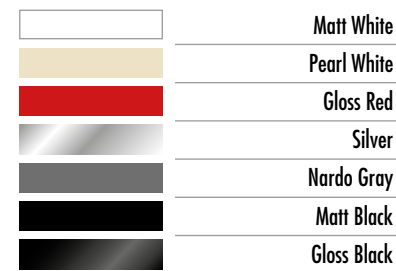

• Shiny aluminium version available on request, with a price increase

Technical data		SR 64 OD
power	W	350
burrs	-	flat
disks diameter	inch / mm	2' 2/4" / 64
motor speed 50 Hz	rmp	1350
motor speed 60 Hz	rmp	1550
coffee beans hopper capacity	lb / kg	3.3 / 1.5
net weight	lb / kg	28.6 / 13
width	inch / mm	9" / 230
height	inch / mm	24' 1/4" / 615
dept	inch / mm	10' 3/4" / 270

On demand / Grinder doser

ON DEMAND



SR 83 OD PRO

60



HIGHT PERFORMANCE
Flat burrs (ø 83 mm)
"Red speed" burrs (optional)

EVERYTHING UNDER CONTROL
Display full touch screen

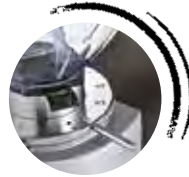

PRECISE GRINDING ADJUSTMENT
Mechanical micrometric with ring nut



DETACHABLE GRINDING CHAMBER
Easy to release
Available for SR 83 OD PRO and SR 64 OD EVO PRO

On demand / Grinder doser

ON DEMAND



SR 64 OD EVO PRO

61



HIGHT PERFORMANCE
Flat burrs (ø 83 mm)
"Red speed" burrs (optional)

EVERYTHING UNDER CONTROL
Display full touch screen



PRECISE GRINDING ADJUSTMENT
Mechanical micrometric with ring nut



DETACHABLE GRINDING CHAMBER
Easy to release
Available for SR 83 OD PRO and SR 64 OD EVO PRO

Optional



"RED SPEED" BURRS
Improves the quality of grinding and offers a much longer life span. (PVD-coated)

Available for SR 83 OD, SR 64 OD EVO and SR 64 OD EVO PRO models.

Technical data

		SR 83 OD PRO
power	W	650
burrs	-	flat
disks diameter	inch / mm	3' 1/4" / 83
motor speed 50 Hz	rmp	1350
motor speed 60 Hz	rmp	1550
coffee beans hopper capacity	lb / kg	3.3 / 1.5
net weight	lb / kg	33 / 15
width	inch / mm	9" / 230
height	inch / mm	26' 2/4" / 670
dept	inch / mm	10' 3/4" / 270



Colours

	Matt White
	Pearl White
	Gloss Red
	Silver
	Nardo Gray
	Matt Black
	Gloss Black

• Shiny aluminium version available on request, with a price increase

Technical data

		SR 64 OD EVO PRO	SR 64 OD EVO
power	W	350	350
burrs	-	flat	flat
burrs diameter	inch / mm	2' 2/4" / 64	2' 2/4" / 64
motor speed 50 Hz	rmp	1350	1350
motor speed 60 Hz	rmp	1550	1550
coffee beans hopper capacity	lb / kg	3.3 / 1.5	3.3 / 1.5
net weight	lb / kg	28.6 / 13	28.6 / 13
width	inch / mm	9" / 230	9" / 230
height	inch / mm	24' 1/4" / 615	24' 1/4" / 615
dept	inch / mm	10' 3/4" / 270	10' 3/4" / 270



AllGround

**C
U
B
E**

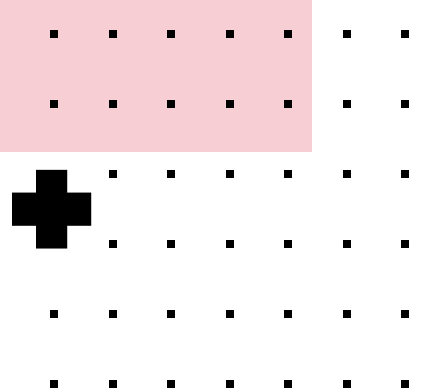

CUBE Grinders AllGround



Snow White



Onyx Black



Stainless Steel



Azure Lake



Candy Pink



Matcha Green



Yolk Yellow



Racing Red



CE

Technical data

power	W	250
burrs	-	flat with titanium coating
burrs diameter	inch / mm	2' 2/4" / 64
motor speed 50 Hz	rmp	1400
motor speed 60 Hz	rmp	1600
coffee beans hopper capacity	lb / kg	0.55 / 0.25
net weight	lb / kg	19.8 / 9
width	inch / mm	6' 3/4" / 169
height	inch / mm	17' 1/4" / 440
dept	inch / mm	9' 2/4" / 240

made for
each other



