















CONTENTS

1. INTRODUCTION	7
1.1 Letters in brackets	7
1.2 Troubleshooting and repairs.....	7
1.3 Download the App!	7
2. DESCRIPTION	7
2.1 Description of the appliance (page 3 - A)	7
2.2 Description of the homepage (main screen) (page 2 - B)	7
2.3 Description of the accessories (page 2 - C)....	8
2.4 "Cleaning the milk container" (page 2 - D)....	8
3.  SETTING UP THE APPLIANCE	8
4.  TURNING THE APPLIANCE ON	8
5. TURNING THE APPLIANCE OFF	8
6.  MENU SETTINGS	9
6.1 Rinsing	9
6.2 Descaling	9
6.3 Water filter	9
6.4 Beverages settings	9
6.5 Auto-off (standby)	9
6.6 Energy saving	9
6.7 Coffee temperature	10
6.8 Water hardness	10
6.9 Selecting the language	10
6.10 Beep	10
6.11 Cup light	10
6.12 Bluetooth	10
6.13 Default values	10
6.14 Statistics	11
6.15 Customise profile	11
7.  MAKING COFFEE	11
7.1 Selecting the coffee aroma.....	11
7.2 Selecting the coffee quantity	11
7.3 Making coffee using coffee beans	11
7.4 Making coffee using pre-ground coffee.....	12
7.5 Adjusting the coffee mill	12
7.6 Tips for a hotter coffee.....	12
8.  MAKING CAPPUCCINOS AND MILK- BASED COFFEES	13
8.1 Filling and attaching the milk container.....	13
8.2 Adjusting the amount of froth.....	13
8.3 Making cappuccinos and milk-based coffees automatically	13
8.4 Cleaning the milk container after use	13
9.  DELIVERING HOT WATER	14
10.  STEAM DELIVERY	14
10.1 Tips for using steam to froth milk.....	14
10.2 Cleaning the hot water/steam spout after use	14
12.  CUSTOMISING THE BEVERAGES	15
13.  MEMORISING YOUR PERSONAL PROFILE	15
14.  CLEANING	16
14.1 Cleaning the machine	16
14.2 Cleaning the machine's internal circuit	16
14.3 Cleaning the coffee grounds container	16
14.4 Cleaning the drip tray and condensate tray	16
14.5 Cleaning the inside of the coffee machine	16
14.6 Cleaning the water tank.....	17
14.7 Cleaning the coffee spouts	17
14.8 Cleaning the pre-ground coffee funnel	17
14.9 Cleaning the infuser	17
14.10 Cleaning the milk container	17
14.11 Cleaning the hot water/steam connection nozzle.....	18
15.  DESCALING	18
16.  SETTING WATER HARDNESS	19
16.1 Measuring water hardness	19
16.2 Setting water hardness	19
17.  WATER SOFTENER FILTER	19
17.1 Installing the filter	20
17.2 Replacing the filter.....	20
17.3 Removing the filter	20
18. TECHNICAL DATA	21
19.  DISPLAYED MESSAGES	21
20.  TROUBLESHOOTING	26

2.3 Description of the accessories (page 2 - C)

- C1. "Total Hardness Test" indicator paper (attached to page 2 of the English instructions)
- C2. Pre-ground coffee measure
- C3. Descaler
- C4. Water softener filter (*certain models only)
- C5. Cleaning brush
- C6. Hot water/steam spout
- C7. Spout release button

2.4 "Cleaning the milk container" (page 2 - D)

- D1. Froth adjustment and CLEAN dial
- D2. Milk container lid
- D3. Milk container
- D4. Milk intake tube
- D5. Frothed milk spout (adjustable)

3. SETTING UP THE APPLIANCE

Please note!

- The first time you use the appliance, rinse with hot water all removable accessories which may come into contact with water or milk.
- Possible traces of coffee in the mill are the result of operating tests performed on the appliance before sale, proof of the meticulous care and attention we invest in our products.
- You should customise water hardness as soon as possible following the instructions in section "16. Setting water hardness".

1. Connect the appliance to the mains supply (fig. 1).
2. "SELECT LANGUAGE": Press the selector (B2) corresponding to "NEXT>" until the required language appears on the display (B1), then press the selector corresponding to the language.

Follow the instructions indicated on the appliance display:

3. "FILL TANK WITH FRESH WATER": remove the water tank (A16) (fig. 2), open the lid (A15) (fig. 3), fill to the MAX line (marked on the inside of the tank) with fresh water (fig. 4), close the lid and put the tank back in the appliance (fig. 5);
4. "INSERT WATER SPOUT": Check that the hot water/steam spout (C6) is inserted on the connection nozzle (A9) (fig. 6) and place a container holding a minimum of 100 ml underneath (fig. 7);
5. WATER CIRCUIT EMPTY PRESS OK TO START: press the selector corresponding to "✓ OK" to confirm. The appliance delivers hot water from the spout (fig. 7) then goes off automatically.

The coffee machine is now ready for normal use.

Please note!

- The first time you use the appliance, you need to make 4-5 cappuccinos before it starts to give satisfactory results.
- The first time you use the machine, the water circuit is empty and the appliance could be very noisy. The noise becomes less as the circuit fills.
- When making the first 5-6 cappuccinos, it is normal to hear the noise of boiling water. After this, the noise becomes less.
- To improve the performance of your appliance, we recommend installing a water softener filter (C4) as described in section "17. Water softener filter". If your model is not provided with a filter, you can request one from De'Longhi Customer Services.

4. TURNING THE APPLIANCE ON

Please note!

Each time the appliance is turned on, it performs an automatic preheat and rinse cycle which cannot be interrupted. The appliance is ready for use only after completion of this cycle.

- To turn the appliance on, press the  button (A7-fig. 8). The message "HEATING UP UNDERWAY PLEASE WAIT" appears on the display.
- When heating is complete, the message changes to: "RINSING UNDERWAY, PLEASE WAIT"; as well as heating the boiler, this also heats the internal circuits by circulating hot water.

The appliance is at temperature when the main screen (home-page) appears.

5. TURNING THE APPLIANCE OFF

Whenever the coffee machine is turned off after being used to make coffee, it performs an automatic rinse cycle.

- To turn the appliance off, press the  button (A7) (fig. 9).
- The message "TURNING OFF UNDERWAY, PLEASE WAIT" is displayed, then the appliance performs a rinse cycle and goes off (standby).

Please note!

If you will not be using the appliance for some time, unplug from the mains socket:

Important!

Always turn the appliance off with the  button (standby) before unplugging it from the mains supply.



6. MENU SETTINGS

6.1 Rinsing

Use this function to deliver hot water from the coffee spouts (A8) and hot water/steam spout (C6), if inserted, to clean and heat the appliance's internal circuit.

Place a container with a minimum capacity of 100ml under the coffee and hot water spouts (fig. 7).

To enable the function, proceed as follows:

1. Press the selector (B2) corresponding to the  symbol (B5) to enter the menu;
2. Press the selector corresponding to " RINSING";
3. After a few seconds, hot water is delivered first from the coffee spouts, then from the hot water/steam spout (if inserted) to clean and heat the appliance's internal circuit. "RINSING UNDERWAYPLEASE WAIT" appears on the display, together with a progress bar which fills gradually as preparation proceeds;
4. To interrupt rinsing, press the selector corresponding to " STOP" or wait for rinsing to stop automatically.

Please note!

- If the appliance is not used for more than 3-4 days, when switched on again, we strongly recommend performing 2/3 rinses before use;
- After cleaning, it is normal for the coffee grounds container (A10) to contain water.

6.2 Descaling





For instructions on descaling, see section "15. Descaling".





6.3 Water filter

For instructions on how to install the filter (C4), see section "17. Water softener filter".

6.4 Beverages settings

In this section, you can consult your customised settings and, if you wish, reset the default values for each beverage.

1. Press the selector (B2) corresponding to the  symbol (B5) to enter the menu;
2. Scroll through the menu items by pressing the selector corresponding to "NEXT>" until " BEVERAGES SETTINGS" appears on the display;
3. Press the selector corresponding to " BEVERAGES SETTINGS". The values for the first beverage appear on the display;
4. The reference user profile is highlighted on the display. The values are displayed on vertical bars. The default value is indicated by the  symbol, while the current value is highlighted by the solid part of the vertical bar;
5. To go back to the settings menu, press the selector corresponding to " ESC". To scroll through and display the beverages, press the selector corresponding to "NEXT>";

6. To reset the default values for the beverage displayed, press the selector corresponding to " RESET";
7. "CONFIRM RESET?": to confirm press the selector corresponding to " OK" (to cancel, press the selector corresponding to " ESC");
8. "DEFAULT VALUES SET": press " OK".

The beverage has been reset to the default values. Proceed with the other beverages or go back to the homepage by pressing the arrow corresponding to " ESC" twice.







Please note!

- To change the beverages in another profile, go back to the homepage, select the required profile (B11) and repeat the procedure.
- To reset all the beverages in the profile to the default values, see section "7. Making coffee".

6.5 Auto-off (standby)

Auto-off can be set so that the appliance goes off after 15 or 30 minutes, or 1, 2 or 3 hours.

To programme Auto-off, proceed as follows:





1. Press the selector (B2) corresponding to the  symbol (B5) to enter the menu;
2. Scroll through the menu items by pressing the selector corresponding to "NEXT>" until " AUTO-OFF" appears on the display;
3. Press the selector corresponding to " AUTO-OFF";
4. Select the required time interval by pressing the selection arrows corresponding to  (increase) or  (decrease);
5. To confirm, press the selector corresponding to " OK";
6. Press the selector corresponding to " ESC" to go back to the homepage.

Auto-off is now programmed.

6.6 Energy saving

Use this function to enable or disable energy saving. When enabled, the function reduces energy consumption in compliance with European regulations.

To disable or enable "Energy Saving", proceed as follows:

1. Press the selector (B2) corresponding to the  symbol (B5) to enter the menu;
2. Scroll through the menu items by pressing the selector corresponding to "NEXT>" until "ENERGY SAVING" appears on the display;
3. Press the selector corresponding to "ENERGY SAVING" to disable () or enable () the function.
4. Press the selector corresponding to " ESC" to go back to the homepage.

The corresponding symbol appears on the display to indicate that the function has been enabled.

6.7 Coffee temperature

To modify the temperature of the water used to make the coffee, proceed as follows:



1. Press the selector (B2) corresponding to the  symbol (B5) to enter the menu;
2. Scroll through the menu items by pressing the selector corresponding to "NEXT>" until "☕ COFFEE TEMPERATURE" appears on the display;
3. Press the selector corresponding to "☕ COFFEE TEMPERATURE". The selectable values appear on the display (B1) (the current value is underlined);
4. Press the selector corresponding to the value you want to set (LOW, MEDIUM, HIGH, MAXIMUM);
5. Press the selector corresponding to "↩ ESC" twice to go back to the homepage.

6.8 Water hardness

For instructions on setting water hardness, see section "16. setting water hardness".



6.9 Selecting the language

To modify the language of the display (B1), proceed as follows:

1. Press the selector (B2) corresponding to the  symbol (B5) to enter the menu;
2. Scroll through the menu items by pressing the selector corresponding to "NEXT>" until "SET LANGUAGE " appears on the display;
3. Press the selector corresponding to "IMPOSTA ";
4. Press the selector corresponding to the language required (press the selector corresponding to "NEXT>" to display all the languages available);
5. Press the selector corresponding to "↩ ESC" twice to go back to the homepage.

6.10 Beep



This enables or disables the beep emitted by the machine each time an icon is pressed or an accessory is inserted/removed. To disable or enable the beep, proceed as follows:

1. Press the selector (B2) corresponding to the  symbol (B5) to enter the menu;
2. Scroll through the menu items by pressing the selector corresponding to "NEXT>" until "BEEP" appears on the display;
3. Press the selector corresponding to "BEEP" to disable  or enable  the function;
4. Press the selector corresponding to "↩ ESC" to go back to the homepage.

6.11 Cup light



This function enables or disables the cup lighting. The lights come on each time a coffee or milk-based beverage is made and during each rinsing cycle.

To disable or enable this function, proceed as follows:

1. Press the selector (B2) corresponding to the  symbol (B5) to enter the menu;
2. Scroll through the menu items by pressing the selector corresponding to "NEXT>" until "CUP LIGHTING" appears on the display;
3. Press the selector corresponding to "CUP LIGHTING" to disable  or enable  the function;
4. Press the selector corresponding to "↩ ESC" to go back to the homepage.

6.12 Bluetooth

This function enables or disables the protection PIN to connect to the appliance from a device.

1. Press the selector (B2) corresponding to the  symbol (B5) to enter the menu;
2. Scroll through the menu items by pressing the selector corresponding to "NEXT>" until "📶 BLUETOOTH" appears on the display;
3. Press the selector corresponding to "📶 BLUETOOTH". The serial number of the machine (19 digits) and a 4 digit number (PIN) appear on the display (B1);
4. Press the selector to disable  or enable  the request for the PIN when you connect via the App;
5. Press the selector corresponding to "↩ ESC" twice to go back to the homepage.

The preset PIN is "0000". You are recommended to customise the PIN directly from the APP.

Please note!

The serial number of the appliance, visible in the "Bluetooth" function, enables it to be identified unambiguously when an association is created with the APP.

6.13 Default values

This resets all menu settings and programmed quantities back to the default values (with the exception of the language which remains as set).

To reset the default values, proceed as follows:

1. Press the selector (B2) corresponding to the  symbol (B5) to enter the menu;
2. Scroll through the menu items by pressing the selector corresponding to "NEXT>" until "🏭 DEFAULT VALUES" appears on the display;
3. Press the selector corresponding to "🏭 DEFAULT VALUES". "RESET DEFAULT VALUES?" appears on the display (B1), to confirm press the selector corresponding to "✓ OK" (to cancel, press the selector corresponding to "↩ ESC");
4. "DEFAULT VALUES SET": to confirm, press the selector corresponding to "✓ OK";

- Press the selector corresponding to " ESC" to go back to the homepage.

6.14 Statistics

This displays statistics relating to the machine. To display the statistics, proceed as follows:

- Press the selector (B2) corresponding to the " symbol (B5) to enter the menu;
- Scroll through the menu items by pressing the selector corresponding to "NEXT>" until " STATISTICS" appears on the display;
- Press the selector corresponding to " STATISTICS" and check all the statistics by scrolling through the items using the selector corresponding to "NEXT>";
- Press " ESC" twice to go back to the homepage.

6.15 Customise profile

To customise the profile icon, proceed as follows:

- Press the selector (B2) corresponding to the " symbol (B5) to enter the menu;
- Scroll through the menu items by pressing the selector corresponding to "NEXT>" until " CUSTOMISE PROFILE" appears on the display;
- Press the selector corresponding to " CUSTOMISE PROFILE";
- Press the selector corresponding to the icon you want to select (press the selector corresponding to "NEXT>" to display all the icons available);
- Press the selector corresponding to " ESC" twice to go back to the homepage.

7. MAKING COFFEE

7.1 Selecting the coffee aroma

From the homepage, select the required coffee aroma by pressing the selector (B2) corresponding to "AROMA" (B10):

	(see "7.4 Making coffee using pre-ground coffee")
	EXTRA LIGHT
	LIGHT
	MEDIUM
	STRONG
	X-STRONG
	Custom (if programmed) / Standard

After delivering the beverage, the aroma setting is reset to the value.

7.2 Selecting the coffee quantity

From the homepage, select the required quantity of coffee in the cup by pressing the selector (B2) corresponding to "QUANTITY" (B11):

	SMALL SIZE
	MEDIUM SIZE
	LARGE SIZE
	EXTRA-LARGE SIZE
	Custom (if programmed) / Standard

After delivering the beverage, the quantity setting is reset to the value.

7.3 Making coffee using coffee beans

Important!

Do not use green, caramelised or candied coffee beans as they could stick to the coffee mill and make it unusable.

- Fill the container (A3) (fig. 10) with coffee beans;
- Place a cup under the coffee spouts (A8);
- Lower the spouts as near as possible to the cup (fig. 11). This makes a creamier coffee;
- Then select your required coffee:

Directly selected beverages:

- Espresso (B7)
- Coffee (B8)
- Long (B9)

Selectable from the beverage selection menu (B3):

- DOPPIO+
- AMERICANO
- 2X ESPRESSO

- Preparation begins. An image of the selected beverage appears on the display (B1) together with a progress bar which gradually fills as preparation progresses.

Please note:

- You can prepare 2 cups of ESPRESSO coffee at the same time by also pressing the selector corresponding to "2X



" during preparation of 1 ESPRESSO (the image is displayed for a few seconds at the start of preparation).

- While the machine is making coffee, delivery can be interrupted at any moment by pressing the selector (B2) corresponding to " STOP".

- As soon as delivery has ended, to increase the quantity of coffee in the cup, just press the selector (B2) corresponding to "⊕EXTRA". When the required quantity is reached, press the selector corresponding to "✕STOP".

Once the coffee has been made, the appliance is ready to make the next beverage.

Please note!

- Various alarm messages could be displayed while using the appliance (FILL TANK, EMPTY GROUNDS CONTAINER, ETC.). Their meaning is explained in section "20. Displayed messages".
- For hotter coffee, see section "7.6 Tips for a hotter coffee".
- If the coffee is delivered a drop at a time, too weak and not creamy enough or too cold, read the tips in section "7.5 Adjusting the coffee mill" and section "21. Troubleshooting".
- Preparation of each coffee can be customised (see sections "12. Customising the beverages" and "13. Memorising your personal profile").
- If "Energy Saving" mode is active, you may have to wait a few seconds before the first coffee is delivered

7.4 Making coffee using pre-ground coffee

Important!

- Never add pre-ground coffee when the machine is off or it could spread through the inside of the machine and dirty it. This could damage the appliance.
- Never use more than 1 level measure (C2) or it could dirty the inside of the coffee machine or block the funnel (A4).
- If you use pre-ground coffee, you can only make one cup of coffee at a time.

- Press the selector (B2) corresponding to "AROMA" (B10) until "☕" (ground) appears on the display (B1).
- Open the pre-ground coffee funnel lid (A2).
- Make sure the funnel (A4) is not blocked, then add one level measure of pre-ground coffee (fig. 12).
- Place a cup under the coffee spouts (A8) (fig. 11).
- Then select your required coffee:

Directly selected beverages:

- Espresso (B7)
- Coffee (B8)
- Long (B9)

Selectable from the beverage selection menu (B3):

- AMERICANO

- Preparation begins. An image of the selected beverage appears on the display, together with a progress bar which gradually fills as preparation proceeds.

Please note:

- While the machine is making coffee, delivery can be interrupted at any moment by pressing the selector (B2) corresponding to "✕STOP".

- As soon as delivery has ended, to increase the quantity of coffee in the cup, just press the selector (B2) corresponding to "⊕EXTRA". When the required quantity is reached, press the selector corresponding to "✕STOP".

Once the coffee has been made, the appliance is ready to make the next beverage.

Important! Making LONG coffee:

Halfway through preparation, the message "ADD GROUND COFFEE, MAXIMUM ONE MEASURE" is displayed. Add one level measure of pre-ground coffee and press the selector (B2) corresponding to "✓ OK".

Please note!

- Various alarm messages could be displayed while using the appliance (FILL TANK, EMPTY GROUNDS CONTAINER, ETC.). Their meaning is explained in section "20. Displayed messages".
- For hotter coffee, see section "7.6 Tips for a hotter coffee".
- If "Energy Saving" mode is active, you may have to wait a few seconds before the first coffee is delivered.

7.5 Adjusting the coffee mill

The coffee mill is set by default to prepare coffee correctly and should not require regulating initially.

However, if after making the first few coffees you find that the coffee is either too weak and not creamy enough or delivery is too slow (a drop at a time), this can be corrected by adjusting the grinding adjustment dial (A5) (fig. 9).

Please note!

The grinding adjustment dial must only be turned when the coffee mill is in operation during the initial phase of coffee preparation.



If the coffee is delivered too slowly or not at all, turn one click clockwise towards 7. For fuller bodied creamier coffee, turn one click anticlockwise towards 1 (do not turn more than one click at a time otherwise the coffee could be delivered

a drop at a time).

These adjustments will only be evident after at least 2 cups of coffee have been delivered. If this adjustment does not obtain the desired result, turn the dial another click.

7.6 Tips for a hotter coffee

For hotter coffee, you should:

- perform a rinse cycle by selecting the "Rinsing" function in the settings menu (section "6.1 Rinsing ☕");
- warm the cups with hot water using the hot water function (see section "9. Delivering hot water");
- increase the coffee temperature in the settings menu "⚙️" (B5) (see section "6.7 Coffee temperature ☕").

8. MAKING CAPPUCCINOS AND MILK-BASED COFFEES

Please note!

- To avoid milk with poor froth or large bubbles, always clean the milk container lid (D2) and hot water connection nozzle (A9) as described in sections "8.4 Cleaning the milk container after use", "14.10 Cleaning the milk container" and "14.11 Cleaning the hot water/steam connection nozzle".

8.1 Filling and attaching the milk container



- Remove the lid (D2) (fig. 13);
- Fill the milk container (D3) with a sufficient quantity of milk, not exceeding the MAX level marked on the container (fig. 14). Each mark on the side of the container corresponds to about 100 ml of milk;

Please note!

- For a denser more even froth, you must use skimmed or partially skimmed milk at refrigerator temperature (about 5°C).
 - If "Energy Saving" mode is enabled, you may have to wait a few seconds before the beverage is delivered.
- Make sure the milk intake tube (D4) is correctly inserted in the bottom of the milk container lid (fig. 15);
 - Place the lid back on the milk container;
 - If present, extract the hot water/steam spout (C6) by pressing the release button (C7) (fig. 16);
 - Attach the milk container (D) to the connection nozzle (A9) (fig. 17) and push as far as it will go. The machine emits a beep (if the beep function is enabled);
 - Place a sufficiently large cup under the coffee spouts (A8) and frothed milk spout (D5). Adjust the length of the milk spout. To move it nearer the cup, simply pull it downwards (fig. 18).
 - Follow the instructions below for each function.

8.2 Adjusting the amount of froth

Turn the froth adjustment dial (D1) to adjust the amount of froth on the milk delivered while making cappuccinos and milk-based coffees.

Dial position	Description	Recommended for...
	NO FROTH	HOT MILK (not frothed) / CAFFELATTE
	MIN. FROTH	LATTE MACCHIATO/ FLAT WHITE
	MAX. FROTH	CAPPUCCINO / CAPPUCCINO+ / CAPPUCCINO MIX / ESPRESSO MACCHIATO / HOT MILK (frothed)

8.3 Making cappuccinos and milk-based coffees automatically

- Fill the milk container (D) and attach it as described above.
- Select the required beverage:

Directly selected beverages:



- Cappuccino (B14)
- Latte Macchiato (B13)
- Milk (latte caldo) (B12)

Selectable from the beverage selection menu (B3):

- CAPPUCCINO+ • FLAT WHITE
- CAPPUCCINO MIX • ESPRESSO MACCHIATO
- CAFFELATTE

- A message on the display (B1) instructs you to turn the froth adjustment dial (D1) according to the froth required by the original recipe. Turn the dial on the milk container lid (D2).
- After a few seconds, preparation begins automatically and an image of the selected beverage appears on the display, together with a progress bar which gradually fills as preparation progresses.

Please note! general indications when preparing all milk-based beverages

- " ESC": press to interrupt preparation completely and go back to the homepage.
- " STOP ": press to interrupt milk or coffee delivery and move on to the next delivery (if applicable) to complete the beverage.
- At the end of delivery, to increase the quantity of coffee in the cup, press " EXTRA".
- Preparation of each coffee can be customised (see sections "12. Customising the beverages " and "13. Memorising your personal profile").
- Do not leave the milk container out of the refrigerator for long periods. The warmer the milk (5°C is ideal), the poorer the quality of froth produced.

Once the coffee has been made, the appliance is ready to make the next beverage.

8.4 Cleaning the milk container after use

Each time you use a milk function, "TURN MILK FROTH ADJUSTMENT DIAL TO CLEAN POSITION" appears on the display and the milk frother lid must be cleaned:

- Leave the milk container (D) in the machine (you do not need to empty it);
- Place a cup or other recipient under the frothed milk spout (fig. 20);
- Turn the froth adjustment dial (D1) to "CLEAN" (fig. 19). "CLEANING UNDERWAY RECIPIENT UNDER SPOUT" appears on the display (B1) together with a bar which gradually fills as cleaning progresses. Cleaning stops automatically;

- Turn the dial back to one of the froth selections;
- Remove the milk container and always clean the steam connection nozzle (A9) with a sponge (fig. 21).

Please note!

- To prepare a number of cappuccinos or milk-based coffees, clean the milk container after you have prepared the last beverage only. To proceed with making the next beverages, when the "CLEAN message is displayed, press the selector corresponding to "↶ESC".

If you do not clean the milk container, the  symbol appears on the display to remind you that it needs cleaning.

- The milk container can be kept in the refrigerator.
- In some cases, before cleaning you must wait for the appliance to heat up.

9. DELIVERING HOT WATER

- Make sure the hot water/steam spout (C6) is attached correctly to the hot water/steam connection nozzle (A9);
- Place a container under the spout (as close as possible to avoid splashes);
- Press the selector (B2) corresponding to the "☰☪" symbol (B3) to enter the menu;
- Press the selector corresponding to the "NEXT>" symbol until "HOT WATER" is displayed;
- Press the selector corresponding to "HOT WATER". The corresponding image appears on the display (B1), together with a progress bar which fills gradually as preparation proceeds;
- The machine delivers hot water, then delivery stops automatically. To interrupt hot water delivery manually, press the selector corresponding to "XSTOP" again.

Please note!

- If "Energy Saving" mode is active, you may have to wait a few seconds before hot water is delivered.
- Preparation of each coffee can be customised (see sections "12. Customising the beverages" and "13. Memorising your personal profile").

10. STEAM DELIVERY

- Make sure the hot water/steam spout (C6) is attached correctly to the hot water/steam connection nozzle (A9);
- Fill a container with the liquid to be heated or frothed and immerse the hot water/steam spout in the liquid;
- Press the selector (B2) corresponding to the "☰☪" symbol (B3) to enter the menu;
- Press the selector (B2) corresponding to the "NEXT>" symbol until "STEAM" appears on the display;
- Press the selector corresponding to "STEAM". The corresponding image appears on the display (B1), together with a progress bar which fills gradually as preparation proceeds

and after a few seconds, steam to heat the liquid is delivered from the cappuccino maker;

- When the required temperature or froth level is obtained, interrupt steam delivery by pressing the selector corresponding to "XSTOP".

Important!

Always stop steam delivery before extracting the container containing the liquid to avoid burns from splashes.

Please note!

If "Energy Saving" mode is active, you may have to wait a few seconds before the hot water is delivered.

10.1 Tips for using steam to froth milk

- When choosing the size of the container, bear in mind that the liquid doubles or triples in volume.
- For a richer denser froth, use skimmed or partially skimmed milk at refrigerator temperature (about 5°C).
- For a creamier froth, rotate the container with slow movements in an upward direction.
- To avoid milk with poor froth or large bubbles, always clean the spout (C6) as described in the following section.

10.2 Cleaning the hot water/steam spout after use

Always clean the hot water/steam spout (C6) after use to avoid the build-up of milk residues and prevent it from clogging.

- Place a container under the hot water/steam spout and deliver a little water (see section "9.  Delivering hot water"). To interrupt hot water delivery manually, press the selector (B2) corresponding to "XSTOP".
- Wait a few minutes for the hot water/steam spout to cool down, then extract (fig. 16) by pressing the release button (C7). Hold the spout with one hand and with the other, turn the cappuccino maker and pull it downwards (fig. 22).
- Also remove the steam connection nozzle by pulling it downwards (fig. 23).
- Check the hole in the connection nozzle is not blocked. If necessary, clean using a toothpick.
- Wash all parts of the spout thoroughly with a sponge and warm water.
- Insert the connection nozzle and cappuccino maker on the spout by pushing them upwards and turning them clockwise until they are attached.

11. TEA FUNCTION

- Make sure the hot water/steam spout (C6) is attached correctly to the hot water/steam connection nozzle (A9);
- Put a tea bag in the cup, then place the cup under the spout (as close as possible to avoid splashes);

- From the homepage, select the required quantity of water by pressing the selector (B2) corresponding to "QUANTITY" (B11);
- Press the selector (B2) corresponding to the  symbol (B3) to enter the menu;
- Press the selector (B2) corresponding to the "NEXT>" symbol until "TEA FUNCTION" appears on the display;
- Select the required water temperature by pressing the selector corresponding to the required tea; each tea (white, green, oolong or black) corresponds to a specific water temperature. The corresponding image appears on the display (B1), together with a progress bar which fills gradually as preparation proceeds;
- The machine delivers the chosen quantity of hot water, then delivery stops automatically. To interrupt manually, press the selector corresponding to "X STOP".

i Please note!

- If "Energy Saving" mode is active, you may have to wait a few seconds before the hot water is delivered.
- The quantity of water in the cup can be customised (see sections "12. Customising the beverages" and "13. Memorising your personal profile").
- Delivery can be stopped at any moment by pressing "X STOP";
- As soon as delivery has ended, to increase the quantity of water in the cup, just press "+ EXTRA". When the required quantity is reached, press "X STOP".

12. CUSTOMISING THE BEVERAGES

The aroma (when required) and quantity of the drinks can be customised.

- Make sure the profile (B4) for which you want to customise the beverage is active. You can select "MY" beverages for each of the 6 profiles;
- From the homepage, press the selector (B2) corresponding to  (B6);
- Select the beverage you want to customise (a directly selected beverage or from the beverages selection menu - B3) to enter the customising screen. The relative accessories must be inserted;
- (Beverages with coffee only) "CHOOSE COFFEE AROMA": Select the required aroma by pressing the selection arrows corresponding to "-" or "+" and press the selector corresponding to "✓ OK";
- "COFFEE (OR WATER) QUANTITY, STOP TO SAVE": Preparation begins and the appliance displays the quantity customising screen in the form of a vertical bar. The star alongside the bar represents the current quantity.
- When the quantity reaches the minimum quantity you can set, "X STOP" appears on the display (B1).

- When the required quantity is reached, press the selector corresponding to "X STOP".
- "SAVE NEW SETTINGS?": Press the selector corresponding to "✓ OK" to save (or the selector corresponding to "↶ ESC" to cancel).

The appliance confirms if the values have been saved or not (depending on the previous selection). Press the selector corresponding to "✓ OK".

The appliance goes back to the homepage.

Please note!

- Cappuccinos and milk-based coffees:** the coffee aroma is saved first, followed by the quantity of first milk, then coffee;
- Americano:** the coffee aroma is saved first, followed by the quantity of first coffee, then hot water;
- Hot water:** the appliance delivers hot water. Press the selector (B2) corresponding to "X STOP" to save the required quantity.
- You can also customise the beverages by connecting with the DeLonghi Coffee Link App.
- Press "↶ ESC" to exit programming. The values will not be saved.

Beverage quantity table		
Beverage	Standard quantity	Programmable quantity
ESPRESSO	≈40 ml	≈20-80 ml
LONG	≈160 ml	≈115-250 ml
COFFEE	≈180 ml	≈100-240 ml
DOPPIO+	≈120 ml	≈80-180 ml
AMERICANO	≈150 ml	≈70-480 ml
TEA	≈150 ml	≈30-420 ml
HOT WATER	≈250 ml	≈20-420 ml

13. MEMORISING YOUR PERSONAL PROFILE

The appliance allows you to memorise 6 different profiles, each associated with a different icon.

The customised "MY" beverages "AROMA" and "QUANTITY" values are saved in each profile (see section "12. Customising the beverages"). The order in which all the beverages are displayed is based on the frequency of selection.

To select or enter a profile, press on the profile currently in use (B4), press the selector (B2) corresponding to the "NEXT>" symbol until the required profile is displayed, then press on the profile.

Please note!

- "GUEST" (GUEST) profile: select this profile to deliver beverages with the default settings. The  function is not active.

- You can rename your personal profile by connecting with the DeLonghi Coffee Link App (only the first three characters will be displayed).
- To customise the profile icon, see section "6.15 Personalizza profilo".

14. CLEANING

14.1 Cleaning the machine

The following parts of the machine must be cleaned regularly:

- the appliance's internal circuit;
- coffee grounds container (A10);
- drip tray (A14), condensate tray (A21) and drip tray grille (A13);
- water tank (A16);
- coffee spouts (A8);
- pre-ground coffee funnel (A4);
- infuser (A19), accessible after opening the infuser door (A18);
- milk container (D);
- hot water/steam connection nozzle (A9);
- control panel (B).

Important!

- Do not use solvents, abrasive detergents or alcohol to clean the coffee machine. With De'Longhi superautomatic coffee machines, you need not use chemical products to clean the machine.
- None of the components of the appliance can be washed in a dishwasher with the exception of the drip tray grille (A13) and milk container (D).
- Do not use metal objects to remove encrustations or coffee deposits as they could scratch metal or plastic surfaces.

14.2 Cleaning the machine's internal circuit

If the appliance is not used for more than 3/4 days, before using it again, we strongly recommend switching it on and:

- performing 2/3 rinse cycles by selecting the "Rinse" function (section "6.1 Rinsing ");
- delivering hot water for a few seconds (section "9. Delivering hot water").

Please note!

After cleaning, it is normal for the grounds container (A10) to contain water.

14.3 Cleaning the coffee grounds container

When "EMPTY GROUNDS CONTAINER" appears on the display (B1), the grounds container must be emptied and cleaned. The appliance cannot be used to make coffee until you have cleaned the grounds container (A10). Even if not full, the empty grounds container message appears on the display 72 hours after the first coffee has been prepared (To ensure the 72 hours are cal-

culated correctly, the appliance must never be unplugged from the mains supply).

Important! Danger of burns

If you make a number of cappuccinos one after the other, the metal cup tray (A11) becomes hot. Wait for it to cool down before touching it and handle it from the front only.

To clean (with the machine on):

- Remove the drip tray (A14) (fig. 24), empty and clean.
- Empty the grounds container (A10) and clean thoroughly to remove all residues left on the bottom. This can be done using the spatula on the brush (C5) provided.
- Check the red condensate tray (A21) and empty if necessary.

Important!

When removing the drip tray, the grounds container must be emptied, even if it contains few grounds. If this is not done, when you make the next coffees, the grounds container may fill up more than expected and clog the machine.

14.4 Cleaning the drip tray and condensate tray

Important!

The drip tray (A14) is fitted with a level indicator (A12) (red) showing the level of water it contains (fig. 25). Before the indicator protrudes from the cup tray (A11), the drip tray must be emptied and cleaned otherwise the water may overflow the edge and damage the appliance, the surface it rests on or the surrounding area.

To remove the drip tray, proceed as follows:

1. Remove the drip tray and the coffee grounds container (A10) (fig. 24);
2. Remove the cup tray (A11) and drip tray grille (A13), then empty the drip tray and grounds container and wash all components.
3. Check the red condensate tray (A21) and empty if necessary.
4. Put the drip tray complete with grille and grounds container back in the appliance.

14.5 Cleaning the inside of the coffee machine

Danger of electric shock!

Before cleaning internal parts, the machine must be turned off (see section "5. Turning the appliance off") and unplugged from the mains power supply. Never immerse the coffee machine in water.

1. Check regularly (about once a month) that the inside of the appliance (accessible after removing the drip tray - A14) is not dirty. If necessary, remove coffee deposits with the brush (C5) supplied and a sponge.
2. Remove all the residues with a vacuum cleaner (fig. 26).

14.6 Cleaning the water tank

1. Clean the water tank (A16) regularly (about once a month) and whenever you replace the water softener filter (C4) (if provided) with a damp cloth and a little mild washing up liquid. Rinse thoroughly before filling the tank and putting it back in the appliance;
2. Remove the filter (if present) and rinse with running water;
3. Replace the filter (if provided), fill the tank with fresh water and replace the tank;
4. (Models with water softener filter only) Deliver about 100ml of hot water to reactivate the filter.

14.7 Cleaning the coffee spouts

1. Clean the coffee spouts (A8) regularly with a sponge or cloth (fig. 27A);
2. Check that the holes in the coffee spouts are not blocked. If necessary, remove coffee deposits with a toothpick (fig. 27B).

14.8 Cleaning the pre-ground coffee funnel

Check regularly (about once a month) that the pre-ground coffee funnel (A4) is not blocked. If necessary, remove coffee deposits with the brush (C5) supplied.

14.9 Cleaning the infuser

The infuser (A19) must be cleaned at least once a month.

Important!

The infuser may not be extracted when the machine is on.

1. Make sure the machine is correctly turned off (see section "5. Turning the appliance off");
2. Remove the water tank (A16) (fig. 2);
3. Open the infuser door (A18) (fig. 28) on the right side of the appliance;
4. Press the two coloured release buttons inwards and at the same time pull the infuser outwards (fig. 29);
5. Soak the infuser in water for about 5 minutes, then rinse under the tap;

Important!

**RINSE WITH WATER ONLY
NO WASHING UP LIQUID - NO DISH WASHER**

Clean the infuser without using washing up liquid as it could be damaged.

6. Use the brush (C5) to remove any coffee residues left in the infuser housing, visible through the infuser door;
7. After cleaning, replace the infuser by sliding it onto the internal support (fig. 30), then push the PUSH symbol fully in until it clicks into place;

Please note!

If the infuser is difficult to insert, before insertion, adapt it to the right size by pressing the two levers shown in fig. 31.

8. Once inserted, make sure the two coloured buttons have snapped out (fig. 32);
9. Close the infuser door;
10. Put the water tank back.

14.10 Cleaning the milk container

To keep the frother efficient, clean the milk container (D) every two days as described below:

1. Remove the lid (D2);
2. Remove the milk spout (D5) and intake tube (D4) (fig. 33);
3. Turn the froth adjustment dial (D1) anticlockwise to the "INSERT" position (fig. 33) and pull it off upwards;

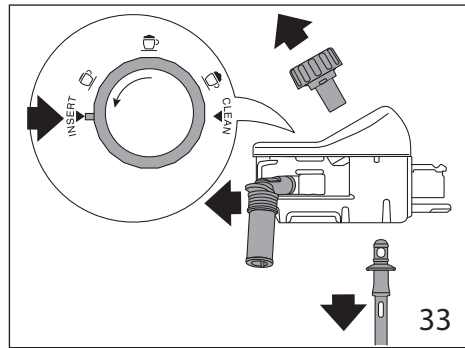

4. Wash all the components thoroughly with hot water and mild washing-up liquid. **All components are dishwasher safe, placing them in the top basket of the dishwasher.**

Make sure there are no milk residues on the hollow and groove under the dial (fig. 34). If necessary, scrape the groove with a toothpick;

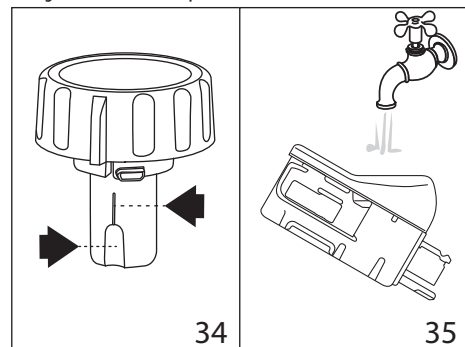

5. Rinse inside the froth adjustment dial seat with running water (fig. 35);
6. Check that the intake tube and spout are not clogged with milk residues;
7. Replace the dial (in correspondence to the word "INSERT"), spout and milk intake tube;

- Place the lid back on the milk container (D3).

14.11 Cleaning the hot water/steam connection nozzle

Each time you prepare milk, clean the connection nozzle (A9) with a sponge to remove milk residues from the gaskets (fig. 21).

15. DESCALING

Important!



- Before use, read the instructions and the labelling on the descaler pack.
- You should use De'Longhi descaler only. Using unsuitable descaler and/or performing descaling incorrectly may result in faults not covered by the manufacturer's guarantee.

Descalc the appliance when "DESCALING NEEDED - PRESS OK TO START (~45min) 

" appears on the display (B1): To descale the appliance immediately, press the corresponding selector (B2) "✓ OK" and follow the instructions from point 3. To descale the appliance later, press the selector (B2) corresponding to "↶ ESC". The  symbol appears on the display to remind you that the appliance needs descaling. (the message appears each time you turn the appliance on).

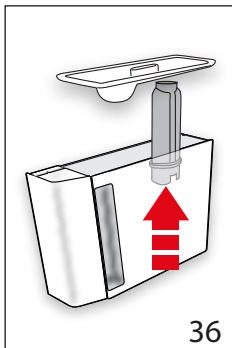
To access the descaling menu:



- Press the selector (B2) corresponding to the  symbol (B5) to enter the menu;
- Press the selector corresponding to  "DESCALE" and follow the instructions on the display;
- "REMOVE WATER SOFTENER FILTER" (fig. 36): extract the water tank (A16), remove the water softener filter (C4) (if present) and empty the water tank. Press the selector corresponding to "NEXT>";

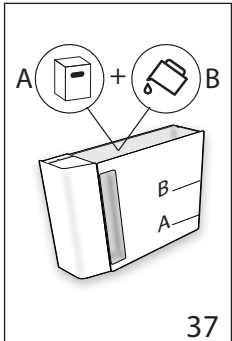

- "DESCALER (LEVEL A) AND WATER (LEVEL B)" (fig. 37); Pour the descaler into the tank up to the level A marked inside the tank (equal to one 100 ml pack), then add

water (one litre) up to level B and put the water tank back. Press the selector corresponding to "NEXT>";

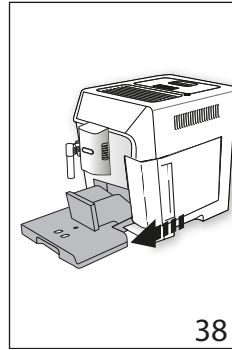

- "EMPTY DRIP TRAY" (fig. 38);
- Remove, empty and replace the drip tray (A14) and grounds container (A10). Press the selector corresponding to "NEXT>";
- "POSITION 2| CONTAINER OK TO START":

Place an empty container with a minimum capacity of 2 litres under the hot water/steam spout (C6) and coffee spouts (A8) (fig. 7);

Important! Danger of burns

Hot water containing acid flows from the hot water/steam and coffee spouts. Take care to avoid contact with splashes of this solution.

- Press the selector corresponding to "✓ OK" to confirm that you have added the descaling solution. "DESCALING UNDERWAY, PLEASE WAIT" is displayed: The descale programme starts and the descaler liquid comes out of the hot water and coffee spouts. A series of rinses is performed automatically to remove all the scale residues inside the coffee machine;
- After about 25 minutes, descaling stops;
- "RINSE AND FILL WATER TANK UP TO MAX LEVEL" (fig. 4): the appliance is now ready to rinse with fresh water. Empty the container used to collect the descaler solution. Extract the water tank, empty, rinse under running water, fill with fresh water up to the MAX level and put back in the appliance;
- "POSITION 2| CONTAINER PRESS OK TO START RINSING": Place the container used to collect the descaler solution empty under the coffee spouts and hot water/steam spout (fig. 7) and press the selector corresponding to "✓ OK";
- Hot water is delivered first from the coffee spouts, then from the hot water/steam spout and "RINSING UNDERWAY" is displayed;
- When the water in the tank has run out, empty the container used to collect the rinsing water;

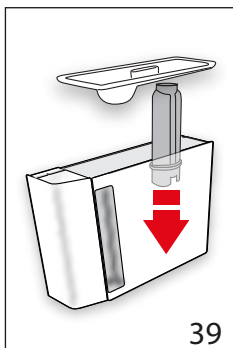

12. (If the filter is installed) "INSERT FILTER INTO ITS HOUSING" (fig. 39). Press the selector corresponding to "NEXT>" and extract the water tank. Replace the water softener filter if removed previously;
13. "RINSE AND FILL WATER TANK UP TO MAX LEVEL" (fig. 4): Fill the tank up to the MAX level with fresh water;

14. "INSERT WATER TANK" (fig. 5): Put the water tank back in the appliance;
15. "POSITION 2I CONTAINER PRESS OK TO START RINSING": Place the container used to collect the descaler solution empty under the hot water/steam spout (fig. 7) and press the selector corresponding to "✓OK";
16. Hot water is delivered from the hot water/steam spout and "RINSING UNDERWAY, PLEASE WAIT" is displayed;
17. "EMPTY DRIP TRAY" (fig. 38): At the end of the second rinse, remove, empty and replace the drip tray (A14) and grounds container (A10). Press the selector corresponding to "NEXT>";
18. "DESCALE COMPLETE": to confirm, press the selector corresponding to "✓OK";
19. "FILL TANK WITH FRESH WATER": empty the container used to collect the rinse water, remove the water tank and fill with fresh water up to the MAX level, then put back in the appliance.

Descaling is complete.

Please note!

- If the descaling cycle is not completed correctly (e.g. no electricity) we recommend repeating the cycle;
- After descaling, it is normal for the grounds container (A10) to contain water.
- If the water tank has not been filled to the MAX level, at the end of descaling, the appliance requests a third rinse to guarantee that the descaler solution has been completely eliminated from the machine's internal circuits. Before starting rinsing, remember to empty the drip tray;
- The appliance may request descaling cycles at very short intervals. This is normal and due to the appliance's advanced control system.

16. SETTING WATER HARDNESS

The "DESCALING NEEDED - PRESS OK TO START (~45MIN)

 message is displayed after a period of time established according to water hardness.



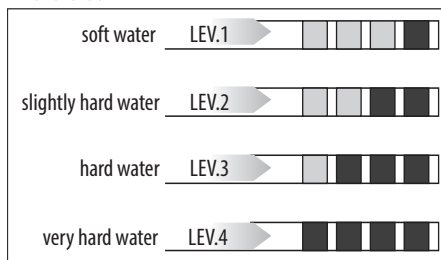

The machine is set by default for a hardness value of "4". The machine can also be programmed according to the hardness of the mains water in the various regions so that the machine needs to be descaled less often.

16.1 Measuring water hardness

1. Remove the "TOTAL HARDNESS TEST" indicator paper (C1) from its pack (attached to the English instructions).
2. Immerse the paper completely in a glass of water for one second.
3. Remove the paper from the water and shake lightly. After about a minute, 1, 2, 3, or 4 red squares form, depending on the hardness of the water. Each square corresponds to one level.



16.2 Setting water hardness

1. Press the selector (B2) corresponding to the  symbol (B5) to enter the menu;
2. Scroll through the menu items by pressing the selector corresponding to "NEXT>" until  "WATER HARDNESS" appears on the display;
3. Press the selector corresponding to  "WATER HARDNESS";
4. "WATER HARDNESS, CURRENT UNDERLINED": Press the selector corresponding to the required level (Level 1 = soft water; Level 4 = very hard water);
4. Press the selector corresponding to  "ESC" to go back to the homepage.

The machine is now reprogrammed with the new water hardness setting.

17. WATER SOFTENER FILTER

Certain models are fitted with a water softener filter (C4). If this is not the case with your model, you are recommended to purchase one from De'Longhi Customer Services.

To use the filter correctly, follow the instructions below.

17.1 Installing the filter

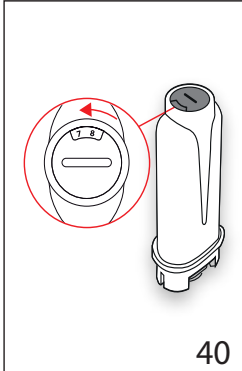

1. Remove the filter (C4) from the packaging;
2. Press the selector (B2) corresponding to the "⚙️" symbol (B5) to enter the menu;
3. Scroll through the menu items by pressing the selector corresponding to "NEXT>" until "WATER FILTER" appears on the display;
4. Press the selector corresponding to "WATER FILTER";
5. "TURN DATE INDICATOR TO NEXT 2 MONTHS" (fig. 40): turn the date indicator disk until the next two months of use are displayed. Press the selector corresponding to "NEXT>";

Please note

The filter lasts about two months if the appliance is used normally. If the coffee machine is left unused with the filter installed, it will last a maximum of 3 weeks.

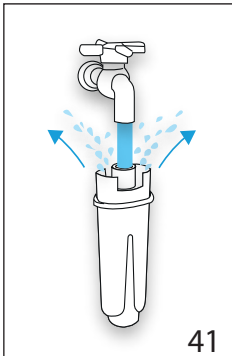

6. "RUN WATER INTO FILTER HOLE UNTIL IT COMES OUT" (fig. 41): To activate the filter, run tap water through the hole in the filter as shown in the figure until water comes out of the openings at the side for more than a minute. Press the selector corresponding to "NEXT>";
7. Extract the tank (A16) from the appliance and fill with water.

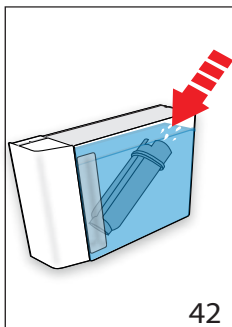

8. "IMMERSE FILTER TO EXPEL AIR BUBBLES" (fig. 42): Insert the filter in the water tank and immerse it completely for about ten seconds, sloping it and pressing it lightly to enable the air bubbles to escape. Press the selector corresponding to "NEXT>";

9. "INSERT FILTER IN HOUSING": Insert the filter in the filter housing (A17-fig. 39) and press as far as it will go. Press the selector corresponding to "NEXT>";
10. "INSERT WATER TANK": Close the tank with the lid (A15), then put the tank back in the machine (fig. 5);
11. "POSITION 0.5L CONTAINER, PRESS OK TO ENABLE FILTER" (fig. 7): Place the container under the hot water/steam spout (C6) and press "✓ OK". Delivery begins and stops automatically.

The filter is now active and you can use the coffee machine.

17.2 Replacing the filter

Replace the filter (C4) when "⚠️ REPLACE WATER FILTER, PRESS OK TO START" appears on the display (B1): To replace the filter immediately, press the selector (B2) corresponding to "✓ OK" and follow the instructions from point 5.

To replace the filter later, press the selector corresponding to "↶ ESC". The ⚠️ symbol appears on the display to remind you that the filter needs replacing. To replace, proceed as follows:

1. Extract the tank (A16) and exhausted filter;
2. Remove the new filter from the packaging;
3. Press the selector (B2) corresponding to the "⚙️" symbol (B5) to enter the menu;
4. Press the selector corresponding to "WATER FILTER";
5. Press the selector corresponding to "REPLACE WATER FILTER";
6. Follow the operations described in the previous section from point 5.

The filter is now active and you can use the coffee machine.

Please note!

After two months (see date indicator) or when the appliance has not been used for 3 weeks, you should replace the filter even if the message has not yet been displayed.

17.3 Removing the filter

If you want to use the appliance without the filter (C4), you must remove it and notify the appliance of its removal. Proceed as follows:

1. Extract the tank (A16) and exhausted filter;
2. Press the selector (B2) corresponding to the "⚙️" symbol (B5) to enter the menu;
3. Press the selector corresponding to "WATER FILTER";
4. Press the selector corresponding to "REMOVE WATER FILTER";
5. "⚠️ CONFIRM FILTER REMOVAL!": to confirm press the selector corresponding to "✓ OK" (to go back to the

settings menu, press the selector corresponding to "ESC");

6.  "FILTER REMOVED": the change has been saved.
Press "✓OK" to go back to the homepage.

Please note!

After two months (see date indicator) or when the appliance has not been used for 3 weeks, you should replace the filter even if the message has not yet been displayed.



18. TECHNICAL DATA



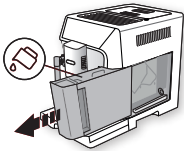
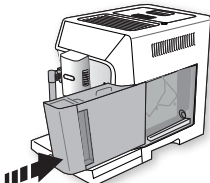

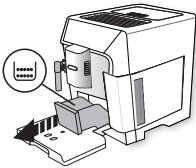
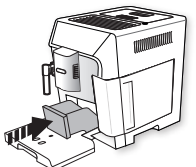
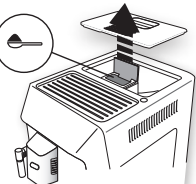
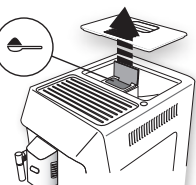
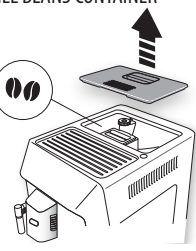
Voltage:	220-240 V~ 50-60 Hz max. 10 A
Power:	1450 W
Pressure:	1.9 MPa (19 bars)
Water tank capacity:	2 l
Size LxDxH:	260x470x360 mm
Cord length:	1200 mm
Weight:	11.4 kg
Beans container capacity:	380 g
Frequency	2400 - 2483,5 MHz
Max transmit power	10 mW

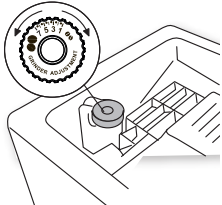

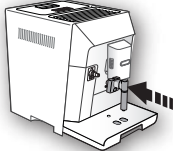
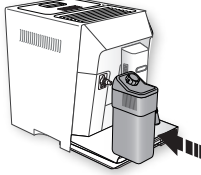
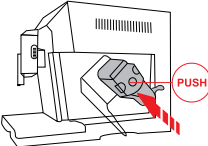

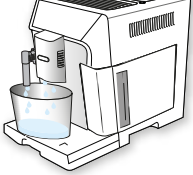
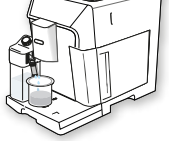

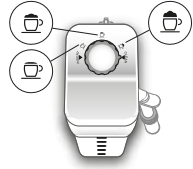



19.  DISPLAYED MESSAGES

DISPLAYED MESSAGE	POSSIBLE CAUSE	REMEDY
FILL TANK WITH FRESH WATER 	Insufficient water in the tank (A16).	Fill the tank with water and/or insert it correctly, pushing it as far as it will go until it clicks into place.
INSERT WATER TANK 	The tank (A16) is not correctly in place.	Insert the tank correctly and press as far as it will go.

DISPLAYED MESSAGE	POSSIBLE CAUSE	REMEDY
<p>EMPTY GROUNDS CONTAINER</p> 	<p>The grounds container (A10) is full.</p>	<p>Empty the grounds container and drip tray (A14), clean and replace. Important: when removing the drip tray, the grounds container must be emptied, even if it contains few grounds. If this is not done, when you make the next coffees, the grounds container may fill up more than expected and clog the machine.</p>
<p>INSERT GROUNDS CONTAINER</p> 	<p>After cleaning, the grounds container (A10) has not been replaced.</p>	<p>Remove the drip tray (A14) and insert the grounds container.</p>
<p>ADD GROUND COFFEE MAX. ONE MEASURE</p>  <p>↶ ESC</p>	<p>The "pre-ground coffee" function has been selected without placing any pre-ground coffee in the funnel (A4).</p>	<p>Place pre-ground coffee in the funnel (fig. 12) and repeat delivery</p>
<p>ADD GROUND COFFEE MAX. ONE MEASURE</p>  <p>✓ OK</p>	<p>A LONG coffee with pre-ground coffee has been requested</p>	<p>Place pre-ground coffee in the funnel (A4) (fig. 12) and press the selector corresponding to "✓ OK" to continue and complete delivery.</p>
<p>FILL BEANS CONTAINER</p>  <p>↶ ESC</p>	<p>The coffee beans have run out. The pre-ground coffee funnel (A4) is clogged.</p>	<p>Fill the beans container(A3) (fig. 10). Empty the funnel with the help of the brush (C5) as described in section "14.8 Cleaning the pre-ground coffee funnel".</p>

DISPLAYED MESSAGE	POSSIBLE CAUSE	REMEDY
<p data-bbox="125 161 334 211">GROUND TOO FINE. ADJUST MILL</p>  <p data-bbox="125 431 205 464">↶ ESC</p>	<p data-bbox="369 161 717 216">The grinding is too fine and the coffee is delivered too slowly or not at all.</p> <p data-bbox="369 439 717 513">If the water softener filter (C4) is present, an air bubble may have been released inside the circuit, obstructing delivery.</p>	<p data-bbox="736 161 1084 422">Repeat coffee delivery and turn the grinding adjustment dial (A5) (fig. 9) one click clockwise towards 7 while the coffee mill is in operation. If after making at least 2 coffees delivery is still too slow, repeat the correction procedure, turning the grinding adjustment dial another click until delivery is correct (see section "7.5 Adjusting the coffee mill"). If the problem persists, make sure the water tank (A16) is fully inserted.</p> <p data-bbox="736 439 1084 513">Insert the hot water/steam spout (C6) in the appliance and deliver a little water until the flow becomes regular.</p>
<p data-bbox="125 530 334 579">SELECT A Milder TASTE OR REDUCE COFFEE AMOUNT</p>  <p data-bbox="125 700 205 733">↶ ESC</p>	<p data-bbox="369 530 603 555">Too much coffee has been used.</p>	<p data-bbox="736 530 1084 637">Select a milder taste by pressing the selector (B2) corresponding to "AROMA" (B10) or reduce the quantity of ground coffee (maximum 1 measure).</p>
<p data-bbox="125 751 290 776">INSERT WATER SPOUT</p> 	<p data-bbox="369 751 699 802">The hot water spout (C6) is not inserted or is inserted incorrectly</p>	<p data-bbox="736 751 1036 776">Insert the water spout as far as it will go.</p>
<p data-bbox="125 996 314 1020">INSERT MILK CONTAINER</p> 	<p data-bbox="369 996 717 1020">The milk container (D) is not inserted correctly.</p>	<p data-bbox="736 996 1084 1047">Insert the milk container as far as it will go (fig. 17).</p>
<p data-bbox="125 1240 326 1265">INSERT INFUSER ASSEMBLY</p> 	<p data-bbox="369 1240 717 1291">The infuser (A19) has not been replaced after cleaning.</p>	<p data-bbox="736 1240 1084 1291">Insert the infuser as described in section "14.9 Cleaning the infuser".</p>



DISPLAYED MESSAGE	POSSIBLE CAUSE	REMEDY
<p>WATER CIRCUIT EMPTY PRESS OK TO START</p>  <p>✓ OK</p>	<p>The water circuit is empty</p>	<p>Press the selector corresponding to "✓ OK" to deliver water from the spout (C6) until it flows out normally. If the problem persists, make sure the water tank (A16) is fully inserted.</p>
<p>PRESS OK TO CLEAN OR TURN DIAL</p>  <p>✓ OK</p>	<p>The milk container has been inserted with the froth adjustment dial (D1) in the "CLEAN" position.</p>	<p>To proceed with the CLEAN function, press the selector corresponding to "✓ OK", or turn the froth adjustment dial to one of the milk positions.</p>
<p>TURN DIAL TO CLEAN POSITION</p>  <p>↶ ESC</p>	<p>Milk has been delivered recently and the tubes inside the milk container (D) must be cleaned.</p>	<p>Turn the froth adjustment dial (D1) to CLEAN (fig. 19).</p>
<p>TURN FROTH ADJUSTMENT DIAL</p> 	<p>The milk container has been inserted with the froth adjustment dial (D1) in the "CLEAN" position.</p>	<p>Turn the dial to the required froth position.</p>
<p>DESCALING NEEDED PRESS OK TO START (~45MIN)</p>  <p>↶ ESC ✓ OK</p>	<p>The machine must be descaled.</p>	<p>Press the selector corresponding to "✓ OK" to start descaling or "↶ ESC" to descale later. The descaling procedure described in section "15. Descaling" needs to be performed.</p>

DISPLAYED MESSAGE	POSSIBLE CAUSE	REMEDY
REPLACE WATER FILTER PRESS OK TO START   	The water softener filter (C4) is exhausted.	Press the selector corresponding to “√OK” to replace or remove the filter, or ESC to carry out the procedure later. Follow the instructions in section “17. Water softener filter”.
GENERAL ALARM: USER MANUAL / APP 	The inside of the appliance is very dirty.	Clean the inside of the appliance thoroughly, as described in section “14. Cleaning”. If the message is still displayed after cleaning, contact a customer service centre.
	The appliance needs descaling and/or the filter (C4) must be replaced.	The descaling procedure described in section “15. Descaling” needs to be performed and/or the filter needs replacing or removing as described in section “17. Water softener filter”.
	The tubes inside the milk container (D) must be cleaned.	Turn the froth adjustment dial (D1) to CLEAN (fig. 19).
	The filter (C4) must be replaced.	Replace the filter or remove it as described in section “17. Water softener filter”.
	The machine must be descaled.	The descaling procedure described in section “15. Descaling” needs to be performed. • The appliance may request descaling cycles at very short intervals. This is normal and due to the appliance’s advanced control system.
	Energy saving is enabled.	To disable energy saving, proceed as described in section “6.6 Energy saving  ”.
	The appliance is connected to a device via bluetooth.	
CLEANING UNDERWAY PLEASE WAIT	The appliance has detected impurities in its internal circuits.	Wait for the appliance to be ready for use again and reselect the required beverage. Contact Customer Services if the problem persists.

20. TROUBLESHOOTING

Below is a list of some of the possible malfunctions.

If the problem cannot be resolved as described, contact Customer Services.

PROBLEM	POSSIBLE CAUSE	REMEDY
The coffee is not hot.	The cups were not preheated.	Warm the cups by rinsing them with hot water (Please note! you can use the hot water function).
	The infuser has cooled down because 2/3 minutes have elapsed since the last coffee was made.	Before making the coffee, heat the infuser by rinsing using the rinse function (see section "6.1 Rinsing  ").
	A low coffee temperature is set.	Set a hotter coffee temperature in the menu (see section "6.7 Coffee temperature  ").
The coffee is weak or not creamy enough.	The coffee is ground too coarsely.	Turn the grinding adjustment dial (A5) one click anticlockwise towards 1 while the coffee mill is in operation (fig. 10). Continue one click at a time until coffee delivery is satisfactory. The effect is only visible after delivering 2 coffees (see section "7.5 Adjusting the coffee mill").
	The coffee is unsuitable.	Use coffee for espresso machines.
The coffee is delivered too slowly or a drop at a time.	The coffee is ground too finely.	Turn the grinding adjustment dial (A5) one click anticlockwise towards 7 while the coffee mill is in operation (fig. 9). Continue one click at a time until coffee delivery is satisfactory. The effect is only visible after delivering 2 coffees (see section "7.5 Adjusting the coffee mill").
Coffee does not come out of one or both of the spouts.	The coffee spouts (A8) are blocked.	Clean the spouts with a toothpick (fig. 27B).
The appliance will not make coffee	The appliance has detected impurities in its internal circuits. "Cleaning underway" is displayed.	Wait for the appliance to be ready for use again and reselect the required beverage. Contact Customer Services if the problem persists.
The appliance does not come on	It is not plugged into the mains socket.	Plug into the mains socket (fig. 1).
The infuser cannot be extracted	The appliance has not been turned off correctly	Turn the appliance off by pressing the  button (A7) (see section "5. Turning the appliance off").
At the end of descaling, the appliance requests a third rinse	During the two rinse cycles, the water tank (A16) has not been filled to the MAX level	Follow the instructions displayed by the appliance, but first empty the drip tray (A14) to avoid the water overflowing.

PROBLEM	POSSIBLE CAUSE	REMEDY
The milk does not come out of the milk spout (D5)	The lid (D2) of the milk container (D) is dirty	Clean the milk container lid as described in section "14.10 Cleaning the milk container".
The milk contains large bubbles and squirts out of the milk spout (D5) or there is little froth	The milk is not cold enough or is not semi-skimmed or skimmed.	Use skimmed or semi-skimmed milk at refrigerator temperature (about 5° C). If the result is not as you wished, try changing brand of milk.
	The froth adjustment dial (D1) is incorrectly adjusted.	Adjust following the instructions in section "8. making cappuccinos and milk-based coffees".
	The milk container lid (D2) or froth adjustment dial (D1) is dirty	Clean the milk container lid and froth adjustment dial as described in section "14.10 Cleaning the milk container".
	The hot water/steam connection nozzle (A9) is dirty	Clean the connection nozzle as described in section "14.11 Cleaning the hot water/steam connection nozzle".
The cup warmer is hot, even though it has been disabled	A number of beverages have been prepared in rapid succession	
The machine emits noises or small puffs of steam while not in use	The machine is ready for use, or has recently been turned off, and condensate is dripping into the hot vaporiser	This is part of normal operation. To limit the phenomenon, empty the drip tray.