

manual

leva

The Leva is the newest 2.0 professional lever machine in the market, bringing the lever concept and design to the next level. The Leva is dedicated to coffee brewing radicals, offering a groundbreaking lever technology for those aiming to pilot a solid, mechanical, heavy-duty yet safe, reliable and user-friendly machine.



la marzocco

handmade in florence

leva

Operating Manual V1.0 - 06/2017
MAN.19.1

Chapters

1. General Warnings and Safety Specifications	page 3
2. Definition of Available Models	page 7
3. Installation	page 12
4. Machine Operation and Coffee Preparation	page 22
5. Dispensing Steam and Hot Water	page 28
6. Maintenance and Periodic Cleaning Operations	page 29
7. De-commissioning and Demolition	page 32
8. Mandatory Maintenance and Check-up Operations	page 33
9. Software Programming Guide	page 34



la marzocco

handmade in florence

La Marzocco S.r.l.

Via La Torre 14/H
Località La Torre
50038 Scarperia e San Piero
(Firenze) - ITALIA

www.lamarzocco.com
info@lamarzocco.com

T: +39 055 849 191
F: +39 055 849 1990

certifications available:



1. General Warnings and Safety Specifications

WARNING

This machine is for professional use only and should be installed in locations where its use and maintenance is restricted to trained personnel. Children are forbidden to operate or play with the machine.

WARNING

The Coffee machine must be placed in a horizontal position on a counter higher than 80 cm from the ground, and anyway suitable for the height of the personnel in charge.

WARNING

This machine is not suitable for outdoor use. Jets of water should not be used to clean the machine, nor should it be placed where water jets are used.

WARNING

As already mentioned in the preceding notes, the manufacturer shall not be held responsible for damage to objects, animals and/or people whenever the machine has not been installed according to the instructions contained in this manual, and is not used to do what it was designed for (i.e. preparing coffee and hot drinks).

WARNING

Make sure that the counter height and the machine location allow operators to firmly grasp the brew lever grip.

1) Important safeguards

- The weighted sound pressure level of the machine is lower than 70dBA.
- Use, cleaning and maintenance of this coffee machine are realized by people (including children more than 8 years of age) with reduced physical, sensory or mental capabilities, or lack of experience and knowledge, as long as they have been given supervision or instructions concerning the use of the appliance by a person responsible for their safety and if they understand dangers.
- Children should be

supervised to ensure that they do not play with the appliance.

- Keep the appliance and its cord out of the reach of children less than 8 years of age.

2) This operating manual is an integral and essential part of the product and must be supplied to users. Users are asked to read the enclosed warnings and cautions carefully, as they provide valuable information concerning safety during installation, operation and maintenance. This manual must be kept in a safe place and be available for consultation to new and experienced users alike.

3) Ensure product's integrity by inspecting the packaging,

making sure it presents no signs of damage which might have affected the enclosed machine.

4) Check the machine's integrity after having carefully removed the packaging.

Note: In case of doubt, do not go on any further and contact your dealer or retailer immediately. They will send out specialized personnel authorized to perform service on the espresso machine.

5) Packaging (boxes, plastic bags, foam parts and whatever else) must not be left around within easy reach of children, due to the potential danger it represents, nor be discarded in the environment.

6) Check to see that data on the rating plate corresponds to those of the main electrical supply which the machine

will be hooked up to.

7) The equipment must be installed to comply with the applicable federal, state or local electrical and plumbing codes. The installation also must comply to the manufacturer's instructions, and must be performed by qualified and authorized personnel.

8) Incorrect installation may cause for injury/damages to people, animals or objects, for which the manufacturer shall not be held responsible.

9) Safe electrical operation of this device will be achieved only when the connection to the power outlet has been completed correctly and in observance of all local, national, and international electrical codes and safety

regulations, and particularly by grounding the unit. Make sure grounding has been done properly as it represents a fundamental safety requirement. Ensure qualified personnel check such connection.

10) Furthermore, you must ensure that the capacity of the available electrical system is suitable for the maximum power consumption indicated on the espresso machine.

11) We do not recommend using adapters, multiple plugs and/or extension cords. If you cannot avoid using them, make sure that they are exclusively of the kind which conforms to local, national, and international electrical codes and safety regulations, being careful not to exceed

the power and current ratings indicated on such adapters and extension cords.

12) This device must be used exclusively for the functions it has been designed and built for. Any other application is inappropriate and dangerous.
The manufacturer shall not be held responsible for any damages caused by improper and/or irrational use.

This machine should not be installed in kitchens.

13) Using any electrical device requires that certain fundamental rules be observed. In particular:

- do not touch the device with wet or humid hands and feet;
- do not use the device while having no shoes on your feet;

- do not use extension cords in bath or shower rooms;
- do not unplug the device from the power outlet by pulling on the power supply cable;
- do not expose the device to atmospheric agents (rain, sun, etc.);
- do not allow children or untrained people to use this device;
- do not clean the control panel with a wet cloth since it is not watertight.

14) Before carrying out any maintenance and/or cleaning operations, turn the main switch, which is located on the front left of the machine, to the “0” or “OFF” position, and disconnect the machine from the electrical network by unplugging the cord or

by switching off the relative circuit breaker. For any cleaning operation, follow exclusively the instructions contained in this manual.

15) In case the machine is operating in a faulty manner or breaks down, disconnect it from the electrical network (as described in the preceding point) and close the water supply valve. Do not attempt to repair it. Contact a qualified and authorized professional to perform any repair. Any repairs must be performed exclusively by the manufacturer or by an authorized centre using only original parts. Non compliance with the above could compromise the safe operation of the machine.

16) You should plan to

make use of an omnipolar connector during installation, as required by local, national, and international electrical codes and regulations.

17) In order to avoid dangerous overheating problems, it is recommended that the power supply cable be fully unfurled.

18) Do not obstruct air intake and exhaust grilles and, in particular, do not cover the cup warmer tray with cloths or other items.

19) The machine's power supply cable must not be replaced by users. In case the power supply cable becomes damaged, shut off the machine and disconnect the machine from the electrical network by switching off the relative circuit breaker and

close off the water supply; to replace the power supply cord, contact qualified professionals exclusively.

20) Dimensions and weights common to all LEVA machines

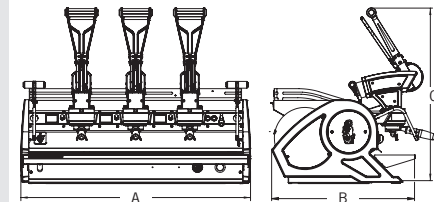

LEVA	2 groups	3 groups
A [mm]	818	1018
B [mm]	645	645
C [mm]	776	776
WEIGHT [kg]	99	129

2. Definition of Available Models

This operating manual refers exclusively to the following models, of our own manufacture:
LEVA S, model 3 groups

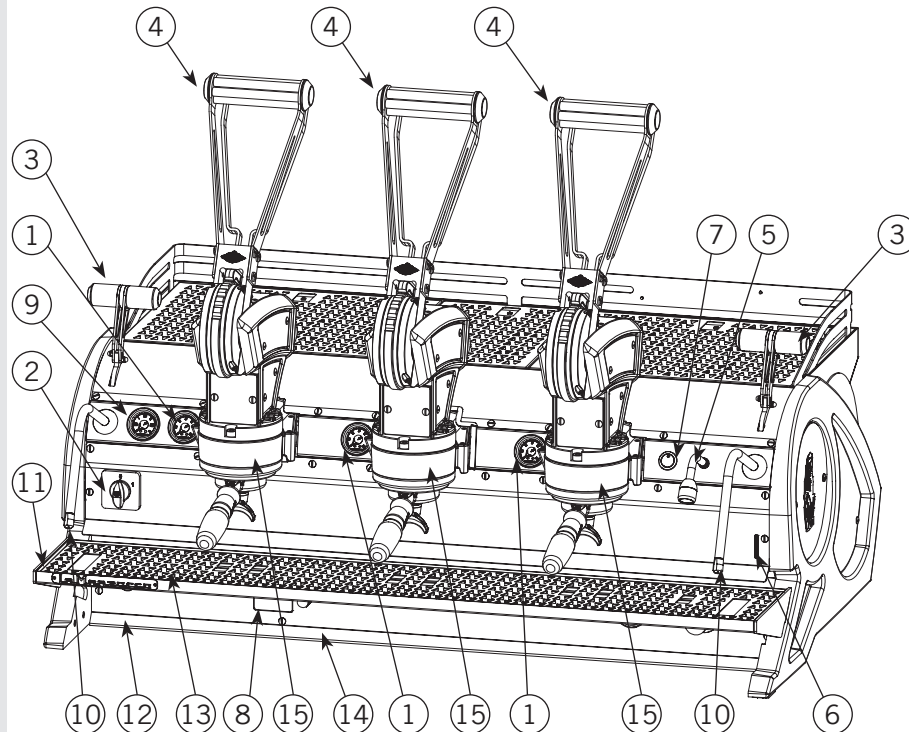

Fig. 1a - Model LEVA S - 2 or 3 groups

Legend

- | | |
|-----------|--------------------------------|
| 1 | Pressure Gauge (coffee boiler) |
| 2 | Main Switch |
| 3 | Steam Wand Lever |
| 4 | Delivery Lever |
| 5 | Hot Water Wand |
| 6 | Hot Water Mix Valve |
| 7 | Tea Water Button |
| 8 | Programming Display |
| 9 | Pressure Gauge (steam boiler) |
| 10 | Steam Wand |
| 11 | Removable Drain Tray |
| 12 | Waste Water Hose Holder |
| 13 | Drain Tray Grate |
| 14 | USB Key Connection |
| 15 | Delivery Group |

For additional information on electronics, keypads, and software programming, please see the section entitled Software Programming your Espresso Machine.

This operating manual refers exclusively to the following models, of our own manufacture:
LEVA X, model 3 groups

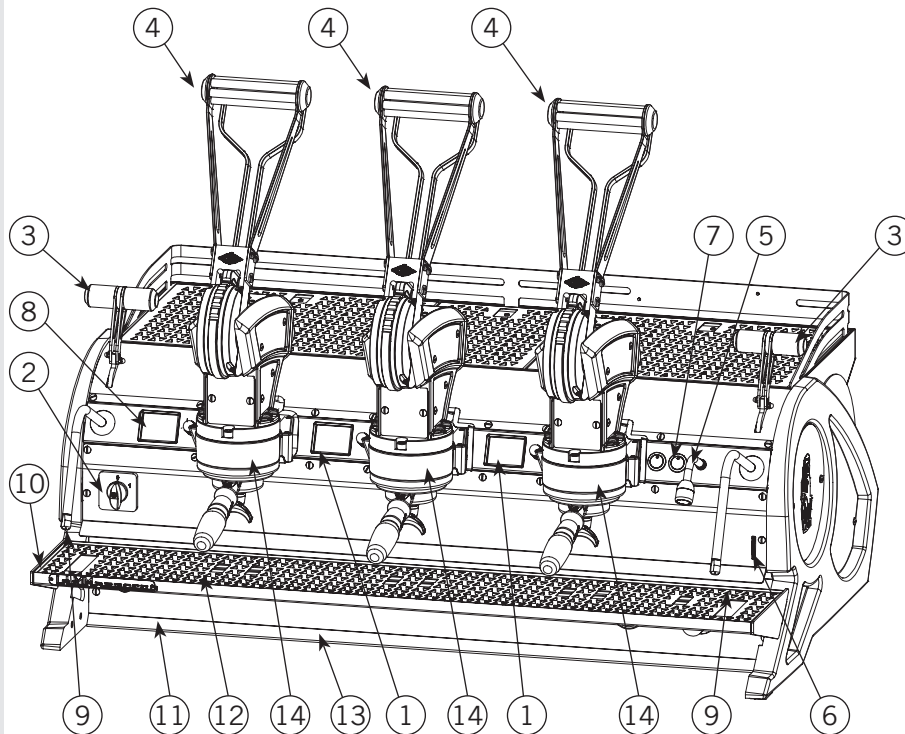

Legend

- 1 Display groupo
- 2 Main Switch
- 3 Steam Wand Lever
- 4 Delivery Lever
- 5 Hot Water Wand
- 6 Hot Water Mix Valve
- 7 Tea Water Button
- 8 Programming Display
- 9 Steam Wand
- 10 Removable Drain Tray
- 11 Waste Water Hose Holder
- 12 Drain Tray Grate
- 13 USB Key Connection
- 14 Brewing Group

For additional information on electronics, keypads, and software programming, please see the section entitled Software Programming your Espresso Machine.

Fig. 1b - Model LEVA X - 2 or 3 groups

This operating manual refers exclusively to the following models, of our own manufacture:
LEVA S and LEVA X

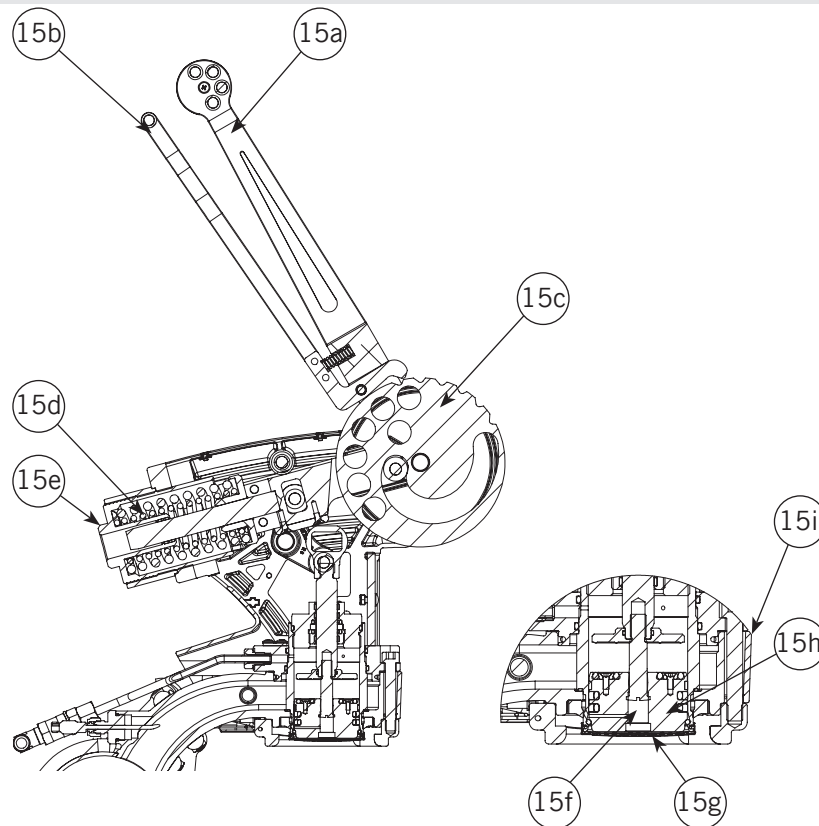

Legend

15a	Main lever
15b	Secondary lever
15c	Cam
15d	Spring system
15e	Adjustment ring
15f	Piston pin
15g	Diffuser screen
15h	Piston
15i	Coffee Boiler

WARNING: Never release the lever if the coffee panel isn't exerting an appropriate back pressure on the piston. In particular, never release the lever in any of the following cases:

- Portafilter not properly installed on the group.
- Portafilter installed but containing no coffee.
- No water in the machine.

Failing to comply with this provision may result in structural damages to the machine.

Fig. 2 - Models LEVA S and LEVA X - brewing groups

1) General Description

The machine is built in 2 and 3 coffee group versions and is essentially composed of the following parts:

- Steam Boiler (produces steam and hot water);
- Coffee (“saturated”) boiler;
- Brewing groups;
- Exterior Cover;
- Water pump (if present).

2) Description of the various parts

• Steam Boiler

The Steam Boiler consists of a cylindrical tank, of varying length according to the number of coffee groups, which is made of AISI 300 series stainless steel. Each unit is subjected to a hydraulic test, at a pressure of 6 bar, and has an operating pressure of 1.3-1.5 bar. The following is a list of effective volumes and power ratings according to the number of groups installed:

2 groups	8,2 liters	3000 Watts
3 groups	11,8 liters	4000 Watts

Covers are welded at either end of the cylindrical tank and on one of them there is a housing for the water heating element, which allows the steam boiler to reach operating pressure within approximately 25

minutes. Operating pressure is maintained by temperature probe and PID controller. The steam boiler has various fittings used for safety devices, for supplying hot water and steam, and for the heating element.

It consists of AISI 300 stainless steel tubes. Heating is accomplished through an immersion-type plated heating element.

- Operating pressure of 1.3-1.5 bar, controlled automatically through a pressure switch or a temperature probe, adjusted to open the heating element supply circuit at 1.5 bar and close it at 1.3 bar.

- The pressure is displayed by means of a pressure gauge with a scale of 0 to 2 bar.

- Safety device, based on an expansion type mechanical valve, with counter-acting spring adjusted to 1.8 bar.

- Testing: hydraulic test at 4.5 bar performed on ready-to-use small boilers, at our factory.

• Coffee Boiler

The Coffee Boiler consists of a cylindrical tank made of AISI 300 series stainless steel. One each group (hot water generator for brewing coffee).

Each unit is subject to a hydraulic test, at a pressure of 18 bar, and thus is suitable to operate with pressures of up to 6 bar,

the calibration value of the expansion valve. The following is a list of effective volume and power ratings according to the number of groups installed:

LEVA X:

2 groups	2 x 1,3 liters	2 x 800 Watt
3 groups	3 x 1,3 liters	3 x 800 Watt

LEVA S:

2 groups	1 x 3,4 liters	1 x 1400 Watt
3 groups	1 x 5,0 liters	1 x 1900 Watt

Covers are installed at either end of the cylindrical tank and on one of them there is housing for the water heating elements. A further electrical resistances, in addition, are installed at the top of the group and the bayonet ring. The coffee boiler temperature is kept constant by an electronic PID temperature control unit, with a precision of 0.2°C. The brewing groups are installed on the boiler.

It consists of AISI 300 stainless steel tubes. Heating is accomplished through an immersion-type plated heating element.

- Operating temperature 95°C (adjustable), controlled automatically by an electronic temperature controller with an accuracy of 0,2°C. Pressure inside the boiler depends on the setting of the pressure reducer - see page 27. In any case, its value is limited

by a special expansion valve, hereinafter referred to as “safety device”.

- Pressure is displayed through a pressure gauge with a scale from 0 to 24 bar.
- Safety device, based on an expansion type mechanical valve, with counteracting spring adjusted to 6 bar.
- Testing: Hydraulic test at 18 bar performed on ready-to-use small boilers, at our factory.

• Brewing groups

They consist of a precision casting made of stainless steel. The brewing group accepts the portafilter used to hold the ground coffee; the espresso flows through the brewing group, through the portafilter basket, through the portafilter spout, and into the cup(s) after the brewing button has been pressed.

• Exterior cover

The exterior consists of painted and stainless sheet steel panels. To provide good aesthetics, to optimize ergonomics for the operator and to reduce the chance of damage to a minimum.

• Water pump (if present)

The rotary vane pump, is installed on the water supply tubing and is set up to operate anytime the coffee groups are activated, and through an autofill system whenever the water boiler needs to be replenished. Set the bypass adjustment screw to a 4-bar pressure.

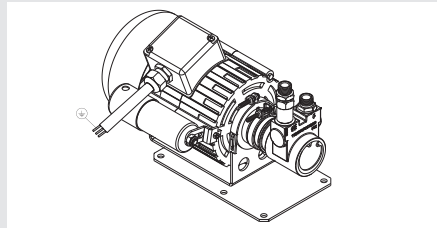

• Machine CE plate:

la marzocco		handmade in firenze		CE	
SERIE	LEVA X	MODEL	3GR	S/N	LV000000
V	220/230	W	7793	A	33.8
STEAM BOILER OP	0.15 MPa	MAX PUMP P		Hz	50/60
COFFEE BOILER LITERS	1.3x3	STEAM BOILER LITERS			0.9 MPa
MAX WATER INLET P	0.8 MPa				11.8
ESPRESSO MACHINE		www.lamarzocco.com		MADE IN ITALY	
Via La Torre, 14H • 50038 Scarpavia e San Piero (Firenze)					



• Machine ETL plate:

la marzocco		handmade in firenze		ETL	
MODEL	LEVA X 3GR	SERIAL No.	LV000000		
DATE	11/16	AMPS	30.8 / 33.8		
VOLTS	208/220-240	Hz	60	SINGLE PHASE	
MAX. OPERATING PRESSURE: STEAM	22 PSI	WATER	161 PSI		
ESPRESSO MACHINE		www.lamarzocco.com		MADE IN ITALY	

3. Installation

MODEL/SERIES	GROUP	V/Hz	RATED POWER (W)	RATED INPUT (A)	COFFEE BOILER WATTAGE	STEAM BOILER WATTAGE	TOTAL WATTAGE	POWER CORD SIZE (mm ²)
LEVA X	2GR	AC220-240V/60Hz	5664	24,7	2664	3000	5664	SEE ELECTRICAL CONNECTIONS FOR DETAILS
		AC208-240/60Hz		24				
	AC380-415/50Hz	15						
	AC220-240V/60Hz	33,8	3793	4000	7793			
	3GR	AC208-240/60Hz		33				
		AC380-415/50Hz		20,5				

POWER CORD:	
3 X WIRES 220V 1 X BLUE (NEUTRAL) 1 X BROWN (PHASE) 1 X YELLOW & GREEN (GROUND)	5 X WIRES 380V 1 X BROWN (PHASE) 1 X GRAY (PHASE) 1 X BLACK (PHASE) 1 X BLUE (NEUTRAL) 1 X YELLOW & GREEN (GROUND)

WARNING

THE DETAILS ON THE LEFT DESCRIBE HOW TO CONNECT EACH WIRE TO THE PLUG. RESPECT ALSO THE LOCAL SAFETY REGULATIONS.

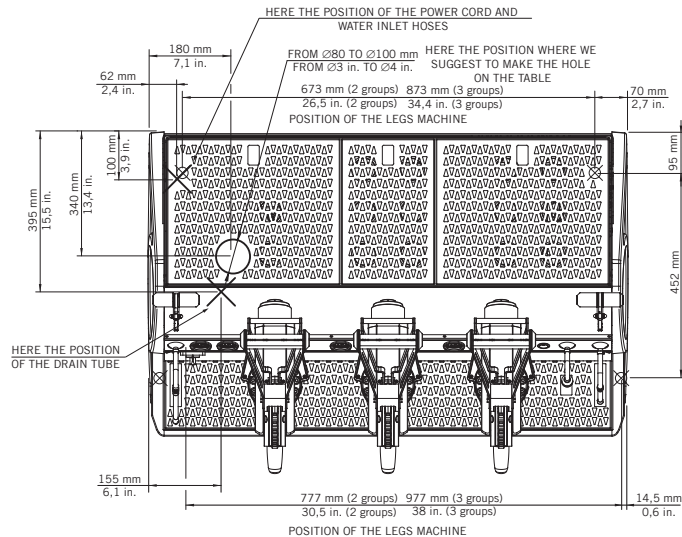

Fig. 3 - Installation guide

WARNING

The machine is intended to be permanently connected to fixed wiring, and it is mandatory that a residual current device (RCD) with a rated residual operating current not exceeding 30mA is installed.

WARNING

The Coffee Boiler and Steam Boiler contain water at elevated temperature. Water temperature over 125°F / 52°C can cause severe burns instantly or death from scalding (Coffee Boiler 207°F/97°C - Steam Boiler 256°F / 124°C)

WARNING

Replace fuses with the same size, type and rating F1 = 2A, 250V

WARNING

This machine should not be installed in kitchens.

▲ WARNING ▲
At each installation, the machine should be equipped with a new set of tubes for plumbing and related gaskets.

▲ WARNING ▲
Disconnect from power supply before the connection with the water pump.

▲ WARNING ▲
Water pressure supply must be between 2 and 4 bar if sufficient pressure is not available we suggest that an additional water supply system is used.

▲ WARNING ▲
Before making any electrical connections make sure that the two strain relief connectors are firmly secured to the body of the machine in order to prevent inadvertent stress on the power cables.

▲ WARNING ▲
Hazardous voltage disconnect from power supply before servicing.

▲ WARNING ▲
The motor pump must be situated close to the machine in an accessible place for maintenance but not for accidental interference and where there is an optimal air circulation.

▲ WARNING ▲
The manufacturer declines any responsibility for any event leading to liability suits whenever grounding has not been completed according to current local, national, and international regulations and electrical codes, or other electrical parts have been connected improperly.

▲ WARNING ▲
This appliance is not intended for use by persons (including children) with reduced physical, sensory or mental capabilities, or with lack of experience and knowledge, unless they have been given supervision or instruction concerning the use of the appliance by a person responsible for their safety.

▲ WARNING ▲
- U.S.A. and CANADA only - Do not connect to a circuit operating at more than 150V to ground on each leg.

▲ WARNING ▲
This machine is not suitable for outdoor use. Jets of water should not be used to clean the machine, nor should it be placed where water jets are used.



WARNING



In order to prevent cracks or leakage: do not store or install the Coffee machine in places where in boiler or hydraulicsystem to freeze.



WARNING



It is compulsory to install a 40A surge protector for 3GR version X and a 32A surge protector for 3GR version S and 2GR version S and X.



WARNING



For the connection of the machine, it must be provided a suitable disconnection device near the installation, so that in case of trip, it is possible to operate the device near the machine.

Note:

- The drinking water mains valve and the circuit breakers for the electrical system need to be located in the most convenient position for the operator to access them easily and quickly.
- The machine should be placed on a flat counter and must be placed in settings with the following temperatures:
Minimum room temperature: 5°C/41°F;
Maximum room temperature: 32°C/89°F.
- If the machine has been temporarily housed in settings with a room temperature of less 0°C/32°F, the machine must be placed in a warmer environment in order to gradually defrost the hydraulic system prior to use.
- Water pressure supply must be between 2 and 4 bar.
- This machine complies with the standard 61000-3-11, the impedance at the supply interface must be $Z_{max} = 0.17 \Omega$.

List of safety fuses inside the machine:

CE legend

- a** Pump 3.15A fuse
- b** Secondary transformer 1.25A fuse
- c** Primary transformer 1.25A fuse
- d** Pump 2A fuse (L1 phase)
- e** Pump 2A fuse (N1 neutral)
- f** Filling solenoid valve 2A fuse
- g** Hot water solenoid valve 2A fuse

ETL legend

- a** Pump 3.15A fuse
- b** Secondary transformer 1.25A fuse
- c** Primary transformer 1.25A fuse
- d** Pump 2A fuse (L1 phase)
- e** Pump 2A fuse (L2 phase)
- f** Hot water solenoid valve 2A fuse
- g** Filling solenoid valve 2A fuse

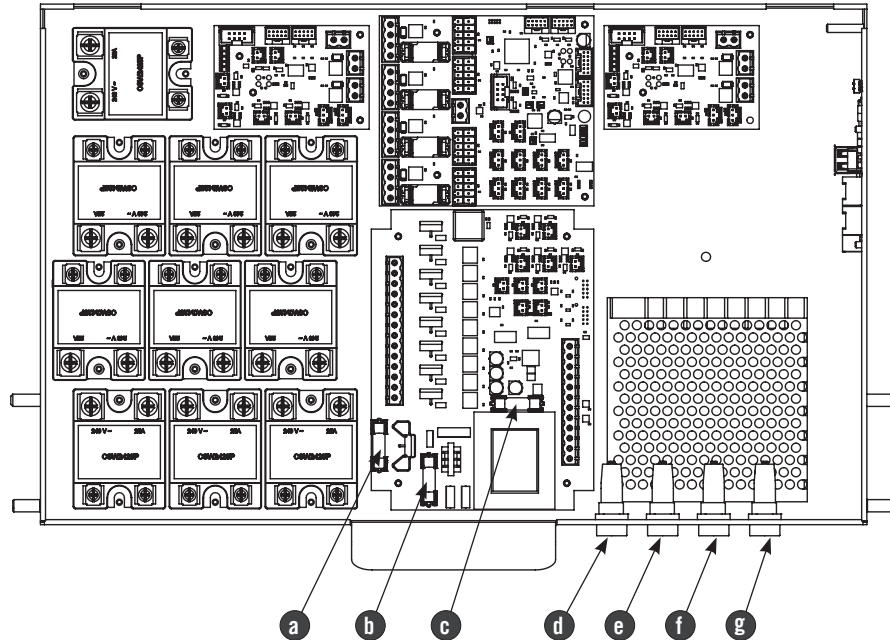

1) Installation guide

For best results, the machine needs an input water flow rate of at least 150 l/h, a minimum pressure exceeding the pre-infusion pressure and anyway no lower than 2 bar, and a temperature not exceeding 45°C (113°F).

Installations that do not meet these requirements will cause a shorter life of the pump and may cause a high noise level during coffee brewing.

If the incoming water of the espresso machine falls outside the recommended parameters, it is necessary to carry out one of the following installations:

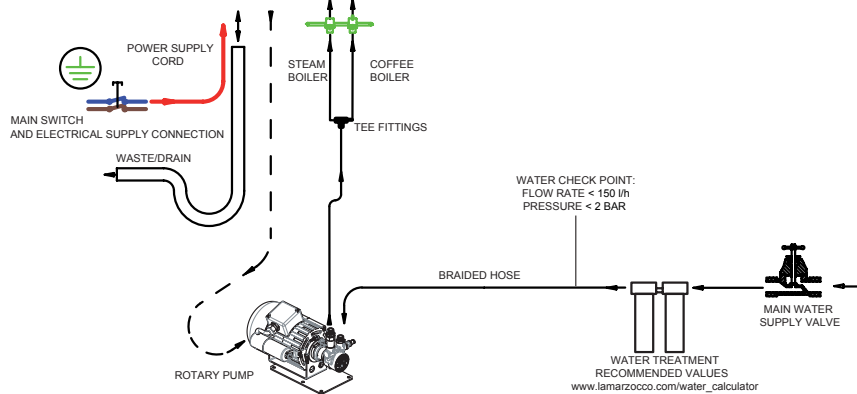
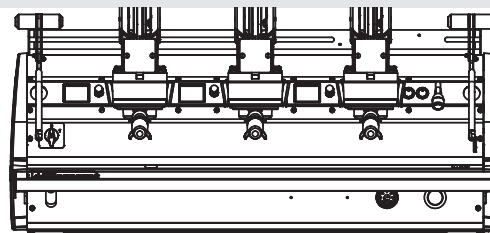

Pressure lower than 2 bar

Flow rate at least equal to 150 l/h and anyway no lower than the installed pump rate

Installation with the rotary pump (set to 4 bar) immediately after the water treatment system, upstream of the tee.

Fig. 4 - Installation guide - type 1

Pressure ranging between 2 bar and 4 bar
Flow rate higher than 150 l/h

Installation without rotary pump.

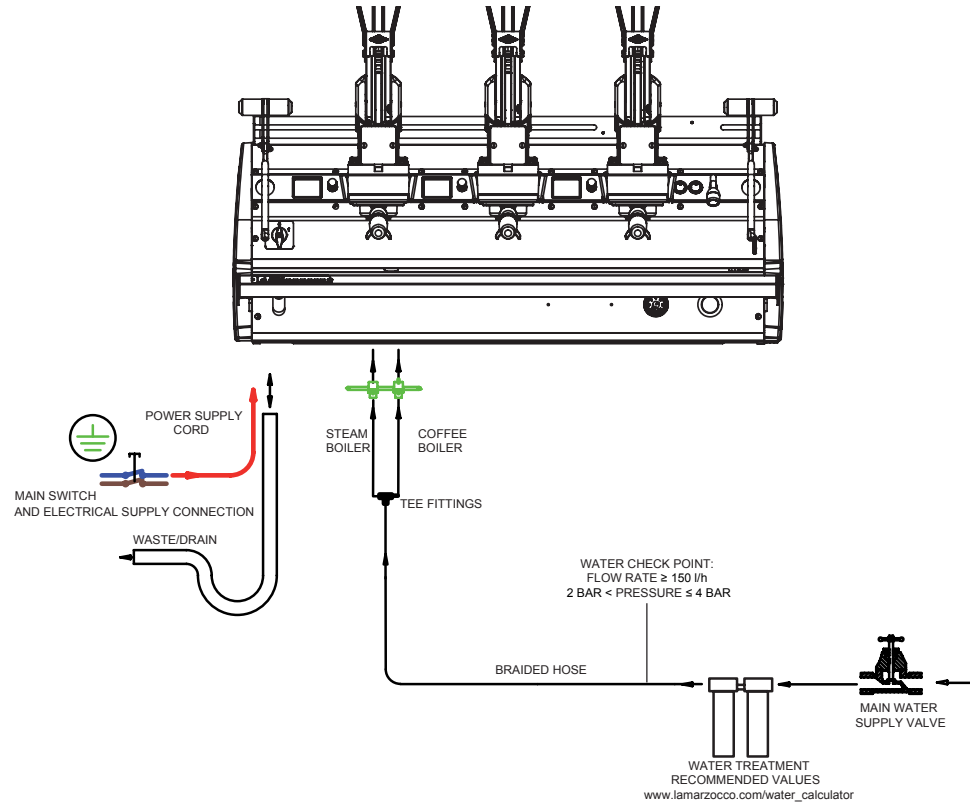

Fig. 5 - Installation guide - type 2

Pressure higher than 4 bar
Flow rate higher than 150 l/h

Installation of the pressure reducer
immediately downstream of the
water treatment system.

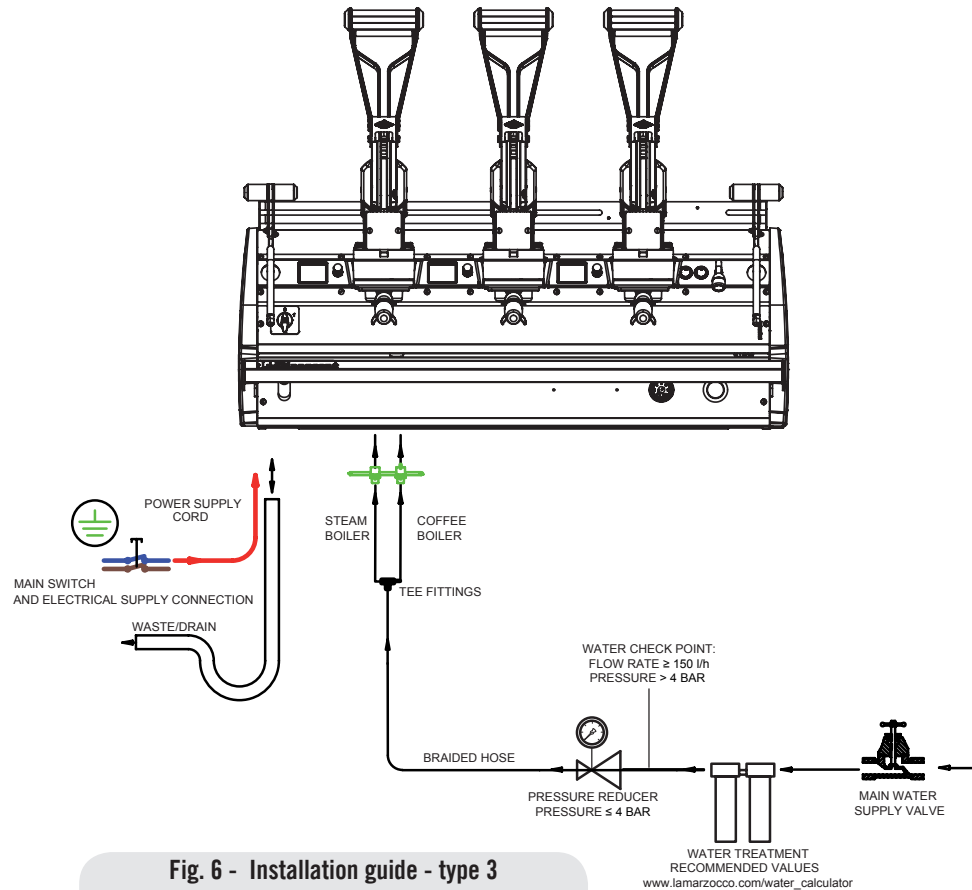

Fig. 6 - Installation guide - type 3

2) Accessories

Check the package to make sure that the following accessories are included:

- a number of 1-dose and 2-dose portafilters corresponding to the number of groups;
- replacement 1-dose and 2-dose filters (one of each);
- 1 tamper;
- 1 blind filter;
- cleaning detergent, for the groups;
- 3 stainless steel braided hoses for water connections;
- 1,5 mt of reinforced plastic tubing for drainage;
- 1 hose clamp;
- 1 TEE Fitting.

In order to proceed with installation, it is necessary that the following are available:

- Pipes carrying drinking water with a 3/8" G (BSP) end connection; (3/8" Compression for USA and Canada)
- Electrical Supply according to the specification of the espresso machine purchased:
- Single/Three phase 220VAC - 50/60 Hz electrical connection with ground, protected socket and approved interlock switch
- Single phase 200VAC - 50/60 Hz electrical connection with ground, protected socket and approved interlock

switch

- Three-phase, 380VAC - 50 Hz electrical connection with neutral + ground, near the bench on which the machine is installed and terminating in a suitable protected fivepole socket equipped with an approved interlock switch
- Waste water drain system.

3) Water test kit

In order to enable you to check if your water supply is within the suggested ranges, La Marzocco machines will be equipped with two units of a quick water test kit (see image below) including 6 test-strips and instruction cards.

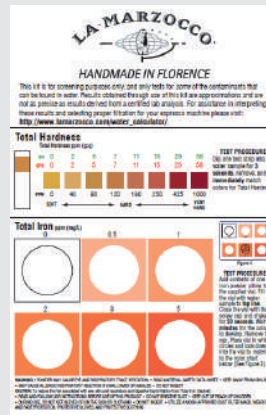

The parameters that you can measure are Total Hardness, Total Iron, Free Chlorine,

Total Chlorine, pH & Total Alkalinity, Chlorides.

Ideally, you should perform a test on the water BEFORE the water treatment system and again AFTER the water system in order to verify if this is actually matching our suggested ranges.

Once the test has been performed, learn which treatment system is most appropriate for your particular water supply by filling out the online water calculator on our website: LA MARZOCCO WATER CALCULATOR (http://www.lamarzocco.com/water_calculator/).

4) Water supply connection

In order to connect the machine up to the water mains proceed according to the indications given in the chapter about Installation and in compliance with any local/national safety standards of the location in which the machine is being installed.

The equipment is to be installed with adequate backflow protection to comply with applicable federal, state, and local codes.

To guarantee a correct and safe functioning of the machine and to maintain an adequate performance level and a high quality of the beverages being brewed it is important that the incoming water be of a hardness greater than 7°f (70ppm, 4°d) and less than 10°f (100ppm, 6°d),

pH should be between 6.5 and 8.5 and the quantity of chlorides be less than 50mg/l . Respecting these values allows the machine to operate at maximum efficiency. If these parameters are not present, a specific filtration device should be installed, while always adhering to the local national standards in place regarding potable water.

Then connect the inlet of the water filter/softener (if present) to the drinking water supply using one of the supplied stainless steel braided hoses. Before connecting the filter to the water pump, flush the water supply line and the filtration system in order to eliminate any residual particles which could otherwise get stuck in taps or valves thus preventing them from working properly. Connect the water supply connection of the espresso machine to the water pump outlet using one of the supplied stainless steel braided hoses. Then connect the water pump inlet to the water filter/softener outlet (if present).

Note: The water pump is a differential pressure volumetric pump and has been designed to be used exclusively with cold water. Make sure that water is always present while the pump is operating, otherwise air can be introduced into the brew boiler causing an undesirable condition and the pump can be damaged.

5) Electrical connections

a) Power supply cord

- This is the main power supply cable that provides power to the entire espresso machine. There are different types of cable based upon the electrical requirements of the espresso machine purchased:
- 200/220VAC 1 Phase 3-core cable with 4/6/10mm² cross section or AWG 12/10/8 for 2,3 4 group versions, secured to espresso machine via a strain relief connector
- 220VAC 3 Phase 4-core cable with 4 mm² cross section for 2 , 3 and 4 group versions, secured to espresso machine via a strain relief connector
- 380 VAC 3 Phase 5-core cable with 2.5mm² cross section for 2, 3 and 4 group versions, secured to espresso machine via a strain relief connector.

b) Water pump motor power cord

This is the power supply for the water pump motor. The internal electronics will switch the pump motor on when needed.

- 3-core cable with 1.5 mm² cross section or 3-core AWG 16 (for UL version) secured to espresso machine via a strain relief connector.

c) Quick connection between the water pump and the espresso coffee machine

The electrical connection must be made

through the use of the connectors, as shown in the following figures:

- View of the connectors;

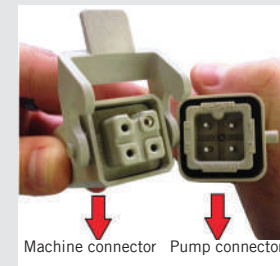

- Cable connection;

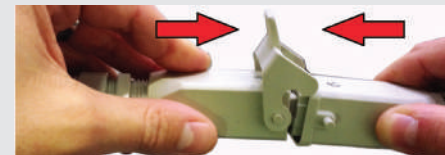

- Cable tightening;

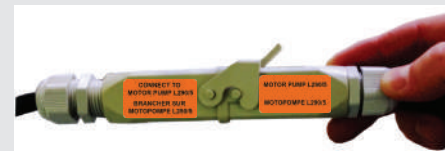

6) Waste water drain connection

The espresso machine drain is to be connected by means of the included reinforced plastic tubing. Connect one end of the reinforced plastic tubing to the drain hose connection on the left side of the espresso machine, secure with included hose clamp. Connect the other end to a suitable waste water collection system.

In case such a system is not available, drained liquids may be collected in a suitable bucket and any necessary drain pipe extensions shall be made using steel-lined PVC tubing and suitable hose clamps.

Water specifications table

		Min.	Max.
T.D.S.	ppm	90	150
Total Hardness	ppm	70	100
Total Iron (Fe ⁺² /Fe ⁺³)	ppm	0	0,02
Free Chlorine (Cl ₂)	ppm	0	0,05
Total Chlorine (Cl ₂)	ppm	0	0,1
pH	value	6,5	8,5
Alkalinity	ppm	40	80
Chloride (Cl ⁻)	ppm	not more	50

N.B.: Test water quality (the warranty is void if water parameters are not within the range specified in the section “installation”)

4. Machine Operation and Coffee Preparation

CAUTION

Never remove the filter holder when water is being delivered. This operation can be extremely dangerous since the high pressure built-up inside the blind filter would spray out hot and slightly caustic water, which may cause severe burns. The Coffee Boiler contains water at elevated temperature. Water temperature over 125°F / 52°C can cause severe burns instantly or death from scalding.

WARNING

This machine is designed only for preparing coffee and hot drinks.

WARNING

The machine must not be dipped in, nor splashed with, water in order to clean it. For cleaning operations, please follow the instructions listed below very carefully.

WARNING

Never remove the portafilter if:

- delivery is not over
- the pressure read on the relevant pressure gauge is higher than the pre-infusion value
- the pressure read on the analogue or digital pressure gauge exceeds zero.

To remove the portafilter in one of the previous cases follow the indications contained in paragraph "Removing the portafilter when it is under pressure".

IMPORTANT

To improve the flavor of the espresso, the temperature of the water in the coffee boiler and therefore of the groups may eventually be raised or lowered via the digital display (please consult the Software Programming Manual for detailed instructions).

1) Removing the portafilter when it is under pressure

You might have to remove the portafilter while it is subject to the pressure exerted by water.

This happens in the following two cases:

- The portafilter has been erroneously filled with an excessive dose of coffee powder, obstructing the water/coffee flow.
- A flushing with a blind portafilter is under way.

In these cases you need to operate the control lever to lift the piston by a few millimetres, to counteract the pressure exerted by the spring. Pressure will drop to the pre-infusion value.

WARNING: pressure will not drop to zero.

Now you can slowly remove the portafilter, driving the piston downward by means of the lever.

WARNING: hot water will inevitably flow out, so:

- Protect your body with appropriate clothing and/or keep well away,
- Wear gloves providing protection against heat,
- Keep exposed body parts, like your face, well away.

2) Starting the espresso machine

a) Filling the boilers with water

Once the installation procedures have been completed, it is necessary to fill the boiler tanks with water. Complete the following procedure to properly fill the boiler tanks:

• Coffee boiler

The water flows inside the coffee boiler directly, as soon as the water system and purifier taps (if present) are opened. Since the inflow of water will compress the air in the boiler, it will be necessary to remove or “bleed” the air from the coffee boilers. All air must be removed in order to completely “saturate” the coffee boiler/group assemblies.

To remove the air from the boiler, or “bleed the groups”, it will be necessary to remove the plastic keypad from the top of the group.

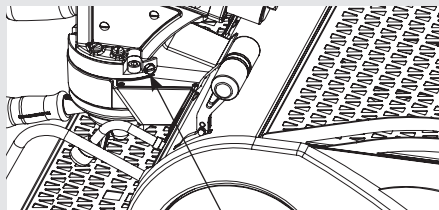

Purge screw

Loosen the bleed screws one at a time to allow air to escape until water flows from below the screw head. Tighten the screw to stop the water from flowing. Over tightening can cause damage to the sealing washer and the group cover. Repeat this procedure on all groups.

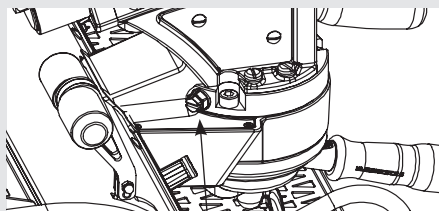

Purge screw

WARNING: hot water or pressurised steam will inevitably flow out, so:

- Protect your body with appropriate clothing and/or keep well away,
- Wear gloves providing protection against heat,
- Keep exposed body parts, like your face, well away.

• Steam boiler

Turn the main switch to position “1” or ON, the automatic steam boiler level gauge will be switched on, activating the auto-fill solenoid valve and the motor pump. This will fill the steam boiler to a predetermined level and will shut off when full.

Note: Air existing in the boiler may generate a certain pressure (which can be read on the pressure gauge scale).

Once the pump stops, check the display. The message “Coffee boiler filled?” should be displayed. Press the encoder knob to confirm that the previous procedures have been completed.

The installation is now complete and the espresso machine should be heating to operating temperatures.

3) Waiting for the Espresso Machine to Heat to Operating Temperature

Display

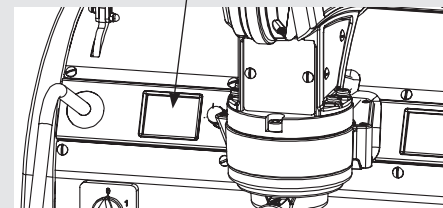

During this time, it may happen that the pointer of the coffee boiler pressure

reaches as high as 14-15 bar. This may happen anytime that the heating element is in the “on” condition. In this case, it is necessary to adjust the expansion valve (see the picture below about the three coffee boiler expansion valves) in such a way that the pressure never exceeds 6 bar.

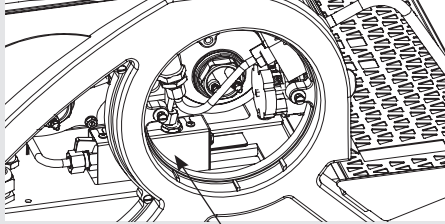

Expansion Valve

The steam boiler pressure can be read through a pressure gauge located inside the machine, behind the control and the 1st group.

When the steam boiler reaches operating temperature, the light on the Tea dispense button will switch on.

4) Brewing after first installation

Once the first installation procedures are finished, before proceeding with brewing coffee, hot water and steam, please follow these steps:

- Engage the portafilters by inserting them into each group, brew water through each group for at least two minutes.
- Being careful to avoid burns, turn on

each steam wand for at least one minute.

- Turn on the hot water valve for the time necessary to allow the following quantities of water to be brewed:
 - At least 1 liter for a 1/2 group machine
 - At least 2 liters for a 3 group machine

5) Installing the portafilters

Install the portafilter(s) by inserting them into the group and rotate the handle from left to right. After properly inserting the portafilter you can operate the lever, lowering it by a few degrees to let water flow out of the portafilter. You should allow hot water to pass through the empty portafilter(s) for a few seconds each time, in order to preheat the portafilter.

Note: It is important to leave the portafilters installed in the espresso machine when not in use. The portafilter must remain heated for the brew process to function correctly.

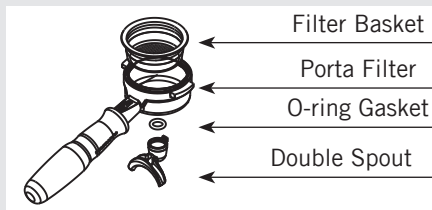

6) Brewing coffee

Now you can brew an espresso. Disengage one of the portafilters, fill the filter with ground coffee, tamp the ground coffee with the tamper supplied (exerting a force of 20 kg) and re-engage the portafilter to the group. Operate the lever and raise the piston by the desired amount to load the water. Wait for a few seconds until the pressure read by the analogue or digital pressure gauge reaches the pre-infusion value. From now on you can release the lever to start the delivery process. Before releasing the lever slightly move it upward, then keep raising it until reaching the vertical rest position.

Note: Some baristas believe it is important to press the brewing button prior to installing the portafilter to allow the water to flush any remaining coffee oils and particles from the group. Some also flush just after brewing coffee for the same reason. Please experiment to find the best possible procedure for you.

7) Water pump

Whenever you are brewing coffee, and you can adjust the pump pressure by turning the by-pass screw (below the plug located on the side to which the pump power supply is connected) clockwise to increase and counter-clockwise to reduce pressure. Set pressure to a value slightly higher than

the pre-infusion pressure.

We recommend that you do not exceed 4 bar.

WARNING: never set the pump pressure to a value exceeding 9 bar. Pressure higher than 9 bar may irreparably damage the pressure reducer.

Note: When the heating element in the coffee boiler is energized, the water will expand increasing the start-up pressure. Once the maximum pressure is reached, the expansion (safety) valve should start working by discharging a few drops of water, in order to prevent such pressure from exceeding 5-6 bar.

In case the pressure exceeds 6 bar, you must adjust the expansion valve by unscrewing the cap slightly. If this is not sufficient, remove the valve and clear away any calcium deposits. This remedy is valid also in case the valve remains open in the drain position (i.e. the pressure cannot increase to 8 bar approx.).

8) General notes for coffee preparation

The portafilters must remain heated since they are at the lowest position of the group itself, and they are partially isolated due to the rubber gasket between them. This can be accomplished by leaving the portafilters installed in the machine when not in use. The portafilters may also be

actively heated. This procedure may be carried out by brewing some hot water through the portafilter then turning off the water flow, before making coffee.

It is important to remember that coffee left over in the filters must be removed only when you need to prepare another cup, and only at that time should you place a new dose of ground coffee in the filter.

The size of the coffee granules is extremely important in preparing a good cup of coffee, other than the type of coffee mix used, quite obviously. The ideal grinding can be determined by making various coffees using the amount of ground coffee that you would normally use for each cup (we recommend at least 6-7g). The best grinding is that which allows coffee to flow out from the filter holder spouts neither too slowly (drop by drop) nor too quickly (quick light brown flow). A general rule is that a double dose should dispense approximately 25cc or 2 fluid oz. of espresso in approximately 25 seconds.

9) Cup Warmer

Press Cup Warmer Button for enabled or disabled the cup warmer. This function work in two modes continuous or timed (see the Software Programming Manual for further instructions).

Cup Warmer Button

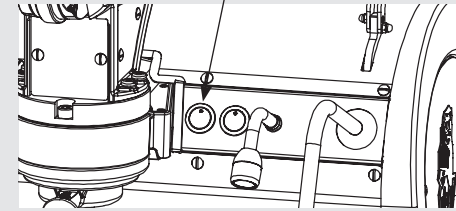

10) Coffee delivery control levers

10.1) General description

The control lever consists of two levers, called “main lever” and “secondary level”. When at rest, both levers are disconnected from the piston and from the spring; in other words, simply turning the levers causes no action to be performed on the group.

In order to perform a flushing or a delivery, you first need to move the levers until they are in contact each other, to establish a mechanical connection between the lever assembly and the group.

Now you can lower the lever, causing the piston to raise and the spring to be compressed.

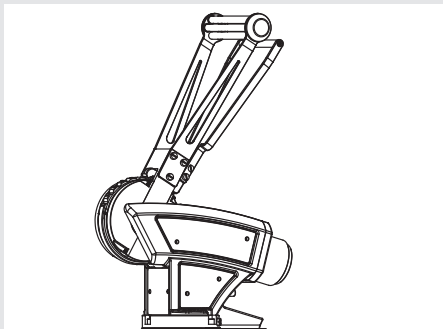

You just need to lower the lever by a few degrees for water loading and then pre-infusion to start.

The longer the lever stroke, the more water is loaded and the higher the resulting delivery pressure. If you move the lever by a full half-turn (180°), the following will occur:

- The delivery pressure reaches its maximum value.
- The maximum dose is delivered.

10.2) Releasing the lever

Before releasing the lever gently move it upward until you feel the resistance exerted by the system. Then disconnect the main lever from the secondary one and if desired move them back to the rest position.

WARNING: When using the lever we recommend that you do not exceed 12 bar

as the delivery pressure value. Exceeding this value might result in damages to some machine parts, like filters.

In order to warn the operator that the recommended pressure has been exceeded, the corresponding areas are marked in red on the display of both analogue and digital pressure gauges.

WARNING: Never release the lever if the coffee panel isn't exerting an appropriate back pressure on the piston. In particular, never release the lever in any of the following cases:

- Portafilter not properly installed on the group.
- Portafilter installed but containing no coffee.
- No water in the machine.

Failing to comply with this provision may result in structural damages to the machine.

10.4) Dose adjustment

If you fully raise the piston, and then wait until the system has loaded all the water and the coffee panel has absorbed the relevant amount, the machine will be able to deliver the maximum dose.

Its value depends on many factors, including the coffee type, the amount of powder in the portafilter, the grinding grade and the force exerted when it was pressed.

Under normal conditions, however, the machine is designed to deliver a dose of about 50cc.

Raising the piston partially will result in the delivery of a proportionally smaller dose.

10.5) Force to be exerted on the lever

The force the barista has to exert on the lever in order to fully raise the piston depends on the spring preload. The higher the preload the greater the force the barista will have to exert.

In the following condition:

- pre-infusion pressure: 3bar
- spring set to generate a maximum pressure of: 12bar

the barista will have to exert on the lever a force of about 8kg.

WARNING: We recommend that you set the spring preload and the pre-infusion pressure in such a way as to ensure that the delivery pressure doesn't exceed 12 bar. Exceeding this value might result in damages to some machine parts, like filters.

10.6) Safety precaution

While raising the piston we recommend that you pay particular attention to the following:

- Do not accidentally release the lever.

- Make sure that the lever trajectory doesn't intercept any body parts (especially face parts).
- Make sure that no other operator is standing nearby.

10.7) Adjusting the pre-infusion pressure

Turning the regulator knob clockwise will increase the pressure.

Turning the regulator knob counterclockwise will decrease the pressure.

NOTE: the reducer is of "no relieving" type; that means the reducer cannot relieve the downstream circuit pressure. As a consequence, just turning the reducer counterclockwise will not result in a pressure decrease; you also need to relieve the excess pressure by opening a group.

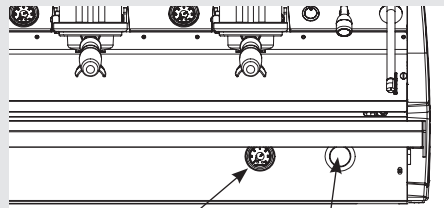

Pre-infusion pressure adjuster

Pre-infusion pressure adjuster

We recommend that you never set any pressures outside the 2÷4bar range.

10.8) Adjusting the spring preload

The spring system lies inside an adjustable housing (1). A screw control allows to increase or decrease the spring preload in order to increase or decrease pressure.

To adjust the preload:

- Unscrew the lock nut using your hands (2)
- Using a size-30 spanner, turn the housing (1). Turn it clockwise to increase the preload or counterclockwise to reduce it.
- Manually re-tighten the lock nut (2). This lock nut must be tightened by hand with strength and tightening must be checked from time to time.

The marks (3) may be used as an approximate indication of the pressure value. The difference between two consecutive marks corresponds to approximately 1bar.

To verify that the pressure has been accurately regulated, brew a coffee and read the pressure value on the group pressure gauge/display.

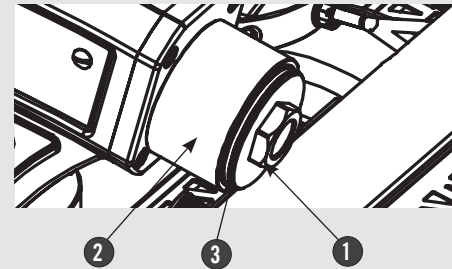

5. Dispensing Steam and Hot Water

1) Steaming milk or other liquids

In order to allow for any condensed water in the wand to be released ALWAYS allow some steam to be discharged by turning on the valve before inserting the steam wand into the pitcher of liquid to be heated.

Dip one of the 2 steam wands (part 8, page 7) which are connected to the steam valve, into the liquid to be heated, turn the steam knob gradually until steam comes out at the end of the wand.

The steam will transfer heat to the liquid raising its temperature up to boiling point. Be careful not to allow liquid to overflow in order to avoid severe burns.

In order to prevent the heated liquid from being sucked back into the steam boiler it is recommended before using the wand that you purge the steam valve and steam wand by opening the valve for a few seconds to allow steam to escape to the atmosphere from the end of the steam wand. Failure to do so can cause the heated liquid to transfer from the heated liquid container to the steam boiler

(via vacuum created from cooling parts). This condition is undesirable and can cause contamination in the steam boiler. After use remember to purge the wand by opening the steam valve for a few seconds, and then clean the outside of the wand itself with an appropriate cloth.

In order to prepare milk for making cappuccino with the right amount of foam, go through the following steps:

- After purging the steam wand place the container half-full of milk underneath, carefully open the steam valve and raise the container so as to bring the wand end to a point just below the surface of the milk; at this point, move the container up and down just enough to dip the nozzle end in and out of the milk until you get the right amount of foam, bring the temperature of the milk almost up to 149/158°F or 65/70°C. You can then pour this milk into a cup containing warm espresso and you will end up with a fresh cup of cappuccino.

2) Preparing tea and other hot drinks.

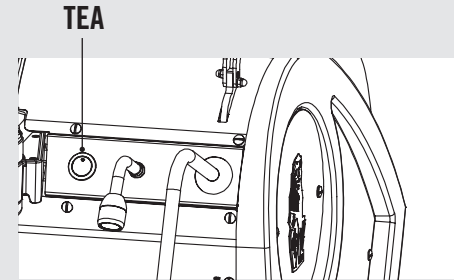

You may dispense hot water by using the fixed nozzle (part 6, page 7). To dispense hot water, press the tea water button.

This button commands hot water delivery. The temperature of the water may be adjusted by adjusting the mixing valve.

6. Maintenance and Periodic Cleaning Operations

WARNING
Jets of water should not be used to clean the machine, nor should it be placed where water jets are used.

WARNING
The machine must be installed so that qualified technical personnel can easily access it for eventual maintenance.

WARNING
Do not remove the filter holder while relative group is brewing hot liquids.
The Coffee Boiler contains water at elevated temperature. Water temperature over 125°F / 52°C can cause severe burns instantly or death from scalding.

WARNING
This machine is for professional use only and should be installed in locations where its use and maintenance is restricted to trained personnel.

WARNING
The machine must not be dipped in, nor splashed with, water in order to clean it. For cleaning operations, please follow the instructions listed below very carefully.

WARNING
If the above-mentioned instructions are not adhered to the manufacturer cannot be held responsible for damage to persons or things.

WARNING
The machine is intended to be permanently connected to fixed wiring, and it is advisable that a residual current device (RCD) with a rated residual operating current not exceeding 30mA is installed.

WARNING
In order to prevent cracks or leakage: do not store or install the coffee machine in places where temperature may cause water in boiler or hydraulic system to freeze.

1) Cleaning of groups and diffuser screens

- Remove the diffuser screen and wash it separately as described further below.
- Using a wet soft cloth, clean the surface of the piston laying under the removed diffuser screen.
- Unscrew the siphon screw.
- Add a spoonful of espresso-specific powder detergent to the blind filter in the portafilter (following the instructions provided by the product manufacturer), then insert the portafilter into the group you wish

to clean.

By operating the lever, raise and lower the piston multiple times until the water flowing out of the siphon is clear and contains no soap.

WARNING: during this stage, do not release the lever. The system cannot generate enough back pressure to prevent hammering, which may damage the machine.

2) Cleaning filters

- Put 2 or 3 teaspoons of detergent powder for coffee machines in about 1/2 a litre of water inside a heat-resistant container and boil.
- Dip filters in the boiled solution and leave them fully submerged for about 30 minutes.
- Rinse thoroughly with clean water and run hot water through one group several times with the filters in place.
- Make one cup of coffee and discard in order to remove any unpleasant flavor.

3) Cleaning filter holders (portafilters)

Using the proper cleaning tool (brush) wash the filter holders under hot water, a neutral detergent may also be used. For extraordinary cleaning see the Portafilter Manual.

4) Cleaning the drain collector

Remove the drain tray grill at least twice a week and clean, pull out the water drain collector and clean it thoroughly. Inspect and clean also the drain box and remove any leftover grounds.

5) Cleaning the body

Wipe the stainless steel surfaces with a soft, non abrasive cloth in the direction of the glazing marks, if any. Do not use any alcohol or solvents whatsoever on painted or imprinted parts in order not to damage them.

6) Cleaning the hot water and steam nozzles

Steam nozzles must be cleaned immediately after use with a damp cloth and by producing a short burst of steam so as to prevent the formation of deposits inside the nozzles themselves, which may alter the flavor of other drinks to be heated. Hot water nozzles must be cleaned periodically with a damp cloth.

7) Cleaning the diffuser screen

During normal usage, coffee residues may stain the diffuser screen and the bottom section of the piston. To clean them, you will have to remove the diffuser screen, if needed using a spoon handle to lever it out. Then clean the diffuser screen with the powder detergent; also clean the

bottom surface of the piston with a wet (non-abrasive) sponge.

Rinse with plenty of clean water before reinstalling the diffuser screen.

After reinstalling it and making sure that the spring has snapped, operate the group multiple times to rinse it.

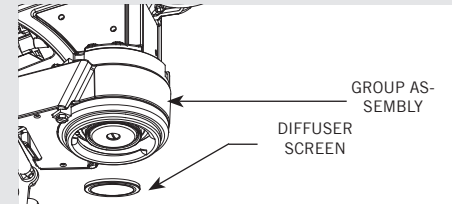

WARNING: if you perform the cleaning procedure while the machine is hot, the diffuser screen, the parts around it and the rinsing water will be hot. Protect yourself by wearing gloves.

8) Cleaning the pressure gauge/transducer siphon

Should you notice any operation fault in the delivery pressure gauge or in the transducer, it might be due to the duct being entirely or partially obstructed by coffee residues. In this case proceed as follows:

- Install a blind portafilter
- Unscrew the screw indicated by the arrow
- Operate the lever to carry out a flushing.
- Once the flushing is completed turn the screw back in.

Carry out a test by brewing a coffee.

WARNING: if cleaning is performed while the machine is hot, the water flowing out of the screw will be hot.

WARNING: if cleaning is performed while the machine is hot, the screw will be hot; wear gloves.

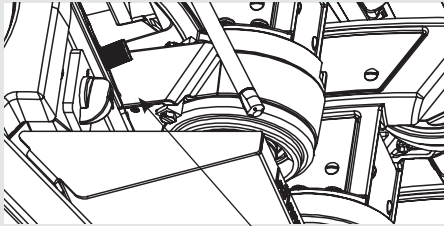

Siphon Screw

9) Water Filter/Softener

Please see the documentation accompanying the water filter/softener for proper operating and cleaning instructions.

10) Depressurize the steam boiler

Press and hold the encoder knob to set the espresso machine to “OFF”, then push down the steam lever in order to depressurize the steam boiler.

IMPORTANT

If the machine has not been used for more than 8 hours or, in any case, after long periods of being idle, in order to use the machine to its full potential it is necessary to perform some cleaning cycles before brewing beverages as follows:

- Groups: with the portafilters engaged in

the groups brew water through each for at least two minutes

- Being careful to avoid burns, turn on each steam wand for at least one minute.
- Turn on the hot water valve for the time necessary to allow the following quantities of water to be brewed:
At least 1 liter for a 1/2 group machine
At least 2 liters for a 3 group machine

If the machine is not going to be used for long periods of time, it is advisable to follow these safety indications:

- Disconnect the machine from the water mains or interrupt the water connection via a mains tap.
- Disconnect the machine from the electrical mains.

7. De-commissioning and Demolition

1) De-commissioning and demolition

Start by setting the main switch to the “0” or OFF position.

Disconnecting from the power outlet

Disconnect the espresso machine from the electrical network by switching off the associated circuit breaker or circuit protection device. Remove the power supply cord from the power connection. Remove the Pump Motor Power Cord from the water pump motor.

Disconnecting from the water system

Shut off the water supply by closing the specific tap located upstream of the water filter/softener inlet. Disconnect the water pipe at the water filter/softener inlet.

Remove the hose connecting the espresso machine to the water pump. Remove the reinforced plastic tubing on the drain connection.

At this point, the machine may be removed from the bar, being very careful not to drop it or squash your fingers.

The machine is made out of various materials and therefore, if you do not intend to put it back in service, it must be taken to a special disposal company which will select the materials which can be recycled and discard the others.

Current regulations make it illegal to discard such machine by leaving it on public grounds or on any private property.

Recycling notice: Warning for the protection of the environment:

Used Electrical and electronic waste contains hazardous but also valuable and scarce materials which should be recovered and recycled properly. We kindly ask that you contribute to the protection of the environment and natural resources by delivering used equipment to the relevant recycling locations if such locations are available in your country.



8. Mandatory Maintenance and Check-up Operations

These operations are in addition to the Maintenance and Periodic Cleaning Operations as specified in Chapter 6.

The following maintenance and check-up operations could be carried out by a qualified technician.

The time required for the periodic maintenance is determined by the quantity of daily work and/or coffee consumption.

N.B. These periodic maintenance operations are not covered by warranty.

EVERY THREE/FOUR MONTHS

- Replace group gaskets
- Replace diffuser screens
- Clean auto-fill probe
- Check vacuum breaker for proper operation
- Inspect water inlet valve
- Check brew temperature
- Checking the pre-infusion and delivery pressure
- Check all switches for proper operation
- Check/note water hardness (Water quality must be within the range of parameters specified in the chapter on Installation, saturation otherwise warranty is voided)
- Check filter basket condition
- Expansion valve inspection
- Spring stem inspection
- Cam inspection
- Check for cylinder complete

EVERY YEAR (in addition to the above)

- Replace portafilter baskets
- Inspect vacuum breaker
- Inspect electrical wiring condition
- Inspect boilers safety switches
- Replace over-pressure valve (safety valve)
- Accurate control of the tightness at 2,4Nm of each cable on the terminal block
- Replacement of piston seals
- Check for tightness of the lever

mechanism screws

Version S:

- Overhaul of steam taps

Version X and 90:

- Inspection of steam proportional valve

EVERY 2 YEARS (in addition to the above)

- Replacement of piston stem seals
- Replacement of spring stem guide rings
- Replacement of cam wheel
- Replacement of lever mechanism rollers

EVERY 3 YEARS (in addition to the above)

- Check the condition of the inside of boilers and if necessary rinse out with a proper cleaning product allowed for food and beverage appliances.

9. Software Programming Guide

“Barista” Programming

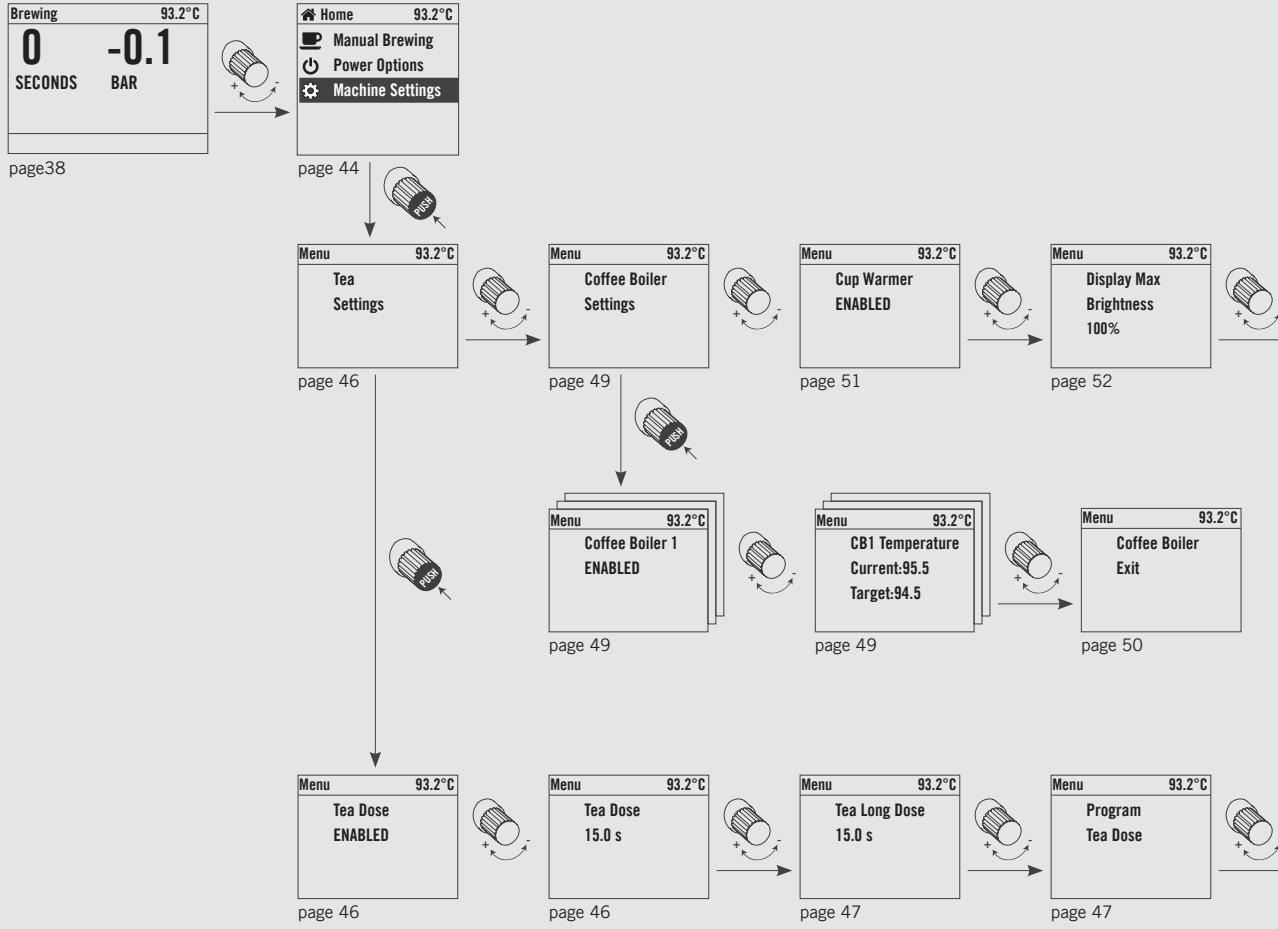

“Barista” Programming

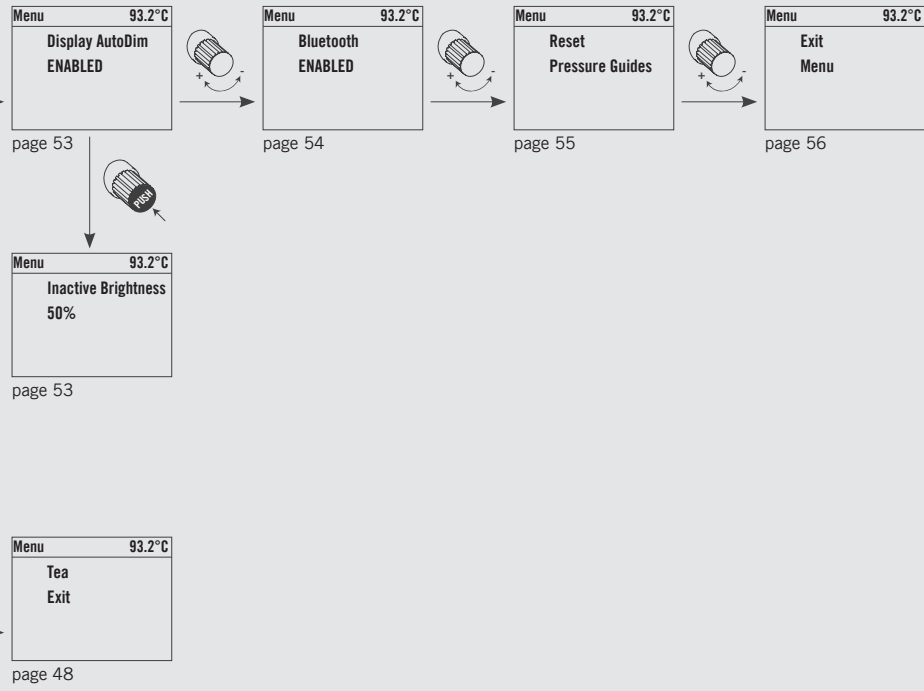

“Technical” Programming

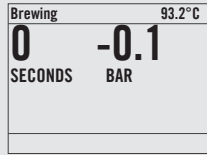

page 38

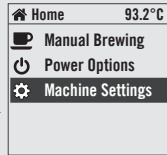

page 44



Press and hold the Encoder Knob for 5 seconds.

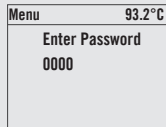

page 45

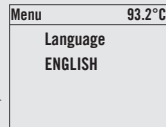

page 57

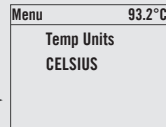

page 59

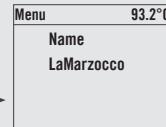

page 60

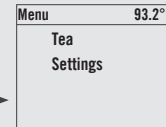

page 61

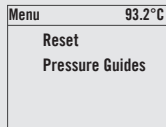

page 92

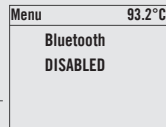

page 91

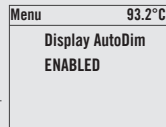

page 90

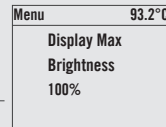

page 89

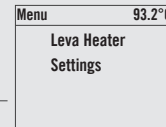

page 87

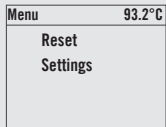

page 93

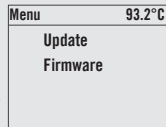

page 95

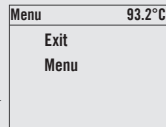

page 96

“Technical” Programming

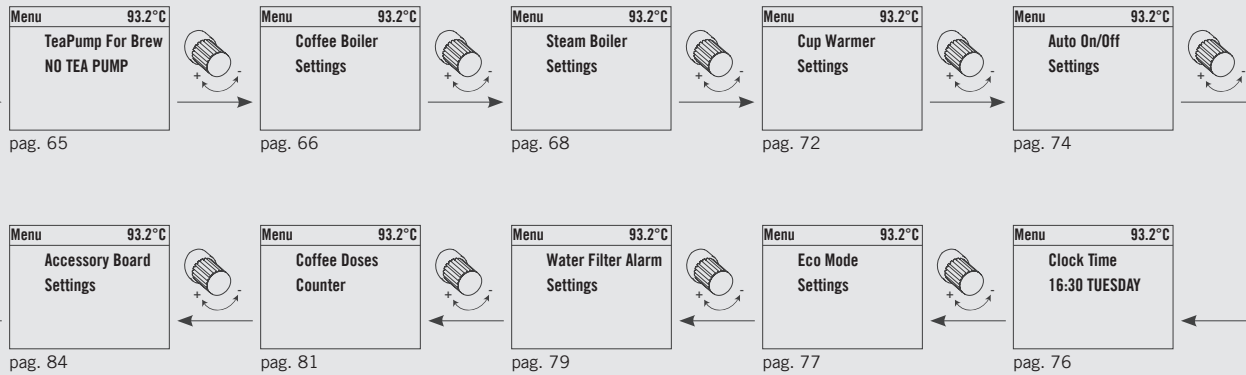

Programming Display

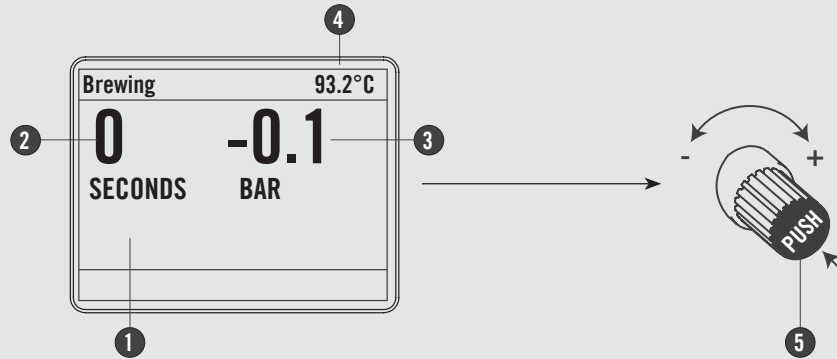

- 1 Graphic programming display with Encoder
 - 2 Delivery time
 - 3 Delivery pressure (bar)
 - 4 Coffee boiler temperature
 - 5 Encoder knob: Rotating to the right increases the value. Rotating to the left decreases the value. Pressing allows to browse the software menu, to access the functions or to confirm the first installation.
- You can turn on/off the LEVA espresso machine by pressing and holding the Encoder knob.

The display enables the operator to interact with the espresso machine to visibly change parameter values. The display also provides valuable information to the operator.

There are several warnings that can be displayed to alert the operator of an unusual condition or a fault. Additionally, simple messages are displayed alerting the operator that an action has been started or that a process needs to begin.

Turning the Espresso Machine On

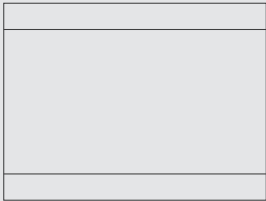



Description

The following is the procedure for turning on the power to the espresso machine.

- Please follow the procedures carefully to avoid any damage to the espresso machine.

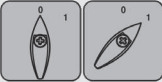
- Proceed checking for water connection to the espresso machine.
- Proceed making sure you have filled the boilers.

Display	Operating Procedure
	<ol style="list-style-type: none"> <li data-bbox="402 672 850 740"> <p>1 Turn the Main Switch to the 1 position.</p>  <li data-bbox="402 804 1524 833"> <p>2 The espresso machine is now on; temperature is displayed in red to indicate that warm-up is under way.</p>  <p>NOTE: Ensure all air is removed from the group prior to starting the espresso machine. This only needs to be completed once during the initial setup or when water is drained from the coffee boiler. Instructions for bleeding the groups of air can be found in the Installation Guide.</p>

⚠ WARNING ⚠
HAZARDOUS VOLTAGE DISCONNECT FROM POWER SUPPLY BEFORE SERVICING

Shut Down Procedures

Turning the Espresso Machine Off

Standby	93.2°C
OFF	00:00

Description

The following is the procedure for turning off power to the espresso machine.

- Please follow the procedures carefully to avoid any damage to the espresso machine.

- This machine has two off settings. One setting turns off all of the components in the espresso machine and the other turns off power to the complete espresso machine.

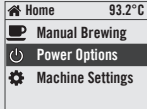
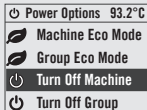
Display	Operating Procedure
	<p>1 The following is the procedure for safely turning off the espresso machine.</p>
	<p>2 Rotate the Encoder Knob until the following display appears.</p>
	<p>3 Press the Encoder Knob until the following display appears.</p>
	<p>Press the Encoder Knob; the following will be displayed: You can turn off the group only, by selecting Turn Off Group</p>
	<p>4</p>

⚠ WARNING ⚠

HAZARDOUS VOLTAGE DISCONNECT FROM POWER SUPPLY BEFORE SERVICING

Shut Down Procedures

Turning the Espresso Machine Off

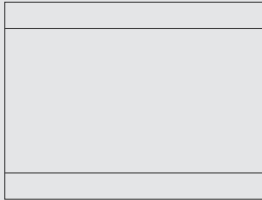

Description

The following is the procedure for turning off power to the espresso machine.

- Please follow the procedures carefully to avoid any damage to the espresso machine.

- This machine has two off settings. One setting turns off all of the components in the espresso machine and the other turns off power to the complete espresso machine.

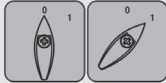
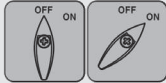
Display	Operating Procedure				
<table border="1"> <tr> <td>Standby</td> <td>93.2°C</td> </tr> <tr> <td>OFF</td> <td>00:00</td> </tr> </table>	Standby	93.2°C	OFF	00:00	<p>5 This is the OFF setting used in the normal operating conditions.</p> <p>During servicing or other conditions that warrant it, the main switch should be turned to the OFF position.</p> <p>6 The espresso machine is off and display should be blank. It is important to follow this procedure when turning off the machine. Failure to do so can damage the electronics.</p> <div style="text-align: center;">   </div>
Standby	93.2°C				
OFF	00:00				



WARNING



**HAZARDOUS VOLTAGE DISCONNECT FROM POWER
SUPPLY BEFORE SERVICING**

Eco Mode switch-off procedures

Switching off the Eco Mode espresso machine

Eco Mode	93.2°C
ECO	00:00

Description

The one described below is the switch-off procedure for the espresso machine in ECO mode.

- Carefully follow the procedure, to avoid any risk of damaging the espresso machine.

- This machine features two switch-off modes. One mode switches off all the machine internal components, while the other only switches off the selected group.

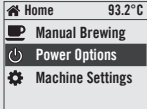
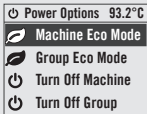
Display	Operating Procedure
	<p>1 The one described below is the procedure to be followed to switch off the espresso machine in ECO mode.</p>
	<p>2 Rotate the Encoder Knob until the following display appears.</p> <p>3 Press the Encoder Knob until the following display appears.</p>
	<p>Press the Encoder Knob. The following will be displayed: You can turn off the group only, by selecting Group Eco Mode</p> <p>4</p>

⚠ WARNING ⚠
HAZARDOUS VOLTAGE DISCONNECT FROM POWER
SUPPLY BEFORE SERVICING

Eco Mode switch-off procedures

Switching off the Eco Mode espresso machine

Eco Mode	93.2°C
ECO	00:00

Description

The one described below is the switch-off procedure for the espresso machine in ECO mode.

- Carefully follow the procedure, to avoid any risk of damaging the espresso machine.

- This machine features two switch-off modes. One mode switches off all the machine internal components, while the other only switches off the selected group.

Display	Operating Procedure						
<table border="1"> <tr> <td>Standby</td> <td>93.2°C</td> </tr> <tr> <td>ECO</td> <td>00:00</td> </tr> <tr> <td> </td> <td> </td> </tr> </table>	Standby	93.2°C	ECO	00:00			<p>5 This is the OFF setting used in the normal operating conditions.</p>
Standby	93.2°C						
ECO	00:00						

⚠ WARNING ⚠
HAZARDOUS VOLTAGE DISCONNECT FROM POWER
SUPPLY BEFORE SERVICING

Accessing Programming Mode

Programming Mode

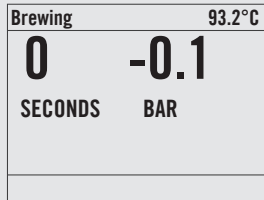

Description

- To change the values of any parameter the operator must first enter into the programming mode.
- There are two levels within the programming mode that allow the programming of specific parameters.
- The two programming levels are as follows:
- **Barista Programming** - The parameters contained within this level are ones the

operator can change to affect the quality of the espresso.

No password is required for access.

- **Technical Programming** - The parameters contained within this level are ones the operator can change to affect the performance of the espresso machine. These parameters are set in the factory and their adjustment requires the intervention of a service technician La

Display	Operating Procedure
	<p>1 While the espresso machine is on, rotate the Encoder Knob until the following display appears.</p>
	<p>2 Press the Encoder Knob until the following display appears.</p>
	<p>Press the Encoder Knob to access the “Barista” programming menu.</p> <p>3 Press and hold the Encoder Knob. After about 5 seconds the “Technician” programming display will appear. (see point 5)</p>
	<p>4 This is the “Barista” programming level. To set the coffee boilers, to enable/disable the resistance of the cup warmer if present, and etc..</p>

Programming Mode

Brewing	93.2°C
0	-0.1
SECONDS	BAR

Description

Marzocco recommends that no changes are made at this level. The Technician Password is required for access.

Display	Operating Procedure						
<table border="1"> <tr> <td>Menu</td> <td>93.2°C</td> </tr> <tr> <td>Enter Password</td> <td></td> </tr> <tr> <td>0000</td> <td></td> </tr> </table>	Menu	93.2°C	Enter Password		0000		<p>5 This is the “Technical” programming level. Using the Encoder Knob to move between the available parameters, press the Encoder Knob to confirm.</p> <p>You must scroll to the exit menu to exit the programming mode, or press the Encoder Knob for 2 seconds.</p>
Menu	93.2°C						
Enter Password							
0000							
<table border="1"> <tr> <td>Menu</td> <td>93.2°C</td> </tr> <tr> <td>Exit</td> <td></td> </tr> <tr> <td>Menu</td> <td></td> </tr> </table>	Menu	93.2°C	Exit		Menu		
Menu	93.2°C						
Exit							
Menu							

“Barista” Programming

Tea Dose

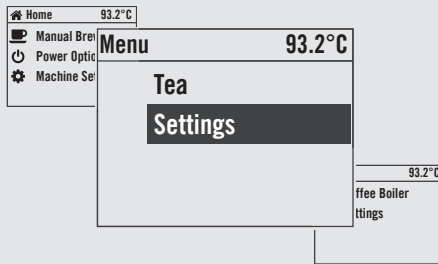

Description

- This parameter allows the operator to program the amount of water (brewing amount) for the tea button.
- This feature can be enabled or disabled.

Display	Operating Procedure
	<ol style="list-style-type: none"> 1 After accessing the "Barista" programming menu, rotate the Encoder Knob until the following is displayed.
	<ol style="list-style-type: none"> 2 Press the Encoder Knob to access the menu.
	<ol style="list-style-type: none"> 3 Press the Encoder Knob to access the menu, rotate the Encoder Knob to choose between ENABLED and DISABLED, press the Encoder Knob to confirm the option.
	<ol style="list-style-type: none"> 4 Press the Encoder Knob to access the menu, rotate the Encoder Knob to modify the value, press the Encoder Knob to confirm the desired value.

“Barista” Programming

Tea Dose

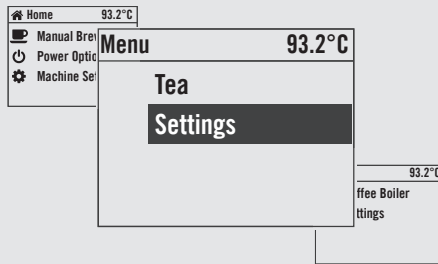

Description

- This parameter allows the operator to program the amount of water (brewing amount) for the tea button.
- This feature can be enabled or disabled.

Display	Operating Procedure
	5 Press the Encoder Knob to access the menu, rotate the Encoder Knob to modify the value, press the Encoder Knob to confirm the desired value.
	6 Press the Encoder Knob to start the tea button programming.
	7 Press the Encoder Knob to start the tea button programming.
	8 Press the tea button to start programming the desired dose.

“Barista” Programming

Tea Dose

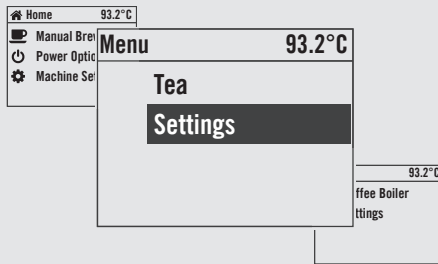

Description

- This parameter allows the operator to program the amount of water (brewing amount) for the tea button.
- This feature can be enabled or disabled.

Display	Operating Procedure
	<p>8 Once the desired dose has been reached, press the tea button again to stop the programming. Now the brewing time is saved.</p> <p>9 Press the Encoder Knob to quit the submenu.</p> <p>10 You must scroll to the exit menu to exit the programming mode, or press the Encoder Knob for 2 seconds.</p>

“Barista” Programming

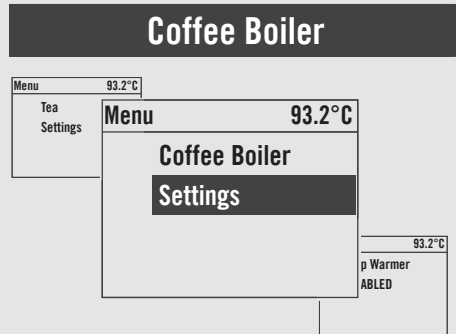

Description

- This parameter allows the operator to enable/disable the coffee boilers.
- This parameter allows the operator to program the coffee boiler temperature.
- For an espresso machine with multiple boilers, you can set the temperature for each group.

Display	Operating Procedure
	<p>1 After accessing the "Barista" programming menu, rotate the Encoder Knob until the following is displayed.</p>
	<p>2 Press the Encoder Knob to access the menu.</p>
	<p>3 Press the Encoder Knob to access the menu, rotate the Encoder Knob to choose between ENABLED and DISABLED, press the Encoder Knob to confirm the option.</p>
	<p>4 Press the Encoder Knob to access the menu, rotate the Encoder Knob to modify the value, press the Encoder Knob to confirm the desired value.</p>

“Barista” Programming

Coffee Boiler

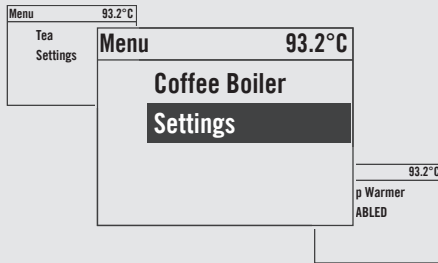

Description

- This parameter allows the operator to enable/disable the coffee boilers.
- This parameter allows the operator to program the coffee boiler temperature.
- For an espresso coffee machine composed of multiple boilers you can set the temperature for each group.

Display	Operating Procedure
<p>Menu 93.2°C Coffee Boiler Exit</p>	<p>5 Press the Encoder Knob to quit the submenu.</p>
<p>Menu 93.2°C Exit Menu</p>	<p>6 You must scroll to the exit menu to exit the programming mode, or press the Encoder Knob for 2 seconds.</p>

“Barista” Programming

Cup Warmer

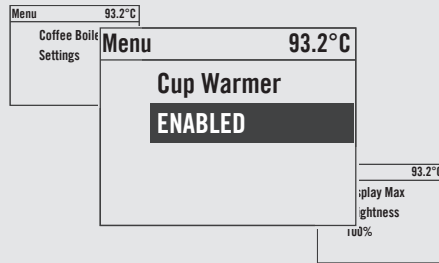

Description

- This parameter allows the operator to enable or disable the cups heating function.
- This function is displayed only on the models of espresso machine equipped with this accessory.

Display	Operating Procedure
	<ol style="list-style-type: none"> 1 After accessing the "Barista" programming menu, rotate the Encoder Knob until the following is displayed.
	<ol style="list-style-type: none"> 2 Press the Encoder Knob to access the menu, rotate the Encoder Knob to choose between ENABLED and DISABLED, press the Encoder Knob to confirm the option. 3 You must scroll to the exit menu to exit the programming mode, or press the Encoder Knob for 2 seconds.

“Barista” Programming

Display Brightness

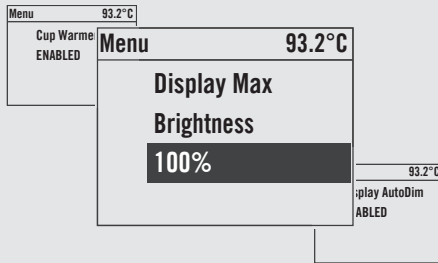

Description

- This parameter allows the operator to adjust the brightness of the screen.

Display	Operating Procedure
	<ol style="list-style-type: none"> 1 After accessing the “Barista” programming menu, rotate the Encoder Knob until the following is displayed. 2 Press the Encoder Knob to access the menu, rotate the Encoder Knob to modify the value, press the Encoder Knob to confirm the desired value. 3 You must scroll to the exit menu to exit the programming mode, or press the Encoder Knob for 2 seconds.

“Barista” Programming

Display AutoDim

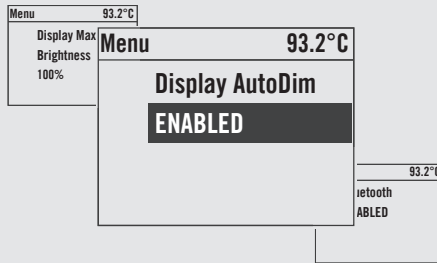

Description

- This parameter allows the operator to set the reduction of the screen brightness after a period of inactivity of the machine.
- This feature can be enabled or disabled.

Display	Operating Procedure
	<ol style="list-style-type: none"> 1 After accessing the “Barista” programming menu, rotate the Encoder Knob until the following is displayed.
	<ol style="list-style-type: none"> 2 Press the Encoder Knob to access the menu, rotate the Encoder Knob to modify the value, press the Encoder Knob to confirm the desired value.
	<ol style="list-style-type: none"> 3 Premere la Manopola Encoder per entrare nel menu, ruotare la Manopola Encoder per modificare il valore, premere la Manopola Encoder per confermare il valore desiderato.
	<ol style="list-style-type: none"> 4 You must scroll to the exit menu to exit the programming mode, or press the Encoder Knob for 2 seconds.

“Barista” Programming

Bluetooth

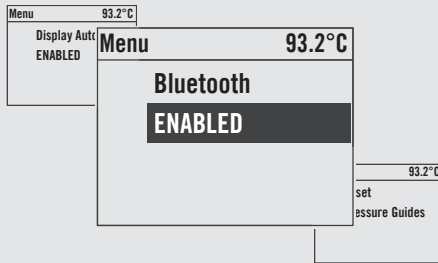

Description

- This parameter allows the operator to enable or disable the Bluetooth function.

Display	Operating Procedure
<p>The 'Display' column contains three screenshots showing the navigation path: 1. Home screen with 'Machine Settings' selected. 2. Bluetooth menu showing 'ENABLED'. 3. Exit menu.</p>	<ol style="list-style-type: none"> 1 After accessing the "Barista" programming menu, rotate the Encoder Knob until the following is displayed. 2 Press the Encoder Knob to access the menu, rotate the Encoder Knob to choose between ENABLED and DISABLED, press the Encoder Knob to confirm the option. 3 You must scroll to the exit menu to exit the programming mode, or press the Encoder Knob for 2 seconds.

“Barista” Programming

Reset Pressure Guides

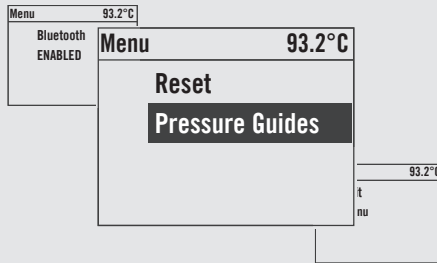

Description

- This parameter allows the operator to reset the pressure guide profiles to the original factory settings.

Display	Operating Procedure
	<ol style="list-style-type: none"> After accessing the “Barista” programming menu, rotate the Encoder Knob until the following is displayed. Press the Encoder Knob to reset the settings. Reset in progress. You must scroll to the exit menu to exit the programming mode, or press the Encoder Knob for 2 seconds.

“Barista” Programming

Exit Menu

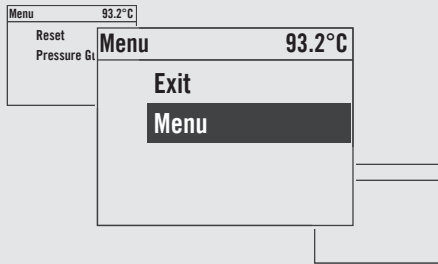

Description

- This parameter allows the technician to exit the “Barista” programming and return to the normal use of the espresso machine.

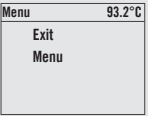
Display	Operating Procedure
	<ol style="list-style-type: none"> 1 Press the Encoder Knob to exit the programming mode and return to the normal use of the espresso machine.

“Technical” Programming

Language

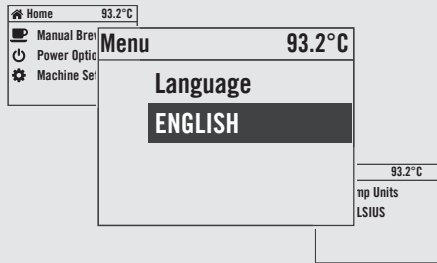

Description

- This parameter allows the technician to change the language of the display.

Display	Operating Procedure
	<p>1 When the espresso machine is on, rotate the Encoder Knob until the following is displayed.</p>
	<p>2 Press the Encoder Knob until it the following is displayed.</p>
	<p>3 Press and hold the Encoder Knob. After about 5 seconds the following screen is displayed.</p>
	<p>4 After entering the password and accessing the "Technician" programming menu, rotate the Encoder Knob until the following is displayed.</p>

“Technical” Programming

Language

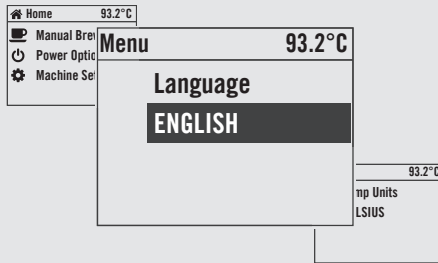

Description

- This parameter allows the technician to change the language of the display.

Display	Operating Procedure
	<p>5 Press the Encoder Knob to access the parameter, rotate the Encoder Knob to choose the desired language, press the Encoder Knob to confirm your choice.</p>
	<p>6 You must scroll to the exit menu to exit the programming mode, or press the Encoder Knob for 2 seconds.</p>

Temperature Measurement Units

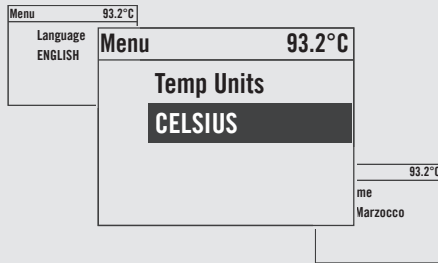

Description

- This parameter allows the technician to change the temperature display from degrees Celsius to degrees Fahrenheit and vice versa.

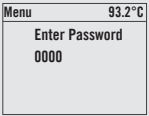
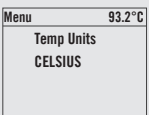
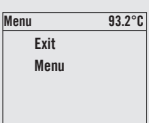
Display	Operating Procedure
	<ol style="list-style-type: none"> 1 After entering the password and accessing the "Technician" programming menu, rotate the Encoder Knob until the following is displayed.
	<ol style="list-style-type: none"> 2 Press the Encoder Knob to access the menu, rotate the Encoder Knob to choose the desired option, press the Encoder Knob to confirm the option.
	<ol style="list-style-type: none"> 3 You must scroll to the exit menu to exit the programming mode, or press the Encoder Knob for 2 seconds.

“Technical” Programming

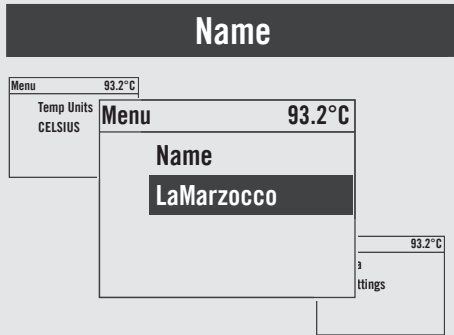

Description

- This parameter allows the technician to program a 16 character user name.
- The user name is displayed continuously on the display on the second line.

Display	Operating Procedure
	<ol style="list-style-type: none"> 1 After entering the password and accessing the "Technician" programming menu, rotate the Encoder Knob until the following is displayed.
	<ol style="list-style-type: none"> 2 Press the Encoder Knob to access the menu, rotate the Encoder Knob to choose the desired letter, press the Encoder Knob to confirm your choice, then proceed with the writing operations.
	<ol style="list-style-type: none"> 3 You must scroll to the exit menu to exit the programming mode, or press the Encoder Knob for 2 seconds.

“Technical” Programming

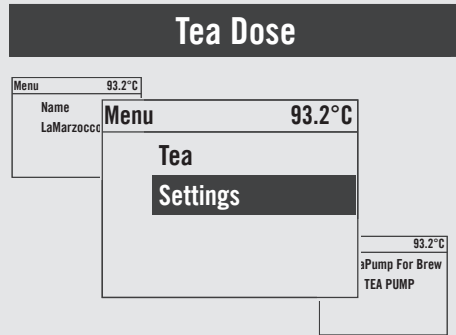

Description

- This parameter allows the operator to program the amount of water (brewing amount) for the tea button.
- This feature can be enabled or disabled.

Display	Operating Procedure
	1 After entering the password and accessing the "Technician" programming menu, rotate the Encoder Knob until the following is displayed.
	2 Press the Encoder Knob to access the menu.
	3 Press the Encoder Knob to access the menu, rotate the Encoder Knob to choose between WITH PUMP and WITHOUT PUMP , press the Encoder Knob to confirm the option.
	4 Press the Encoder Knob to access the menu, rotate the Encoder Knob to choose between ENABLED and DISABLED , press the Encoder Knob to confirm the option.

“Technical” Programming

Tea Dose

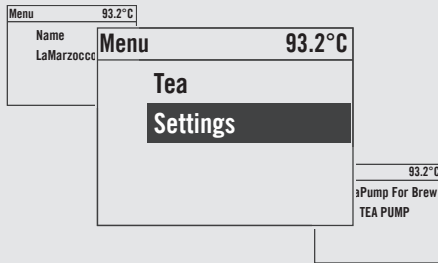

Description

- This parameter allows the operator to program the amount of water (brewing amount) for the tea button.
- This feature can be enabled or disabled.

Display	Operating Procedure
<p>Menu 93.2°C</p> <p>Tea Dose 15.0 s</p>	<p>5 Press the Encoder Knob to access the menu, rotate the Encoder Knob to modify the value, press the Encoder Knob to confirm the desired value.</p>
<p>Menu 93.2°C</p> <p>Tea Long Dose 15.0 s</p>	<p>6 Press the Encoder Knob to access the menu, rotate the Encoder Knob to modify the value, press the Encoder Knob to confirm the desired value.</p>
<p>Menu 93.2°C</p> <p>Program Tea Dose</p>	<p>7 Press the Encoder Knob to start the tea button programming.</p>
<p>Menu 93.2°C</p> <p>Program Long Tea Dose</p>	<p>8 Press the Encoder Knob to start the tea button programming.</p>

“Technical” Programming

Tea Dose

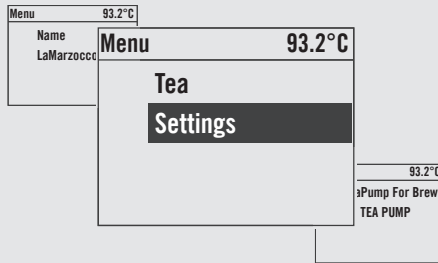

Description

- This parameter allows the operator to program the amount of water (brewing amount) for the tea button.
- This feature can be enabled or disabled.

Display	Operating Procedure
Menu 93.2°C Press Tea Button To Program	9 Press the tea button to start programming the desired dose.
Menu 93.2°C Press Tea Button To Stop	10 Once the desired dose has been reached, press the tea button again to stop the programming. Now the brewing time is saved.
Menu 93.2°C Saving Tea Dose	
Menu 93.2°C Tea Exit	11 Press the Encoder Knob to quit the submenu.

“Technical” Programming

Tea Dose

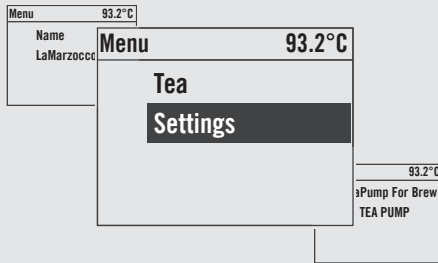

Description

- This parameter allows the operator to program the amount of water (brewing amount) for the tea button.
- This feature can be enabled or disabled.

Display	Operating Procedure
<p>The screenshot shows a screen with 'Menu' at the top right and '93.2°C' at the top left. Below, there are two options: 'Exit' and 'Menu'.</p>	<p>12 You must scroll to the exit menu to exit the programming mode, or press the Encoder Knob for 2 seconds.</p>

“Technical” Programming

Coffee Brewing

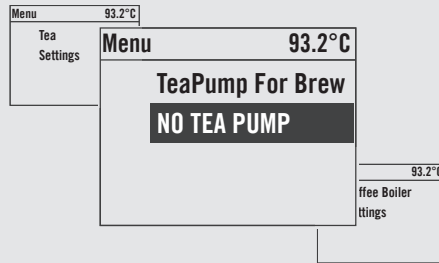

Description

- The parameter coffee brewing WITH PUMP allows the technician to select the activation of the water pump during the coffee brewing cycle.

Display	Operating Procedure
	<ol style="list-style-type: none"> 1 After entering the password and accessing the “Technician” programming menu, rotate the Encoder Knob until the following is displayed.
	<ol style="list-style-type: none"> 2 Press the Encoder Knob to access the menu, rotate the Encoder Knob to choose between USE TEA PUMP and NO TEA PUMP, press the Encoder Knob to confirm the option.
	<ol style="list-style-type: none"> 3 You must scroll to the exit menu to exit the programming mode, or press the Encoder Knob for 2 seconds.

“Technical” Programming

Coffee Boiler

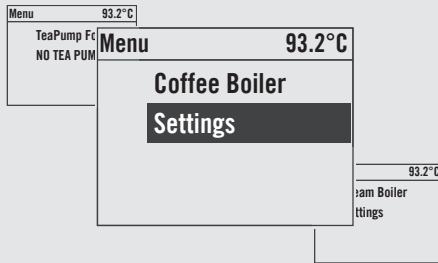

Description

- This parameter enables the technician to set various parameters of the coffee boiler.
- The boiler temperature is measured in the boiler's most critical point, where the temperature fluctuation is the largest.
- The temperature of the water inside the group head is kept constant by the group mass. Though the boiler temperature

may fluctuate slightly, that of the water inside the group is constant.

- In order to properly calibrate the temperature of each espresso, it is important that you measure the temperature of the water inside the group using an external temperature measuring device. The difference between the temperature shown on the display and the measured temperature can be compensated with the “Coffee T. offset” parameter.
- The OFFSET parameter is used to

Display	Operating Procedure
	1 After entering the password and accessing the "Technician" programming menu, rotate the Encoder Knob until the following is displayed.
	2 Press the Encoder Knob to access the menu.
	3 Press the Encoder Knob to access the menu, rotate the Encoder Knob to choose between ENABLED and DISABLED , press the Encoder Knob to confirm the option.
	4 Press the Encoder Knob to access the menu, rotate the Encoder Knob to modify the value, press the Encoder Knob to confirm the desired value.

“Technical” Programming

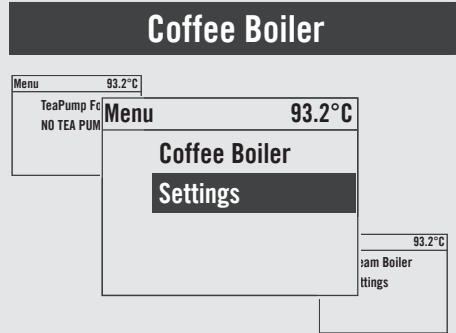

Description

calibrate the coffee boiler system temperature, to ensure that the displayed temperature exactly corresponds to the temperature of the water in the group head.

- This parameter is factory preset according to the results of the initial tests on this espresso machine.
- We recommend that you don't change this value.

- Changing this value might lead to unexpected results.
- It is important that you take note of this value before you make any change, to ensure that you can restore the factory settings in case of unexpected results. Each machine might have a different value, as they are set individually.

Display	Operating Procedure
	<p>5 Press the Encoder Knob to access the menu, rotate the Encoder Knob to modify the value, press the Encoder Knob to confirm the desired value.</p>
	<p>6 Press the Encoder Knob to quit the submenu.</p>
	<p>7 You must scroll to the exit menu to exit the programming mode, or press the Encoder Knob for 2 seconds.</p>

⚠ DANGER ⚠
**THE COFFEE BOILER CONTAINS WATER AT ELEVATED TEMPERATURES.
 WATER TEMPERATURE OVER 52°C CAN CAUSE SEVERE BURNS IN STANTLY OR DEATH FROM SCALDING.**

“Technical” Programming

Steam Boiler

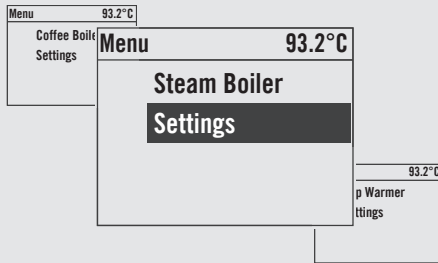

Description

- This parameter enables the technician to set various parameters of the steam boiler.
- The temperature of saturated water is proportional to the pressure inside the Steam Boiler. Therefore it is possible to regulate the pressure of the steam boiler by means of electronic temperature control. Please use the following tables as reference when setting the steam boiler temperature.
- The maximum permitted value for the temperature setting is 129°C.
- The parameter filling WITH PUMP allows the technician to select the activation of the water pump during the automatic filling cycle of the service boiler.
- Only under unusual circumstances would the option of “WITHOUT PUMP” be chosen.

Display	Operating Procedure
	1 After entering the password and accessing the "Technician" programming menu, rotate the Encoder Knob until the following is displayed.
	2 Press the Encoder Knob to access the menu.
	3 Press the Encoder Knob to access the menu, rotate the Encoder Knob to choose between ENABLED and DISABLED , press the Encoder Knob to confirm the option.
	4 Press the Encoder Knob to access the menu, rotate the Encoder Knob to modify the value, press the Encoder Knob to confirm the desired value.

“Technical” Programming

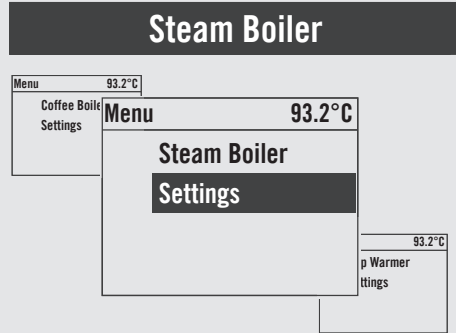

Description

- The electronics installed in this espresso machine give priority to the brew boiler for pressure. The activation of the auto-fill cycle during the brewing process can reduce the overall dispensing pressure in the brew boiler.
 - During the auto-fill cycle, if a brew cycle is chosen, the auto-fill cycle is delayed until all brew cycles are complete.
- SAFETY TEST allows to bring the steam

- boiler temperature to 140°C, thus triggering the safety valve. Once the valve has triggered disable the function.
- Should the safety valve fail to trigger within approximately one minute of the temperature reaching 140°C, disable the function and replace the valve.
- Only qualified technicians can perform this operation.

Display	Operating Procedure
<p>Menu 93.2°C</p> <p>Autofill Delay 2s start 2s stop</p>	<p>5 The first value indicates the time in seconds between the detection of the need to fill and the start of filling. The second value indicates the time in seconds between filling and its actual end. Press the Encoder Knob to access the menu, rotate the Encoder Knob to set the desired automatic filling time, press the Encoder Knob to confirm the desired value.</p>
<p>Menu 93.2°C</p> <p>Fill During Brew YES</p>	<p>6 Press the Encoder Knob to access the menu, rotate the Encoder Knob to choose between YES and NO, press the Encoder Knob to confirm the option.</p>
<p>Menu 93.2°C</p> <p>Autofill Timeout 10</p>	<p>7 Press the Encoder Knob to access the menu, rotate the Encoder Knob to set the desired time, press the Encoder Knob to confirm the option.</p>
<p>Menu 93.2°C</p> <p>Fill With Pump WITH PUMP</p>	<p>8 Press the Encoder Knob to access the menu, rotate the Encoder Knob to choose between WITH PUMP and WITHOUT PUMP, press the Encoder Knob to confirm the option.</p>

“Technical” Programming

Steam Boiler

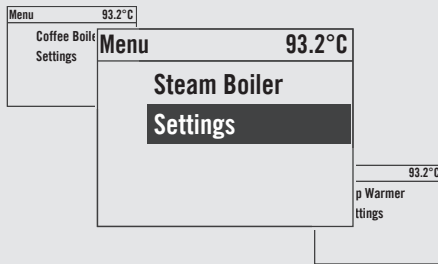

Description

- DRAIN STEAM BOILER allows the service staff to renew or “regenerate” the water contained inside the steam boiler, discharging about one half of the water contained in the boiler.
- This procedure is recommended in case the machine should remain inactive for more than 8 hours and in any case at least on a weekly basis.

Display	Operating Procedure
Menu 93.2°C Level Sensitivity HIGH	9 Press the Encoder Knob to access the menu, rotate the Encoder Knob to choose between HIGH, LOW or MEDIUM , press the Encoder Knob to confirm the option.
Menu 93.2°C Start Steam Boiler Safety Test	10 Press the Encoder Knob to quit the submenu.
Menu 93.2°C Drain Steam Boiler	11 Press the Encoder Knob to enable the function.
Menu 93.2°C Close Tea Valve Enter when Ready	12 Manually close the mixing valve to allow the drain of the water contained in the steam boiler.

Steam Boiler

Description

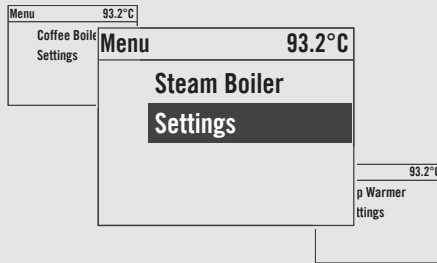

Display	Operating Procedure
<p>Menu 93.2°C</p> <p>Press Tea Button Enter when Empty</p>	<p>13 Press the tea button to start draining the water contained in the steam boiler. Press the Encoder Knob when the boiler is empty, wait for refilling completion.</p>
<p>Menu 93.2°C</p> <p>Reset Tea Valve Enter when Done</p>	<p>14 Manually reopen the mixing valve and press the Encoder Knob. Now the procedure to renew or “regenerate” the water inside the steam boiler is completed</p>
<p>Menu 93.2°C</p> <p>Steam Boiler Exit</p>	<p>15 Press the Encoder Knob to quit the submenu.</p>
<p>Menu 93.2°C</p> <p>Exit Menu</p>	<p>16 You must scroll to the exit menu to exit the programming mode, or press the Encoder Knob for 2 seconds.</p>

“Technical” Programming

Cup Warmer

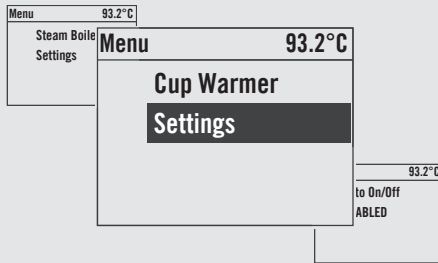

Description

- This parameter allows the technician to enable or disable the cups heating function.
- This parameter allows the technician to adjust the operating time of the resistance for the heating of the cups.
- This function is displayed only on the models of espresso machine equipped with this accessory.
- In TIME mode it is possible also to stop and to restart the cycle of the cup warmer by pushing the cup warmer button.

Display	Operating Procedure
<p>Menu 93.2°C</p> <p>Enter Password 0000</p>	<p>1 After entering the password and accessing the "Technician" programming menu, rotate the Encoder Knob until the following is displayed.</p>
<p>Menu 93.2°C</p> <p>Cup Warmer Settings</p>	<p>2 Press the Encoder Knob to access the menu.</p>
<p>Menu 93.2°C</p> <p>Cup Warmer ENABLED</p>	<p>3 Press the Encoder Knob to access the menu, rotate the Encoder Knob to choose between ENABLED and DISABLED, press the Encoder Knob to confirm the option.</p>
<p>Menu 93.2°C</p> <p>Cup Warmer On Time: 2 min Off Time: 8 min</p>	<p>4 Press the Encoder Knob to access the menu, rotate the Encoder Knob to set the desired time, press the Encoder Knob to confirm the option.</p>

“Technical” Programming

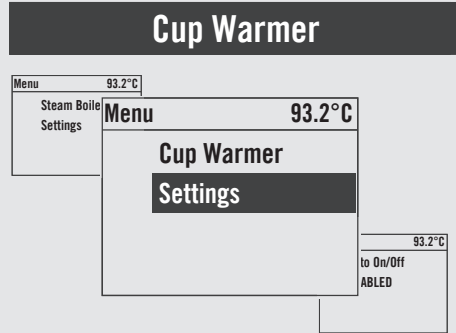

Description

- This parameter allows the technician to enable or disable the cups heating function.
- This parameter allows the technician to adjust the operating time of the resistance for the heating of the cups.
- This function is displayed only on the models of espresso machine equipped with this accessory.
- In TIME mode it is possible also to stop and to restart the cycle of the cup warmer by pushing the cup warmer button.

Display	Operating Procedure
Menu 93.2°C Cup Warmer Mode TIME	5 Press the Encoder Knob to access the menu, rotate the Encoder Knob to choose between TIME and BY BUTTON , press the Encoder Knob to confirm the option.
Menu 93.2°C Cup Warmer On Time: 5 min Off Time: 5 min	6 You must scroll to the exit menu to exit the programming mode, or press the Encoder Knob for 2 seconds.
Menu 93.2°C Cup Warmer Exit	7 Press the Encoder Knob to quit the submenu.
Menu 93.2°C Exit Menu	8 You must scroll to the exit menu to exit the programming mode, or press the Encoder Knob for 2 seconds.

“Technical” Programming

Auto ON/OFF

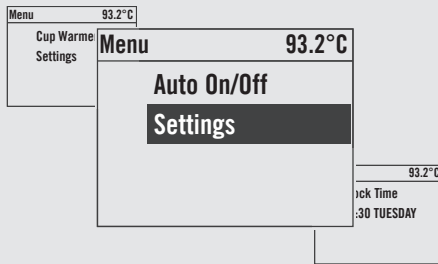

Description

- This parameter allows the technician to program the espresso machine to turn on at a preset time and turn off at a preset time.
- This feature also allows the espresso machine to remain in the off condition for one repeating closed day.

Display	Operating Procedure
<p>Menu 93.2°C</p> <p>Enter Password 0000</p>	<p>1 After entering the password and accessing the “Technician” programming menu, rotate the Encoder Knob until the following is displayed.</p>
<p>Menu 93.2°C</p> <p>Auto On/Off Settings</p>	<p>2 Press the Encoder Knob to access the menu.</p>
<p>Menu 93.2°C</p> <p>Auto On/Off ENABLED</p>	<p>3 Press the Encoder Knob to access the menu, rotate the Encoder Knob to choose between ENABLED and DISABLED, press the Encoder Knob to confirm the option.</p>
<p>Menu 93.2°C</p> <p>On Time 00:00</p>	<p>4 Press the Encoder Knob to access the menu, rotate the Encoder Knob to modify the value, press the Encoder Knob to confirm the desired value.</p>

“Technical” Programming

Auto ON/OFF

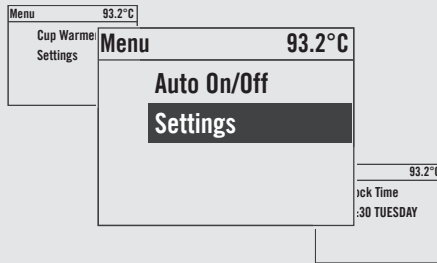

Description

- This parameter allows the technician to program the espresso machine to turn on at a preset time and turn off at a preset time.
- This feature also allows the espresso machine to remain in the off condition for one repeating closed day.

Display	Operating Procedure
	5 Press the Encoder Knob to access the menu, rotate the Encoder Knob to modify the value, press the Encoder Knob to confirm the desired value.
	6 Press the Encoder Knob to enter the menu, rotate the Encoder Knob to select an option, press the Encoder Knob to confirm the option.
	7 Press the Encoder Knob to quit the submenu.
	8 You must scroll to the exit menu to exit the programming mode, or press the Encoder Knob for 2 seconds.

“Technical” Programming

Clock Adjust

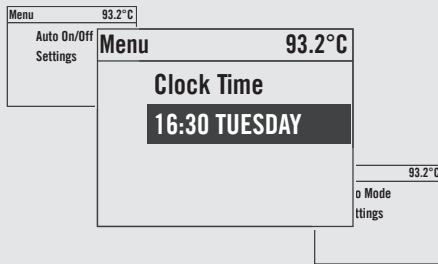

Description

- This parameter allows the user to set the time of day and the day of the week.
- This parameter is used to display time and is also used by the “Auto On/Off” parameter
- There are 4 changeable values within this parameter:
 - Hour;
 - Minute;
 - Day of week;
 - Hour Format 12h or 24h.

Display	Operating Procedure
	<p>1 After entering the password and accessing the "Technician" programming menu, rotate the Encoder Knob until the following is displayed.</p>
	<p>2 Press the Encoder Knob once to set the first value, rotate the Encoder Knob to set the desired time, press the Encoder Knob twice to set the minutes, rotate the Encoder Knob to set the desired value. Press the Encoder Knob thrice to set the day of the week, rotate the Encoder Knob to set the desired day.</p>
	<p>3 You must scroll to the exit menu to exit the programming mode, or press the Encoder Knob for 2 seconds.</p>

“Technical” Programming

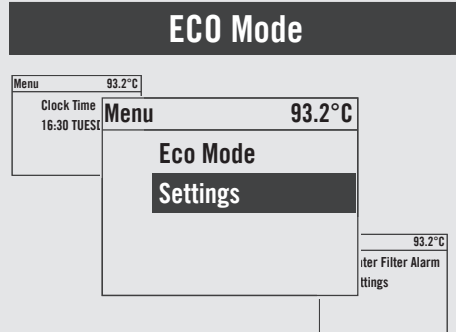

Description

- This parameter allows the technician to set up a temperature to be maintained in case of a temporary non utilization of the espresso machine.

Display	Operating Procedure
	1 After entering the password and accessing the "Technician" programming menu, rotate the Encoder Knob until the following is displayed.
	2 Press the Encoder Knob to access the menu.
	3 Press the Encoder Knob to access the menu, rotate the Encoder Knob to set the desired temperature, press the Encoder Knob to confirm the value.
	4 Press the Encoder Knob to access the menu, rotate the Encoder Knob to set the desired time in minutes, press the Encoder Knob to confirm the value. Setting the value to “0” (zero) will disable the Eco Mode parameter.

“Technical” Programming

ECO Mode

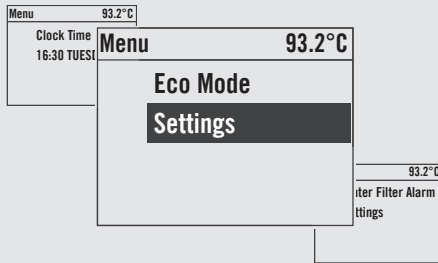

Description

- This parameter allows the technician to set up a temperature to be maintained in case of a temporary non utilization of the espresso machine.

Display	Operating Procedure
<p>Menu 93.2°C Eco Mode Exit</p>	<p>5 Press the Encoder Knob to quit the submenu.</p>
<p>Menu 93.2°C Exit Menu</p>	<p>6 You must scroll to the exit menu to exit the programming mode, or press the Encoder Knob for 2 seconds.</p>

“Technical” Programming

Filter Alarm

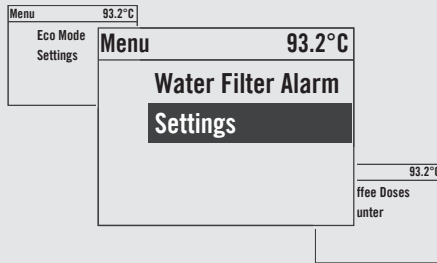

Description

- This parameter enables the technician to program an alarm that will alert the user about the need for maintenance or replacement of the water filter.
- Once the set volume has been reached, the error message “Filter Alarm” will be displayed.
- A value of 0 (zero) disables the filter alarm parameter.
- This feature can be enabled or disabled.

Display	Operating Procedure
	1 After entering the password and accessing the "Technician" programming menu, rotate the Encoder Knob until the following is displayed.
	2 Press the Encoder Knob to access the menu.
	3 Press the Encoder Knob to access the menu, rotate the Encoder Knob to choose between ENABLED and DISABLED , press the Encoder Knob to confirm the option.
	4 Press the Encoder Knob to enter the menu, rotate the Encoder Knob to set the desired value, press the Encoder Knob to confirm the value.

“Technical” Programming

Filter Alarm

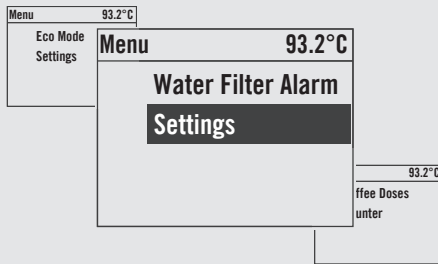

Description

- This parameter enables the technician to program an alarm that will alert the user about the need for maintenance or replacement of the water filter.
- Once the set volume has been reached, the error message “Filter Alarm” will be displayed.
- A value of 0 (zero) disables the filter alarm parameter.
- This feature can be enabled or disabled.

Display	Operating Procedure
<p>Menu 93.2°C</p> <p>Tea Percentage 40%</p>	<p>5 Press the Encoder Knob to enter the menu, rotate the Encoder Knob to set the desired value, press the Encoder Knob to confirm the value.</p>
<p>Menu 93.2°C</p> <p>Reset Filter Alarm</p>	<p>6 Press the Encoder Knob to reset the settings made.</p>
<p>Menu 93.2°C</p> <p>Water Filter Alarm Exit</p>	<p>7 Press the Encoder Knob to quit the submenu.</p>
<p>Menu 93.2°C</p> <p>Exit Menu</p>	<p>8 You must scroll to the exit menu to exit the programming mode, or press the Encoder Knob for 2 seconds.</p>

“Technical” Programming

Coffee Dose Counter

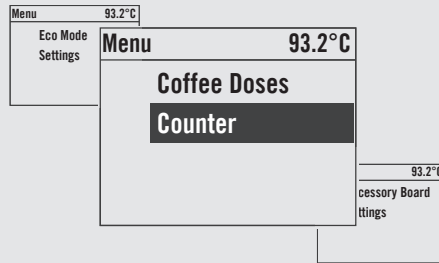

Description

- This parameter allows the technician to review the total doses dispensed for each button.
- This parameter displays different values:
 - Total coffee doses;
 - Coffee doses for each button;
 - Tea doses.

Display	Operating Procedure
Menu 93.2°C Enter Password 0000	1 After entering the password and accessing the "Technician" programming menu, rotate the Encoder Knob until the following is displayed.
Menu 93.2°C Coffee Doses Counter	2 Press the Encoder Knob to access the menu.
Menu 93.2°C Total Coffee Doses:14	3 Total dose display. Rotate the Encoder Knob to display the other doses.
Menu 93.2°C G1 Doses 6	4 Keep rotating the Encoder Knob to display the total doses of the individual groups.

“Technical” Programming

Coffee Dose Counter

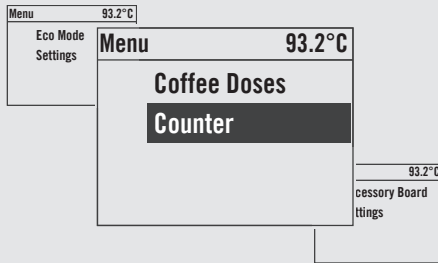

Description

- This parameter allows the technician to review the total doses dispensed for each button.
- This parameter displays different values:
 - Total coffee doses;
 - Coffee doses for each button;
 - Tea doses.

Display	Operating Procedure
Menu 93.2°C Left Steam Doses 4	
Menu 93.2°C Right Steam Doses 6	5 Keep rotating the Encoder Knob to display the total doses of the individual steam wands.
Menu 93.2°C Tea Dose 10	6 Keep rotating the Encoder Knob to also display the tea button doses.
Menu 93.2°C Coffee Doses Exit	7 Press the Encoder Knob to quit the submenu.

“Technical” Programming

Coffee Dose Counter

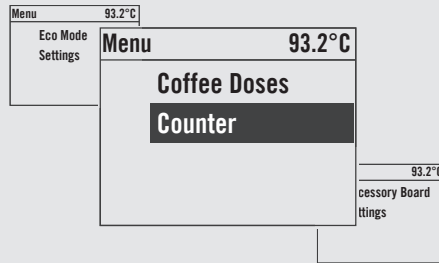

Description

- This parameter allows the technician to review the total doses dispensed for each button.
- This parameter displays different values:
 - Total coffee doses;
 - Coffee doses for each button;
 - Tea doses.

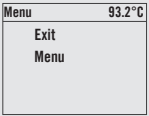
Display	Operating Procedure
	<p>8 You must scroll to the exit menu to exit the programming mode, or press the Encoder Knob for 2 seconds.</p>

“Technical” Programming

Displaying the Firmware

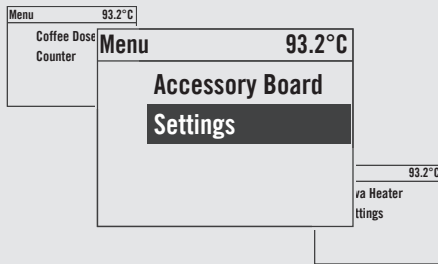

Description

- This parameter allows the technician to display the hardware and firmware version for all the electronic boards installed on the espresso machine.

Display	Operating Procedure
<p>Menu 93.2°C</p> <p>Enter Password 0000</p>	<p>1 After entering the password and accessing the "Technician" programming menu, rotate the Encoder Knob until the following is displayed.</p>
<p>Menu 93.2°C</p> <p>Accessory Board Settings</p>	<p>2 Press the Encoder Knob to access the menu.</p>
<p>Menu 93.2°C</p> <p>Force FW Upgrade On Next Startup DISABLED</p>	<p>3 Press the Encoder Knob to access the menu, rotate the Encoder Knob to choose between ENABLED and DISABLED, press the Encoder Knob to confirm the option.</p>
<p>Menu 93.2°C</p> <p>Steam Board FW v0.0.0 HW v2</p>	<p>4 Rotate the Encoder Knob to display the hardware and firmware version for the Steam Board.</p>

Displaying the Firmware

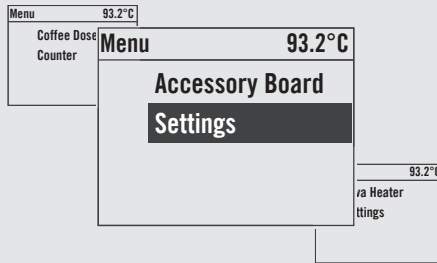

Description

- This parameter allows the technician to display the hardware and firmware version for all the electronic boards installed on the espresso machine.

Display	Operating Procedure
<p>Menu 93.2°C</p> <p>Strada EP Board FW v0.2.0 HW v2</p>	<p>5 Rotate the Encoder Knob to display the hardware and firmware version for the Strada EP Board.</p>
<p>Menu 93.2°C</p> <p>Universal Board HW v3</p>	<p>6 Rotate the Encoder Knob to display the hardware version for the Universal Board.</p>
<p>Menu 93.2°C</p> <p>G1 Display FW v0.7.0 HW v3</p>	<p>7 Rotate the Encoder Knob to display the hardware and firmware version for the Graphic Display Board of each individual group.</p>
<p>Menu 93.2°C</p> <p>Accessory Board Exit</p>	<p>8 Press the Encoder Knob to quit the submenu.</p>

“Technical” Programming

Displaying the Firmware

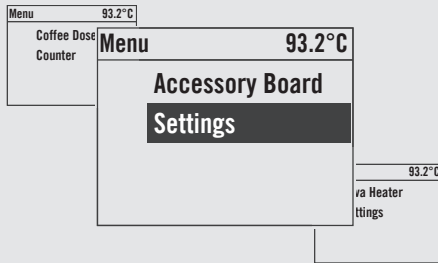

Description

- This parameter allows the technician to display the hardware and firmware version for all the electronic boards installed on the espresso machine.

Display	Operating Procedure
	<p>9 You must scroll to the exit menu to exit the programming mode, or press the Encoder Knob for 2 seconds.</p>

“Technical” Programming

Leva Heater

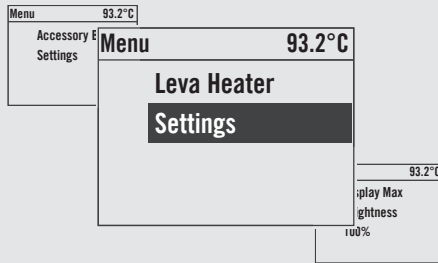

Description

- This parameter allows the technician to set the draw of the machine.
- **Advanced performance:** All the heating resistances of the Leva group can operate in simultaneous mode in addition to the other resistances of the machine.
- **Low power:** the draw of the machine is limited to boiler heating, even if the accessory resistances of the groups operate in an alternating manner.

Display	Operating Procedure
<p>Menu 93.2°C Enter Password 0000</p>	<p>1 After entering the password and accessing the "Technician" programming menu, rotate the Encoder Knob until the following is displayed.</p>
<p>Menu 93.2°C Leva Heater Settings</p>	<p>2 Press the Encoder Knob to access the menu.</p>
<p>Menu 93.2°C Heater Mode LOW POWER</p>	<p>3 Press the Encoder Knob to access the menu, rotate the Encoder Knob to choose between HIGH PERFORMANCE and LOW POWER, press the Encoder Knob to confirm the option.</p>
<p>Menu 93.2°C Leva Heater Exit</p>	<p>4 Press the Encoder Knob to quit the submenu.</p>

“Technical” Programming

Leva Heater

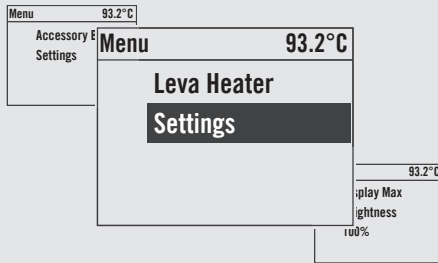

Description

- This parameter allows the technician to set the draw of the machine.
- **Advanced performance:** All the heating resistances of the Leva group can operate in simultaneous mode in addition to the other resistances of the machine.
- **Low power:** the draw of the machine is limited to boiler heating, even if the accessory resistances of the groups operate in an alternating manner.

Display	Operating Procedure
	<p>5 You must scroll to the exit menu to exit the programming mode, or press the Encoder Knob for 2 seconds.</p>

Display Brightness

Description

- This parameter allows the operator to adjust the brightness of the screen.

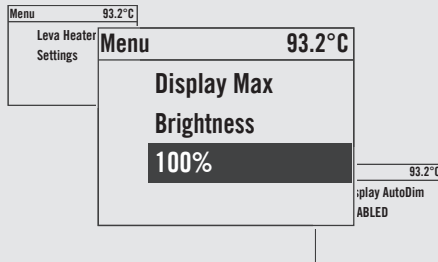

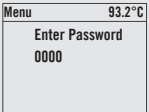
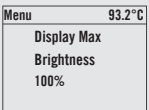
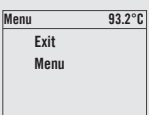
Display	Operating Procedure
	<ol style="list-style-type: none"> 1 After entering the password and accessing the "Technician" programming menu, rotate the Encoder Knob until the following is displayed. 2 Press the Encoder Knob to enter the menu, rotate the Encoder Knob to set the desired value, press the Encoder Knob to confirm the value. 3 You must scroll to the exit menu to exit the programming mode, or press the Encoder Knob for 2 seconds.
	
	

“Technical” Programming

Auto-Oscuro Schermo

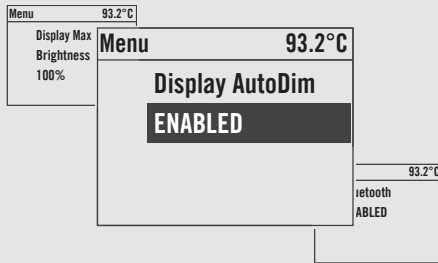

Description

- This parameter allows the operator to set the reduction of the screen brightness after a period of inactivity of the machine.
- This feature can be enabled or disabled.

Display	Operating Procedure
<p>Menu 93.2°C</p> <p>Enter Password 0000</p>	<ol style="list-style-type: none"> 1 After entering the password and accessing the "Technician" programming menu, rotate the Encoder Knob until the following is displayed. 2 Press the Encoder Knob to access the menu, rotate the Encoder Knob to choose between ENABLED and DISABLED, press the Encoder Knob to confirm the option. 3 Press the Encoder Knob to enter the menu, rotate the Encoder Knob to set the desired value, press the Encoder Knob to confirm the value. 4 You must scroll to the exit menu to exit the programming mode, or press the Encoder Knob for 2 seconds.
<p>Menu 93.2°C</p> <p>Display AutoDim ENABLED</p>	
<p>Menu 93.2°C</p> <p>Inactive Brightness 50%</p>	
<p>Menu 93.2°C</p> <p>Exit Menu</p>	

“Technical” Programming

Bluetooth

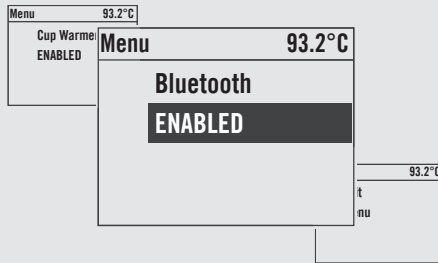

Description

- This parameter allows the technician to enable or disable the Bluetooth function.

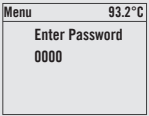
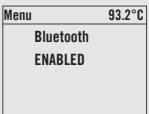
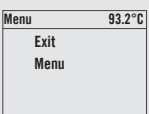
Display	Operating Procedure
	<ol style="list-style-type: none"> 1 After entering the password and accessing the "Technician" programming menu, rotate the Encoder Knob until the following is displayed.
	<ol style="list-style-type: none"> 2 Press the Encoder Knob to access the menu, rotate the Encoder Knob to choose between ENABLED and DISABLED, press the Encoder Knob to confirm the option.
	<ol style="list-style-type: none"> 3 You must scroll to the exit menu to exit the programming mode, or press the Encoder Knob for 2 seconds.

“Technical” Programming

Reset Pressure Guides

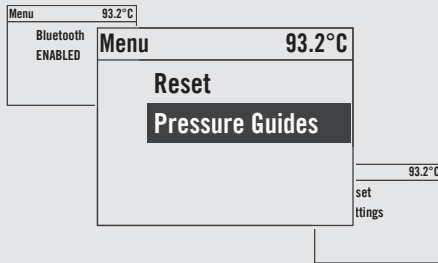

Description

- This parameter allows the operator to reset the pressure guide profiles to the original factory settings.

Display	Operating Procedure
<p>Menu 93.2°C</p> <p>Enter Password 0000</p>	<p>1 After entering the password and accessing the "Technician" programming menu, rotate the Encoder Knob until the following is displayed.</p>
<p>Menu 93.2°C</p> <p>Reset Pressure Guides</p>	<p>2 Press the Encoder Knob to reset the settings.</p>
<p>Menu 93.2°C</p> <p>Resetting Pressure Guides</p>	<p>3 Reset in progress.</p>
<p>Menu 93.2°C</p> <p>Exit Menu</p>	<p>4 You must scroll to the exit menu to exit the programming mode, or press the Encoder Knob for 2 seconds.</p>

“Technical” Programming

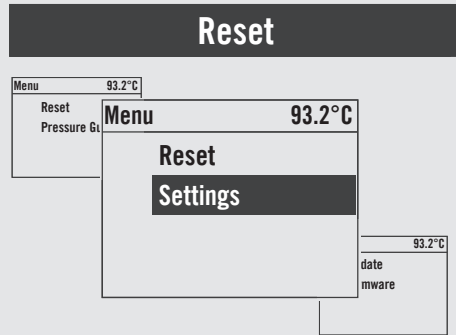

Description

- This parameter allows the technician to reset all the values returning to initial factory settings.
- It is possible to reset the settings you made in the “Barista” programming or the settings you made in the “Technical” programming.

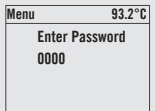
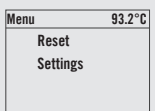
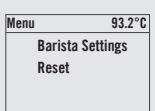
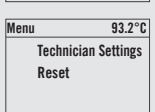
Display	Operating Procedure
	<ol style="list-style-type: none"> 1 After entering the password and accessing the "Technician" programming menu, rotate the Encoder Knob until the following is displayed.
	<ol style="list-style-type: none"> 2 Press the Encoder Knob to access the menu.
	<ol style="list-style-type: none"> 3 Press the Encoder Knob to reset the settings made in the "Barista" programming.
	<ol style="list-style-type: none"> 4 Press the Encoder Knob to reset the settings made in the "Technician" programming.

“Technical” Programming

Reset

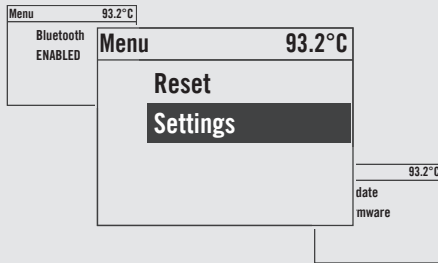

Description

- This parameter allows the technician to reset all the values returning to initial factory settings.
- It is possible to reset the settings you made in the “Barista” programming or the settings you made in the “Technical” programming.

Display	Operating Procedure
	<p>5 Press the Encoder Knob to quit the submenu.</p>
	<p>6 You must scroll to the exit menu to exit the programming mode, or press the Encoder Knob for 2 seconds.</p>

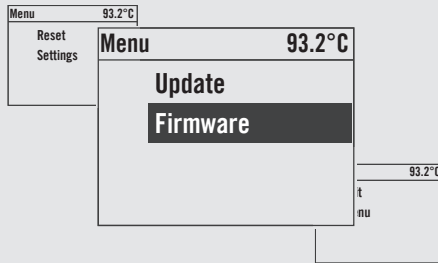

“Technical” Programming

Update Firmware

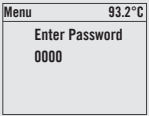
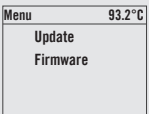
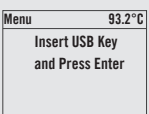

Description

- This parameter allows the technician to update the control unit of the espresso machine via a USB Pendrive.

Display	Operating Procedure
	<ol style="list-style-type: none"> 1 After entering the password and accessing the "Technician" programming menu, rotate the Encoder Knob until the following is displayed.
	<ol style="list-style-type: none"> 2 Press the Encoder Knob to access the menu.
	<ol style="list-style-type: none"> 3 Insert the USB Pendrive into the USB port and press the Encoder Knob.
	<ol style="list-style-type: none"> 4 When the update is over, the espresso machine restarts. Set the switch to 0 (zero) and then again to 1.

“Technical” Programming

Exit Menu

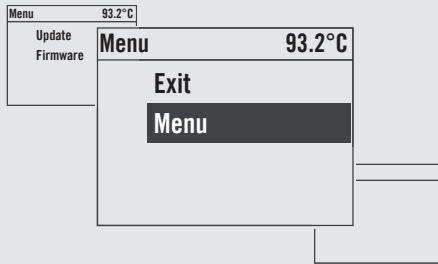

Description

- This parameter allows the technician to exit the “Technical” programming and return to the normal use of the espresso machine.

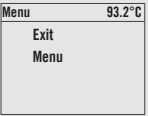
Display	Operating Procedure
	<ol style="list-style-type: none"> 1 Press the Encoder Knob to exit the “Technician” programming mode and return to the normal use of the espresso machine.

