

# GAGGIA

## MILANO



ENGLISH

# GAGGIA ACCADEMIA

RI9781 (SUP 052) RI9782 (SUP 052)

Operating instructions

CE

## Control panel

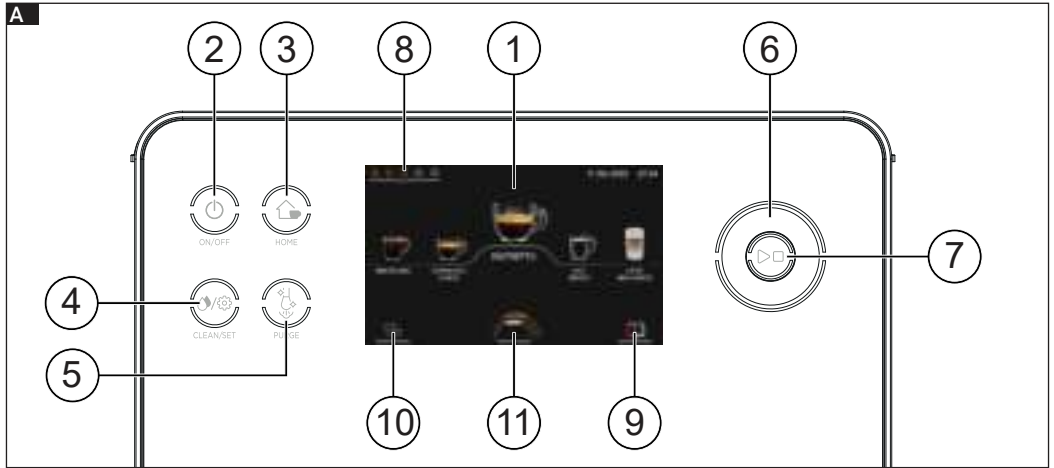

## Beverages menu



Ristretto



Melange



Frothed milk



Espresso



Cappuccino



Hot milk



Espresso lungo



Flat white



Green tea



Coffee



Café au lait



Black tea



Americano



Caffè latte



Hot water



Caffè Cortado



Cappuccino XL



Macchiato



Latte macchiato

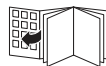

B

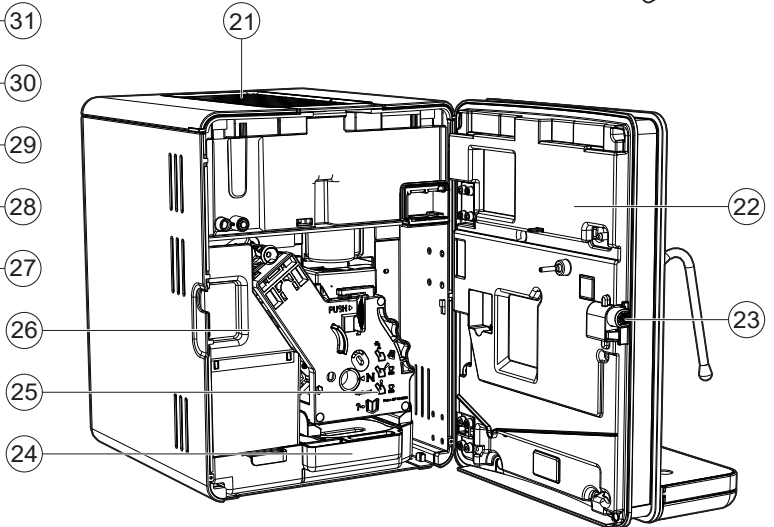
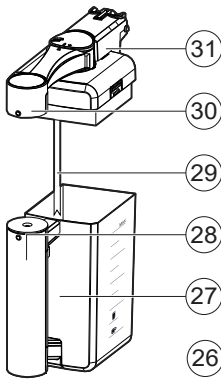
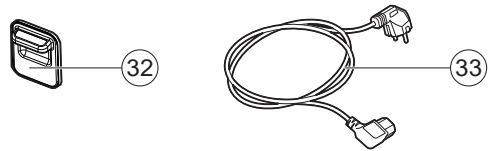
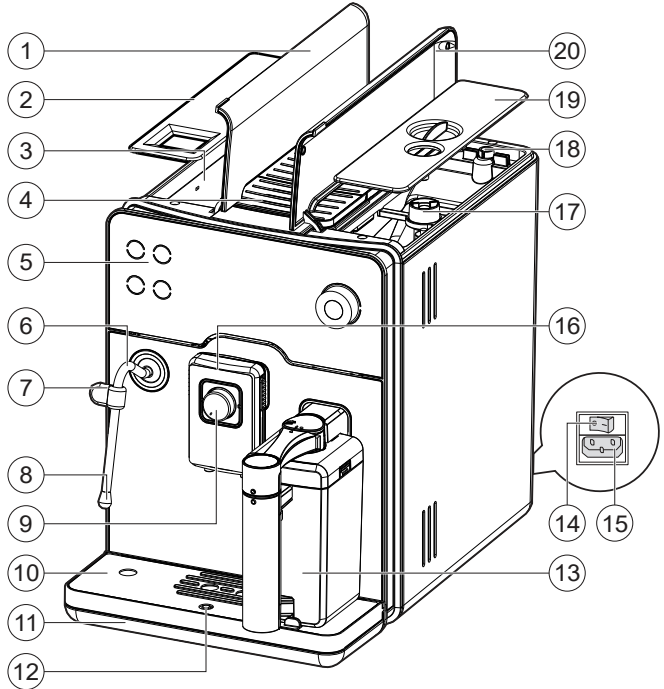
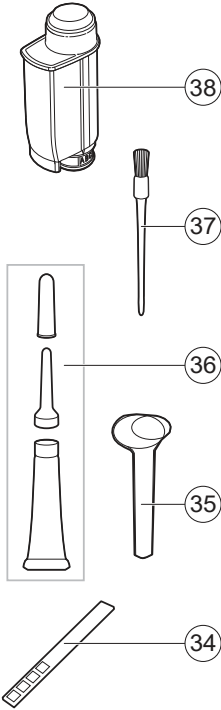

## Dishwasher safe components

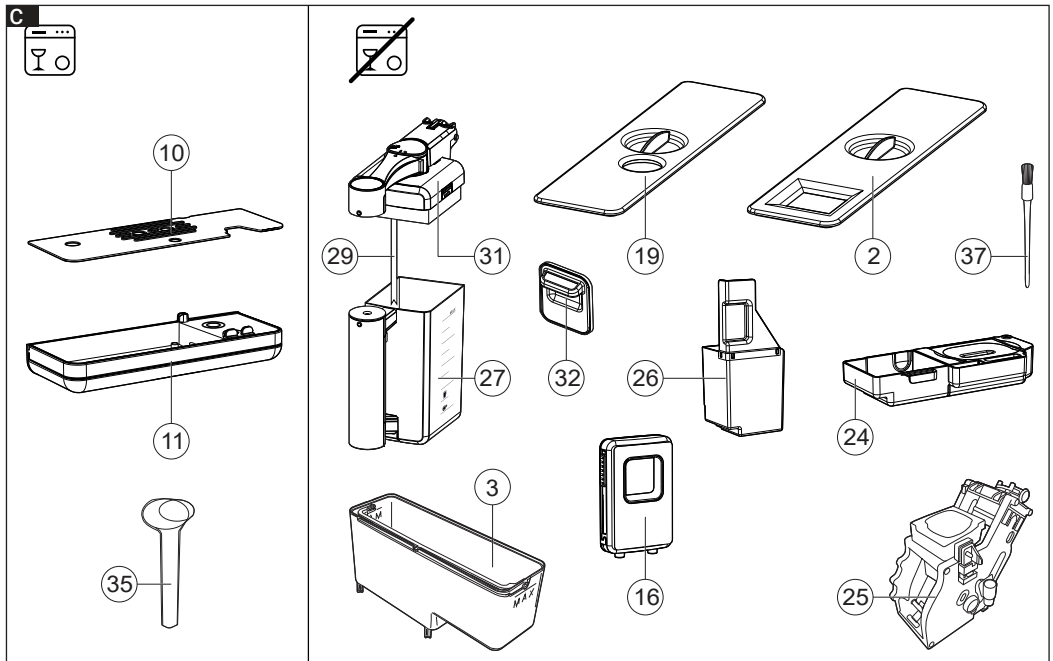

## Milk carafe disassembly

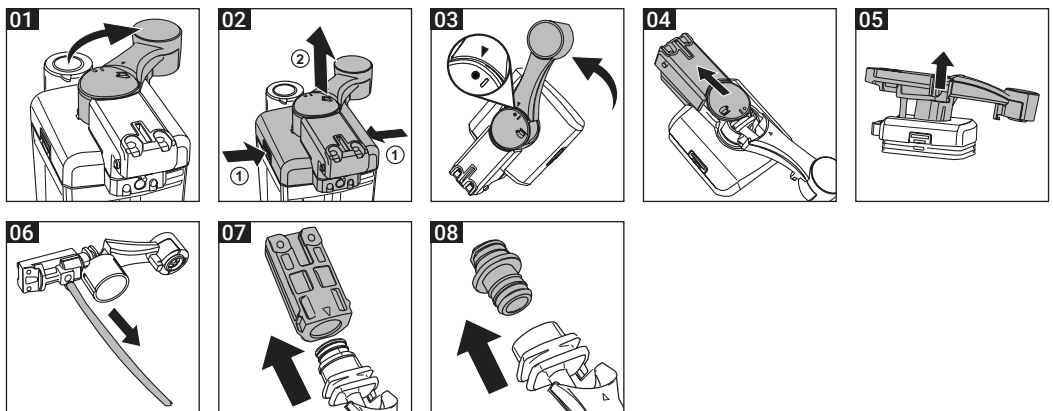

## ENGLISH

Congratulations on your purchase of Gaggia Accademia!

This easy-to-use machine guarantees excellent results every day.

Thanks to the intuitive interface, you can choose among 19 beverages, customise them and save them to the 4 available profiles, where they can be instantly brought up whenever you want.

Before being packed, each of our high-quality machines undergoes rigorous testing in our laboratories in order to ensure its correct operation. Some coffee residue might be found in your machine, since real coffee is normally used during testing. However, this does not compromise the integrity of the product. Please be assured that this is a brand new machine.

In this user manual you will find all the information you need to install, use, clean and descale your machine. Before using it for the first time, please read carefully the safety manual provided separately and store it for future use.

# Contents

---

<b>Machine overview (fig.B/C)</b>	<b>47</b>
<b>Control panel and display</b>	<b>48</b>
Control panel overview (fig. A)	48
Main display icons (fig. A)	48
Touch screen / knob operation	49
<b>Machine installation</b>	<b>49</b>
First use	49
Manual rinse cycle	50
Measuring the water hardness	51
INTENZA+ water filter	51
<b>Demo mode (if any)</b>	<b>53</b>
<b>Cup warmer</b>	<b>53</b>
<b>Beverage brewing</b>	<b>53</b>
Types of beverage	53
Adjusting the dispensing spout	55
How to use the carafe	55
"On the fly" function	57
Coffee brewing	57
Milk-based beverage brewing	59
Latte Art frothing using the steam wand	60
Tea brewing	61
Hot water brewing	61
<b>Espresso Plus System</b>	<b>62</b>
<b>Adjusting the grind settings</b>	<b>62</b>
<b>Beverage customisation</b>	<b>63</b>
Beverage settings support information	63
Beverage settings	64
<b>Profiles</b>	<b>66</b>
Choose a profile	66
Add or delete a beverage	67
MEMO function	67
<b>Machine settings</b>	<b>68</b>
<b>Cleaning and maintenance</b>	<b>71</b>
Cleaning table	71
Milk carafe cleaning	72
Cleaning the steam wand	73
Cleaning the brew group	74
Removing the brew group	74
Cleaning the brew group under fresh water	74
Cleaning the brew group with suitable pads to remove oily coffee residues	75
Reinserting the brew group	75
Lubricating the brew group	76
Descaling	77

<b>Error code key</b>	<b>79</b>
<b>Troubleshooting</b>	<b>80</b>
<b>GAGGIA accessories</b>	<b>83</b>
<b>Technical specifications</b>	<b>83</b>

## Machine overview (fig.B/C)

---







<b>1</b>	Water tank lid	<b>20</b>	Coffee bean container lid
<b>2</b>	Water tank inner lid	<b>21</b>	Cup warmer
<b>3</b>	Water tank	<b>22</b>	Service door
<b>4</b>	Pre-ground coffee compartment	<b>23</b>	Service door opening button
<b>5</b>	Control panel	<b>24</b>	Internal drip tray
<b>6</b>	Steam wand	<b>25</b>	Brew group
<b>7</b>	Steam wand handle	<b>26</b>	Coffee pucks container
<b>8</b>	Steam wand nozzle	<b>27</b>	Milk container
<b>9</b>	Espresso Plus System	<b>28</b>	Carafe handle
<b>10</b>	External drip tray grid	<b>29</b>	Milk suction hose
<b>11</b>	External drip tray	<b>30</b>	Carafe dispensing spout
<b>12</b>	Full drip tray indicator	<b>31</b>	Milk dispensing unit
<b>13</b>	Milk carafe	<b>32</b>	Carafe coupling cover
<b>14</b>	Power button	<b>33</b>	Power cord
<b>15</b>	Power cord socket	<b>34</b>	Water hardness measuring strip
<b>16</b>	Adjustable coffee dispensing spout	<b>35</b>	Pre-ground coffee measuring scoop
<b>17</b>	Coffee grinder adjustment knob	<b>36</b>	Lubricant
<b>18</b>	Coffee bean container	<b>37</b>	Cleaning brush
<b>19</b>	Aroma lid	<b>38</b>	Water filter





## Control panel and display

This coffee machine features an easy-to-use, intuitive display. Please see below for an in-depth explanation.

### Control panel overview (fig. A)

1	<b>Touch screen</b>	All functions of the machine can be selected via simple gestures such as touching or dragging the functions for navigation.
2	<b>ON/OFF  button</b>	To switch the machine on or off.
3	<b>HOME  button</b>	To get to the beverage menu or the start screen (if previously set).
4	<b>CLEAN/SET  button</b>	To get to the cleaning menu or machine settings.
5	<b>PURGE  button</b>	To start the cleaning or purging of the steam wand.
6	<b>Knob </b>	When active, it can be used instead of the touch screen to navigate among the display menus.
7	<b>START/STOP  button</b>	Starts or stops brewing the selected beverage or starts / stops the procedure indicated on the display.

**Note:** the HOME , CLEAN/SET  buttons have same functions as ESC buttons. You can exit any screen shown on the display at any time by pressing one of these buttons, which will then bring you back to their start menu.

### Main display icons (fig. A)

8	<b>Notifications</b>	These icons show the status of the machine. They can be opened for better understanding. By clicking on an open notification, you can directly access the setting, within the dedicated area.
9	<b>Instruction Manual</b>	By clicking on the icon you will find a QR code which, if scanned, will redirect you to web page with the digital Instruction Manuals.
10	<b>Profiles or Home</b>	By Clicking on the icon, a window opens to access the different profiles or the HOME screen.
11	<b>Espresso Plus System</b>	This icon gives you immediate and clear feedback on the coffee intensity and crema setting, by turning the knob on the coffee dispensing spout.

## Touch screen / knob operation

All display functions can be used via the touch screen. You can however operate some functions via the knob.

When the knob can be used, the LED lights around it will be steady on.

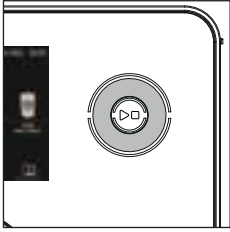

**Note:** in the instruction manual the  symbol will be used to indicate that both knob and touch screen can be used for that function.

**Note:** just click on  or on any other dark part of the screen to close a window.

## Machine installation

### First use

Before commissioning the machine, follow these few simple steps.

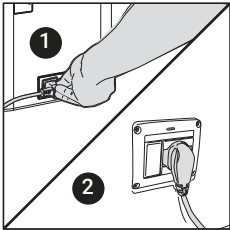
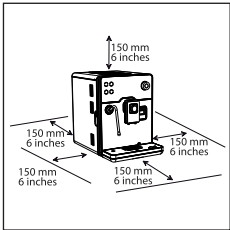

- 1 Fit one end of the power cord to the socket on the side of the machine. Insert the other end of the cord to a suitable power socket (see the data plate).

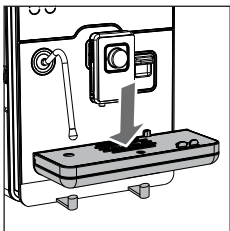

- 2 Insert the drip tray.

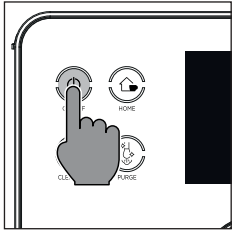

- 3 The historical Gaggia logo will be displayed. Then, the machine will go in stand-by mode. Press the **ON/OFF**  button to start the machine.

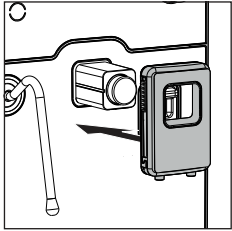

- 4 Insert the coffee dispensing spout as shown in the figure.
- 5 Follow the directions on the display, until the first installation is complete.

**Note:** to obtain a tastier coffee, we recommend that you initially prepare 5 cups of coffee for the machine to make a self-adjustment setting.



## Manual rinse cycle

During the first installation or after a long period of machine inactivity, a manual rinse cycle must be carried out.



- 1 Place a container under the coffee dispensing spout, scroll  the different beverages and click on ESPRESSO LUNGO, to enter the beverage settings.



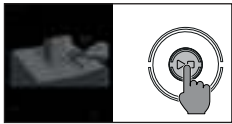

- 2 Once in the beverage settings, click on the AROMA icon, select , the  icon, but do not add pre-ground coffee.



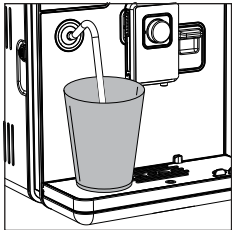



- 3 Press the **START/STOP**  button to start brewing. The machine will dispense hot water.







- 4 Empty and reposition the container under the steam wand and select  the HOT WATER beverage, by placing it on the pedestal.
- 5 Press the **START/STOP**  button to start brewing.
- 6 Empty the container and repeat steps 4 to 6 until the water tank gets empty.
- 7 When finished, refill the water tank up to the MAX level. The machine is now ready for use.

## Measuring the water hardness

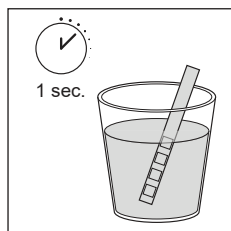
Upon machine commissioning, you will need to set the water hardness value. Take out the water hardness measuring strip from the machine box. Follow the steps shown on the display during installation phase. In case you want to change water hardness settings later, press the **CLEAN/SET**   button, then select **SETTINGS** , and once in the settings menu, scroll  and select **WATER HARDNESS**.

- 1 Immerse the water hardness measuring strip in a glass of water for one second. Remove the strip from the water and wait for one minute.
- 2 Check how many squares turn red.
- 3 Select the corresponding hardness value and confirm by pressing the .



Number of small red squares	Value to be set	Water hardness	INTENZA+
	1	very soft water	A
	2	soft water	A
	3	hard water	B
	4	very hard water	C

## INTENZA+ water filter

We recommend adding an INTENZA+ water filter, to limit limescale formation. This will ensure a longer lifetime of your coffee machine and a better coffee aroma over time.

Water represents an essential element for coffee brewing. Therefore, it is extremely important that water be always filtered in a professional way.

The INTENZA+ water filter prevents the formation of mineral deposits while improving the water quality.

## Installing the INTENZA+ water filter

Immerse the INTENZA+ water filter in cold water and in vertical position, with filter opening side upwards. Press both sides of the filter gently to let any air bubbles out.

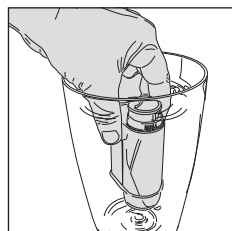

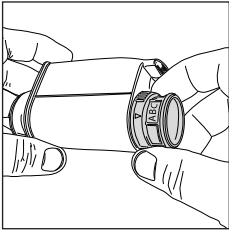







Remove the INTENZA+ water filter from water. Set the machine according to the measured water hardness (see the "Measuring water hardness" chapter) and the letters found on the filter base:

- A = soft water – 1 or 2 small squares
- B = hard water (standard) – 3 small squares
- C = very hard water – 4 small squares

Place the INTENZA+ filter in the water tank, taking care to position it correctly. Fill the water tank and place it in its compartment.

Press the **CLEAN/SET**   button, select **SETTINGS** , and once in the settings menu, scroll  and select **WATER FILTER**.





Follow the instructions shown on the display to activate the filter correctly.

**Note:** the filter activation procedure can be paused by pressing the **START/STOP**   button. Press the **START/STOP**   button again to resume the filter activation procedure.

## Replacing the INTENZA+ water filter

When the INTENZA+ water filter runs out, an alarm message will be displayed.



- 1 Replace or disable it by pressing the **CLEAN/SET**   button and then the **SETTINGS**  icon.
- 2 Scroll  and select the **WATER FILTER**.
- 3 Select **REPLACE** or **OFF** and confirm with the  icon.

Follow the instructions shown on the display to activate the filter correctly.



**Note:** If you are not replacing the filter, select **OFF** to disable the filter and its notifications.



## Demo mode (if any)

DEMO mode is a function that shows the main characteristics of the machine, disabling its normal operation. You can activate this function by clicking on the icon on the Gaggia Milano screen and exit at any time by clicking on the DEMO exit icon.



## Cup warmer

This function allows you to set the operation of the cup-warming surface located on the top of the machine.

Once turned on, the plate takes a few minutes to reach the operating temperature. This function can be activated by pressing the **CLEAN/SET**   button, selecting **SETTINGS** , and then **CUP WARMER AND TIMER**.

Once the cup warmer function is enabled, you can choose whether to activate a wake-up timer to wake up the machine and have the cup warmer on, at the pre set time.







**Note:** once a wake-up timer is activated, the machine stand-by automatically switches to 60 mins to allow the cup warmer to perfectly heat the cups. Then, it returns to the selected stand-by time.



















**Note:** At the preset time, the machine will wake up displaying the "Cupwarmer ON" icon. You just need to touch the screen to start the machine.



## Beverage brewing

### Types of beverage

Beverage name	Description
Ristretto  30 ml	A ristretto, served in a small cup, is an espresso whose brewing time is shorter than a regular espresso. As such, a ristretto is a shorter shot and lower in caffeine.
Espresso  40 ml	The espresso is known around the globe as true "Italian coffee". Served in a small cup, its unmistakable characteristics are a full and intense aroma and a top layer of compact, natural crema. It is the result of the hot-water pressurised extraction process invented by Achille Gaggia in 1938.
Espresso lungo  80 ml	An espresso lungo is an espresso shot with a longer extraction time. It is more diluted, with a different aromatic intensity and a higher caffeine content. It is served in a medium-sized cup
Coffee  120 ml	Coffee is a beverage prepared with a greater quantity of water than an espresso shot. It has a lighter aroma and is served in a medium-large cup.
Americano  40 ml  110 ml	An Americano is a long, less intense coffee drink prepared by combining hot water and espresso.

Cortado	 40 ml  30 ml	The cortado is an Argentinian beverage, consisting of an espresso shot with a small quantity of milk. It is usually served in a small glass and is popular in Spain, Portugal, and Latin America.
Macchiato	 40 ml  40 ml	Macchiato is born in Venice. It consists of espresso coffee, milk and milk foam in smaller quantities than cappuccino. It is served in a large cup.
Melange	 70 ml  70 ml	Melange is a Viennese beverage consisting of one part coffee and one part milk with foam. It is similar to cappuccino but lighter.
Cappuccino	 40 ml  120 ml	The cappuccino is an Italian classic, among the most loved in the world. It is prepared with espresso, milk and a milk froth, which must be no less than 1 cm thick. It is served in a large cup.
Flat white	 40x2 ml  80 ml	A flat white is a beverage of Australian origin which has a strong, dominant coffee flavour. It is composed of a double espresso and milk, topped with a light layer of velvety foam.
Café au lait	 90 ml  90 ml	A café au lait is a beverage composed of equal parts coffee and milk. This can even be enriched by a thin layer of milk froth. It is served in a large cup.
Caffèlatte	 60 ml  140 ml	The Caffèlatte is a beverage that is mainly drunk at breakfast and consists of espresso coffee and a good quantity of hot, not foamed milk. It is served in a large cup or glass.
Cappuccino XL	 70 ml  180 ml	An XL cappuccino is a cappuccino prepared with a greater quantity of espresso and milk.
Latte macchiato	 40 ml  240 ml	A latte macchiato is prepared with hot milk, one part milk froth and a small quantity of espresso. It is served in a tall, transparent glass to allow the separation of the three different layers to be seen.
Frothed milk	 180 ml	Frothed milk is used to make cappuccinos, latte macchiatos and several other beverages. The result is a compact, homogeneous layer of milk froth.
Hot milk	 180 ml	Hot milk can be tasted on its own, adding aromas or used in the preparation of many other beverages, such as milk and coffee or hot chocolate.
Green tea	 150 ml	Green tea is an age-old beverage with antioxidant properties, against tiredness and fatigue. The beverage is obtained by brewing leaves in hot water at about 80°C (175°F).
Black tea	 150 ml	Black tea is characterised by a very intense taste and is often drunk with lemon or milk. It is obtained by brewing leaves in hot water at about 90° C (195° F).
Hot water	 150 ml	Hot water can be used to prepare hot teas, infusions and instant beverages.

## Adjusting the coffee dispensing spout

The coffee dispensing spout can be adjusted depending on the cup used. If you wish to try a traditional Italian espresso with a delicious layer of natural crema on top, we suggest you to set the dispensing spout height close enough to the cup.

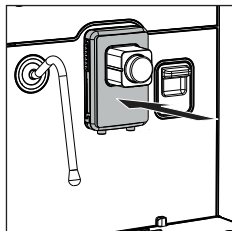
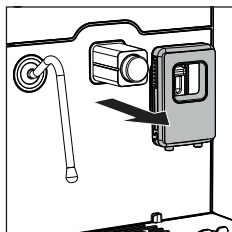
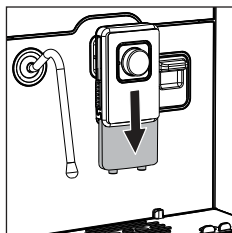

If you wish to prepare beverages that require the use of tall or large glasses or cups, you can remove the coffee dispensing spout or move it backwards.

## How to use the carafe

**Note:** Before using the milk carafe, clean it thoroughly as described at the “Milk carafe cleaning” chapter.

- 1 Turn the carafe dispensing spout clockwise.

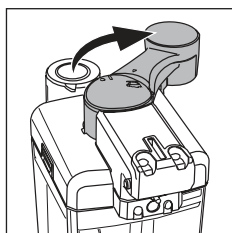



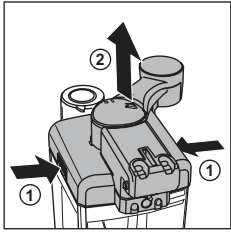

- 2 Press the release buttons to remove the lid.

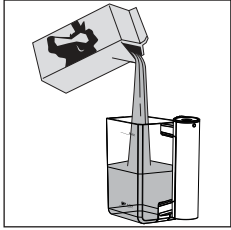

- 3 Pour the milk into the carafe. The milk level must be between the minimum (MIN) and the maximum (MAX) sign on the carafe. Place the lid back making sure that the carafe dispensing spout is in central position to ensure a perfect dosing.

## Inserting the milk carafe

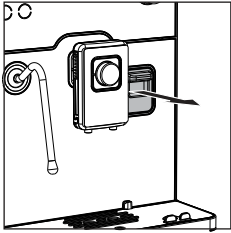

- 1 Remove the carafe coupling cover, if installed.

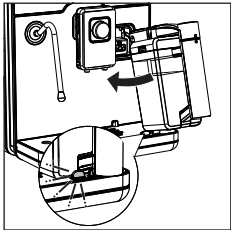

- 2 Tilt the carafe slightly and insert it all the way into the guides of the machine, until it hooks onto the external drip tray.

**Note:** do not force the carafe into position.

## Removing the milk carafe

Rotate the carafe upwards until it naturally unlocks from its housing in the drip tray. Then remove it.

## "On the fly" function

The "ON THE FLY" function allows you to change beverage quantities in real time, while brewing.

- 1 By moving the slider showing the preset level to reach while brewing, you can change the amount to be dispensed.

**Note:** as you move the slider, the preset level will be indicated by a white dot.

- 2 Once you have changed the quantity, confirm it with the ✓ icon.

**Note:** until you confirm with the ✓ icon, the change will not take place.

**Note:** if the coffee boost is activated, quantity cannot be changed after the second grinding.

**Note:** if the quantity of a milk-based beverage is changed, the preset milk foam level may change accordingly.

## Coffee brewing

### Coffee beans

**Warning:** use only coffee beans that are suitable for espresso brewing. Do not put any ground, unroasted, freeze-dried, or instant coffee in the coffee bean container, as they may damage the machine.

**Tip:** preheat the cups on the cup warmer to enjoy a hotter coffee.

- 1 Place a cup under the coffee dispensing spout, then raise, lower or remove the coffee spout according to the size of the cup being used.

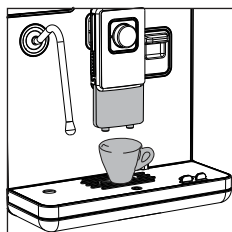



- 2 Scroll  the different beverages to find and select the desired coffee, by placing it on the pedestal.





- Once the desired beverage has been placed on the pedestal, press the **START/STOP**  button to start brewing.

**Note:** you can also dispense by clicking on the desired beverage icon without placing it on the pedestal, then pressing the **START/STOP**  button.

**Note:** you can interrupt the brewing at any time by pressing the **START/STOP**  button or change the quantity using the "ON THE FLY" function.

If you wish to customise the settings of a specific beverage, please refer to the "Beverage customisation" chapter.

## Pre-ground coffee

Use the measuring scoop supplied to put the correct dose in the pre-ground coffee compartment.

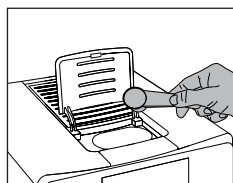

- Lift the lid of the pre-ground coffee compartment and add a level measuring scoop of pre-ground coffee.

**Warning:** do not insert any other product than the pre-ground coffee, as the machine could get damaged.

- Place a cup under the coffee dispensing spout and select the desired beverage by clicking on the beverage icon.
- Once in the beverage settings, click on the AROMA icon.
- Press  icon or select it using the knob.

**Note:** The "pre-ground coffee" excludes the possibility of brewing two cups of coffee at the same time.

**Note:** this function is not available for FLAT WHITE.

- Press the **START/STOP**  button to start brewing coffee.

**Note:** you can stop brewing at any time by pressing **START/STOP**  button or change the quantity by using the "ON THE FLY" function.



If you wish to customise the settings of a specific beverage, please refer to the "Beverage customisation" chapter.



## Milk-based beverage brewing

**Tip:** to enjoy a hotter beverage, preheat the cups by putting them onto the cup warmer.

**Tip:** to ensure a perfect result, we recommend using cold whole milk (at abt. 5°C) with a protein content of at least 3% and a fat content of at least 3.5%. The proteins will make the air be incorporated into the foam, while the fats will make it thick and firm. Good results can also be obtained using semi-skimmed cow's milk, some types of lactose-free milk, soy, almond as well as with oat beverages.

- 1 Press the **HOME**  button and select your beverage  from the menu, by placing it on the pedestal.
  - Place a suitable cup or glass beneath the coffee dispensing spout and carafe dispensing spout.
  - Press the **START/STOP**  button to start brewing the selected beverage.

**Note:** you can also dispense by clicking on the desired beverage icon without placing it on the pedestal, then pressing the **START/STOP**  button.

- 2 The machine brews a default amount of coffee and milk into the cup or the glass. Depending on the beverage chosen, either coffee or milk will be brewed first.

**Note:** you can interrupt the brewing at any time by pressing the **START/STOP**  button or change the quantity using the "ON THE FLY" function.

If you wish to customise the beverage before brewing, refer to the "Beverage customisation" chapter.

- 3 Immediately after the milk is brewed, the machine emits a short steam shot to keep the system running efficiently.
- 4 Close the carafe dispensing spout to sanitize the milk circuit with steam. You do not need to remove the milk from the carafe.

**Warning:** the carafe dispensing spout is to be tightly closed and aligned with the handle to prevent water/steam splashing or puffing.

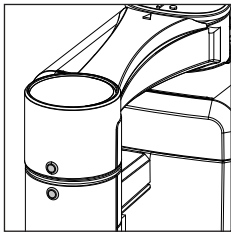
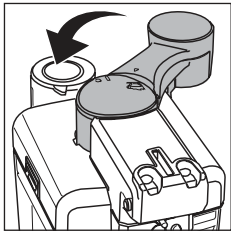
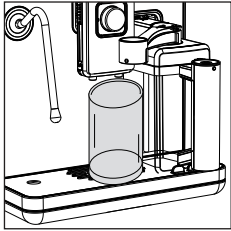

The machine allows you to run a quick cleaning cycle whenever you wish, by entering the relevant menu. Please refer to the "Carafe cleaning" chapter.



## Latte Art frothing using the steam wand

With the steam wand and a little practice, you can obtain a sweet and creamy micro-foam that is ideal for a perfect Latte Art.

**Tip:** before proceeding with the milk foaming, purge the steam wand for a few seconds by pressing the **PURGE**  button to eliminate any possible condensation.

- 1 Fill a jug with cold milk of about 1/3 full.
- 2 Insert the nozzle of the wand just below the surface of the milk; if too deep into the milk, milk foam will not be produced; if too outside milk surface, large bubbles will be produced getting immediately runny.
- 3 Keep the nozzle not in the middle, but close to the edge of the jug, thus creating an inclination suitable to produce a stronger swirl.
- 4 Press **HOME**  button to access the beverage menu. Select **STEAM**, then press the **START/STOP**  button to start foaming the milk.
- 5 For proper milk foaming, keep the steam nozzle in contact with the milk and not with milk foam. Then, as the foam layer increases, slightly raise the jug keeping the nozzle in contact with the milk and without touching the bottom of the jug.  
Once the desired frothing has been achieved, push the steam wand deeper into the milk to heat it completely.
- 6 When the milk foam reaches the desired consistency. Press the **START/STOP**  button to stop steam dispensing. Wait until the steam dispensing has stopped completely, before removing the jug.

**Note:** always keep one hand onto the rounded part of the jug to feel the temperature increase on the milk portion not foamed.

**Note:** gently beat the jug onto the table to get milk foam more compact. Leave it rest for at least 30 secs. The milk becomes more homogeneous.

- 7 After foaming the milk, clean the steam wand via the **PURGE**  button.

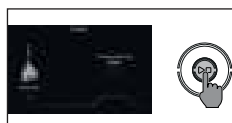
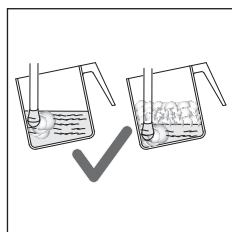
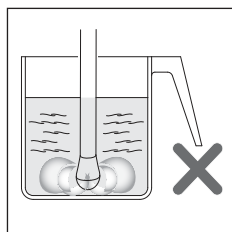
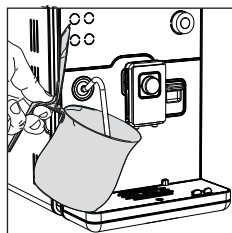



## Tea brewing

**Warning:** when brewing starts, the steam wand may spray steam and hot water jets.

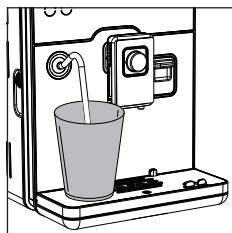
- 1 Put some loose tea into a tea strainer or put directly a tea bag into a cup.
- 2 Place the cup under the steam wand.



- 3 Press the **HOME**  button, scroll  and select your TEA by placing it on the pedestal.
- 4 Press **START/STOP**  button to start hot water brewing.

Hot water temperature for brewing depends on the type of tea chosen. You need approximately 80°C for GREEN TEA and 90°C for BLACK TEA brewing.

**Note:** you can also dispense by clicking on the desired tea icon without placing it on the pedestal, then pressing the **START/STOP**  button.

**Note:** you can interrupt the brewing at any time by pressing the **START/STOP**  button or change the quantity using the "ON THE FLY" function.

If you wish to customise the water quantity before brewing, refer to the "Beverage customisation" chapter.

**Tip:** refer also to the tea package instructions for a perfect tea brewing.

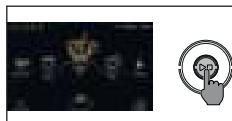

## Hot water brewing

**Warning:** when brewing starts, the steam wand may spray steam and hot water jets.

- 1 Place a container under the steam wand.

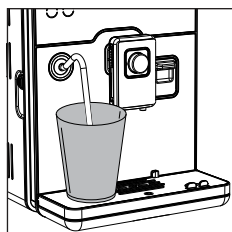

- 2 Press the **HOME**  button, scroll  the various beverages, then select HOT WATER.



- 3 Once you have placed the beverage on the pedestal, press the **START/STOP**  button to start brewing.

**Note:** you can interrupt the brewing at any time by pressing the **START/STOP**  button or change the quantity using the "ON THE FLY" function.

If you wish to customise the water quantity before brewing, refer to the "Beverage customisation" chapter.

## Espresso Plus System

The Espresso Plus System function has been expressly designed to give the coffee the desired body and taste intensity. You can choose from a rich crema with an intense flavour to a more delicate and lighter taste.

Just turn the knob and set the coffee intensity from mild to strong, according to your taste.

The adjustment can also be made while the coffee is brewing. It will take immediate effect on the selected brew.

By turning the knob the active Espresso Plus System area will be displayed. By clicking directly on the Espresso Plus System icon you can view the 3 different areas:

- Full body, thick crema;
- Regular body and crema;
- Lighter body, thinner crema.

## Adjusting the grind settings

The grind settings can be adjusted via the knob located on the coffee bean container.

**Note:** the grind setting can only be adjusted while the machine is grinding the coffee beans. The difference in taste will be perceived after 2-3 coffee brewings.

**Warning:** to avoid damages to the coffee grinder, do not rotate the grinder adjustment knob by more than one notch at a time.

- 1 Place a cup under the coffee dispensing spout.
- 2 Open the lid of the coffee bean container.
- 3 Prepare an espresso as described in chapter "Brewing coffee using coffee beans".

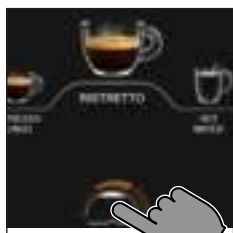
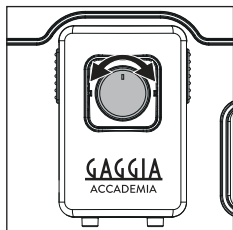

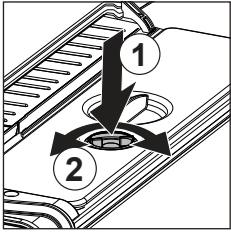

- 4 Adjust the coffee grinding with the machine in operation, by pressing and turning the knob left- or rightwards of one notch at a time.

- 5 You can select from 8 different grinding settings. The smaller the notch value, the stronger and richer the coffee.

**Note:**

- Coarse grind: lighter taste, suitable for dark roasted coffee blends (4-8);
- Fine grind: stronger taste, for light roasted coffee blends (1-4);

## Beverage customisation

This machine allows you to modify the settings of a beverage according to your preferences, thus saving the modified beverage among one of the 4 profiles available.

## Beverage settings support information

When you enter the settings of a drink, by clicking on the ⓘ icon at the top right, you will find a brief explanation of the parameters that can be modified and how they can affect the final result in the cup.



After entering this function, you can use the ◀ and ▶ icons to display the different explanations. Or click on the ✕ icon to close the support function.







## Beverage settings

Press **HOME**  button and select your beverage, by clicking on it.



All the settings that can be adjusted and/or selected are displayed on the screen. Based on the type of beverage you want, you can adjust and/or select:

- coffee, milk and/or water quantities;
- aroma intensity (only when using coffee beans);
- coffee boost function;
- use of pre-ground coffee;
- pre-brewing function;
- milk foam quantity;
- brewing two cups at a time;
- coffee temperature;
- beverage renaming;
- save function;

## Beverage quantity

Once you click on the **COFFEE** , **MILK**  or **WATER**  icons, move the slider on the touch screen or use the knob to set the desired quantity. Exit the function by clicking on the **X** icon or on the dark part of the screen to pass to another setting.

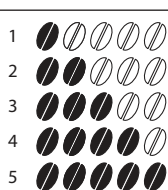

## Aroma function

Click on the relevant  icon to change the intensity of the aroma. A window will open, click on the  icon several times or use the knob until the desired aroma is selected. Each time you click the icon, the aroma intensity changes by one degree at a time:





- 1 Very light
- 2 Mild
- 3 Normal
- 4 Strong
- 5 Very strong

## Coffee boost

Click on the  icon to open the function, select the  icon by clicking it or using the knob. The machine will perform a double grinding to make the coffee taste more intense. It can be used for a coffee quantity greater than or equal to 50 ml.

**Note:** if you set the coffee boost with a beverage quantity of less than 50 ml, it will automatically be increased to 50 ml. If the beverage quantity is set below 50ml, coffee boost is deselected and aroma will automatically be set to maximum intensity.

## Pre-ground coffee





Click on  icon to open the function, select  icon to activate the pre-ground coffee.

**Note:** this function only allows brewing one coffee at a time.



## Pre-brewing

A longer or shorter pre-brewing can enhance the taste of coffee, depending on the type of coffee blend used.

Click on the PRE-BREWING  icon several times to select a pre-brewing time:

-  Pre-brewing disabled;
-  Short pre-brewing;
-  Medium pre-brewing;
-  Long pre-brewing;

## Two cups

Click on the  icon to brew two cups, or the  icon to prepare only one cup. The beverage picture in the middle of the display will indicate the number of cups selected.

**Note:** the TWO CUPS  function is only available for some kind of beverages.

## Milk foam

Click on the  icon and select the desired quantity of foam. You can select 4 levels, from hot milk with a thin layer of foam to a richer and homogeneous milk foam layer:

- hot milk, with a thin layer of foam;
- low foam layer;
- medium foam layer;
- rich foam layer.

## Temperature

Click on the TEMPERATURE  icon several times to change the temperature of the beverage from the following options:

- low;
- medium;
- high;





## Renaming the beverage

By clicking on the  icon you can change the name of the beverage and then save it in your profile. The same beverage can be saved several times in the same profile (Ex: espresso A, espresso B, strong espresso, etc).

The keyboard has multiple screens to enable special characters input. Click on the  icon on the keypad to change screen.

## Saving in a profile



- 1 Once you have customised the beverage according to your tastes, you can save it in a profile by clicking on the  icon.
- 2 Choose the profile in which you want to save the beverage from among 4 available ones.
- 3 If you have already saved other beverages in your profile, you can choose where to enter it. Scroll the list of beverages using the touch screen or the knob, place the beverage on the pedestal in the preferred position and press the  icon to confirm.

**Note** : if you do not wish to save the beverage, simply click on the  icon.

## Profiles

The machine allows you to change the settings of a beverage and rename it according to your preferences, by saving it in one of the 4 available profiles.

### Choose a profile

- 1 Click  icon.
- 2 Select your preferred profile colour.  
The profile will be empty if no beverage has yet been entered and the selection pedestal will be of the same colour as the chosen profile.
- 3 To return to the HOME screen, click the  icon and select  icon.



## Add or delete a beverage

1 Press **+** icon.



2 The beverage list will be displayed. Scroll beverages **○** and select the one you want to save in your profile. If you want to customise it, go to the "Beverage settings" chapter.

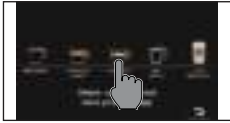





3 Click on the **♥✓** icon to save the beverage. If you have already saved other beverages in your profile, you can choose where to enter it. Scroll **○** the list of beverages, place the beverage on the pedestal in the preferred position and press **✓** icon to confirm.



**Note** : if you do not wish to save the beverage, simply click on the **✕** icon.

4 The beverage is added in your profile and is now ready to be brewed via the **START/STOP ▷□** button.



**Note**: to exit use **HOME** , **CLEAN/SET**  buttons, or click on  icon and select  icon.

**Note**: Once used, the profile  icon will be fully coloured.

5 The beverage saved in your profile can be modified and saved by overwriting the settings or deleted using  icon once it has been placed on the pedestal. You will be asked to confirm deletion twice.





## MEMO function

If you dispense a beverage from the profiles and change the quantity while dispensing by means of the "ON THE FLY" function, you can save the new setting by overwriting the previous one. At the end of the dispensing, you will be asked if you want to save the setting.



**Note**: the machine does not require saving if dispensing is stopped using the **START/STOP ▷□** button.

## Machine settings

By pressing the **CLEAN/SET**   button and **SETTINGS**  icon on the display, you can reset or modify some machine parameters such as:

- Language
- Date and time
- Unit of measurement
- Button sound
- Start screen
- Cup warmer and timer
- Eco mode
- Reset to factory settings
- Beverage counter
- Water hardness
- Water filter
- Stand-by timer

## Language

Select **LANGUAGES**, scroll  the list of available languages, select and confirm the required language:

### Lingue disponibili

ITALIAN	DANISH	CZECH
ENGLISH	GREEK	SLOVAK
GERMAN	POLISH	LITHUANIAN
FRENCH	RUSSIAN	JAPANESE
SPANISH	ROMANIAN	KOREAN
PORTUGUESE	HUNGARIAN	CHINESE TRADITIONAL
DUTCH	BULGARIAN	CHINESE SIMPLIFIED

## Date and time

- 1 Once the **DATE AND TIME** function has been selected, you can change them by scrolling day, month and year using the touch screen or by clicking on one of the items and selecting the value via the knob.
- 2 Confirm by clicking on the  icon to go to the next screen which allows you to set the time by following the same logic described for the date.



## Units

---



By selecting UNITS:

you can set the measurement units to "ml" or "oz".

## Button sound

---



By selecting the BUTTON SOUND:

you can turn the button sound on or off.

## Start Screen

---



By selecting START SCREEN:

you can set your profile as your startup screen.

After pressing on START SCREEN, select and confirm with  icon the desired profile.

Whenever the machine turns on or when you press the **HOME**  button, the profile set will be displayed.

## Cup warmer and timer

---



By selecting CUP WARMER AND TIMER:

you can enable or disable the cup warmer.



Once the cup warmer has been activated, you can set a machine wake-up timer by clicking on ON.



You can enable up to 3 timers by clicking on timer and setting the time and days of the week you want.

Once confirmed, via the  icon, these will be updated within the timer. A green square indicates when the timer is active.

The timer can be enabled or disabled by clicking on this square.



Confirm all settings before exiting the function by clicking on the  icon.



## Eco mode

---

The ECO MODE function enables energy saving. If activated, the machine sets automatically as follows:

- Cup warmer is OFF;
- Buttons lighting is OFF;
- Button sound is OFF;
- Stand-by time is set to 15 mins;
- Screen brightness (if not touched) is low.

## Reset to factory settings

---

The machine can be set back to the factory setting. The machine will ask you for a double confirmation before proceeding. All parameters will be reset except those relating to profiles (**MY FAVOURITES**) and the beverage counter.



## Beverage counter

---

The number of cups for each chosen beverage can be displayed from the first brewing onwards. These data cannot be reset.



## Water hardness

---

Select WATER HARDNESS. You can set and adapt the water hardness in use in your home. Find out the correct values to set as per the instructions given in the "Measuring water hardness" chapter.



## Water filter

---

Once the WATER FILTER has been selected, follow the instructions on the display and in chapter "Installing the INTENZA+ water filter" and in "Replacing the INTENZA+ water filter".



## Stand-by timer

---

After selecting the STAND-BY TIMER, set the timer by scrolling on the touch screen or via the knob.



## Cleaning and maintenance

Regular cleaning and maintenance keep the machine in top condition and ensure consistently great coffee, constant brewing flow, and an excellent milk foam. Refer to the following table to know when and how removable parts of the machine need to be cleaned. For further details, refer to the relevant chapters.

### Cleaning table

Part description	When to clean	How to clean
Milk carafe.	After use.	After every milk-based brewing, when you close the carafe dispensing spout the machine will sanitize the milk circuit with steam. If this does not start immediately after brewing, it will however start once the carafe dispensing spout be closed. You can carry out a further quick cleaning whenever you want via the QUICK CLEAN function, in the relevant area.
	Weekly.	Disassemble the milk carafe and clean all parts under fresh water.
	Monthly.	Start the DEEP CLEAN cycle by following the instructions described in the "Milk carafe deep clean" chapter. For this milk circuit cleaning cycle, use the Philips product "Milk circuit cleaner".
Steam wand.	After use.	Clean the steam wand externally with a damp cloth and internally using the <b>PURGE</b>  button.
Brew group.	Weekly.	Remove the brew group and clean it under fresh water.
	Depending on usage.	See chapter "Cleaning and lubricating the brew group".
	Monthly.	Clean the brew group with the Gaggia coffee oil remover to remove any oily coffee residue.
Full external drip tray.	When the red indicator comes out from the grid.	Empty the drip tray and clean it under running water.
Full internal drip tray.	Whenever the machine requires it.	Empty the drip tray and clean it under fresh water. This operation must be performed when the machine is ON.
Coffee pucks container	Whenever the machine requires it	Empty the coffee pucks container and wash it under fresh water. Make sure that the machine is switched on during this operation; otherwise the coffee grounds container will not reset.
Water tank	Weekly	Clean under fresh water.



Part description	When to clean	How to clean
Pre-ground coffee compartment/coffee outlet duct	Weekly	Clean the upper part using the handle of a spoon, as shown below.

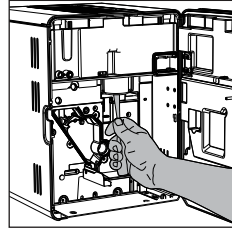



## Milk carafe cleaning

### Steam hygiene

By closing the carafe dispensing spout, the machine automatically sanitises. The milk can be kept inside the carafe.





### Quick clean

The quick clean programme includes the cleaning of the milk dispensing spout. The cleaning procedure can be carried out with milk in the carafe. This cycle is selected by means of the **CLEAN/SET**   button. Select **CLEANING**  icon, click on **QUICK CLEAN** and follow the instructions on the display.



### Deep clean

The carafe deep clean cycle provides an intensive cleaning of the entire milk circuit using the Philips "Milk circuit cleaner" product. This cycle is selected by means of the **CLEAN/SET**   button. Select the **CLEANING**  icon, then click on **DEEP CLEAN** and follow the instructions on the display.



## Cleaning the carafe parts under fresh water

The milk carafe should be cleaned after disassembling all parts and be washed under fresh water, by following the steps below.

- 1 Turn the carafe dispensing spout clockwise up to the ☕ symbol (fig. 01).
- 2 Press the release buttons to remove the lid (fig. 02).
- 3 Turn the carafe dispensing spout anticlockwise up to the symbol ● (fig. 03).
- 4 Remove the connector to be inserted into the machine (fig. 04).
- 5 Remove the carafe dispensing spout (fig. 05).
- 6 Remove the milk suction hose (fig. 06).
- 7 Remove the external support by pulling it (fig. 07).
- 8 Remove the internal support (fig. 08).
- 9 Clean all parts with warm water.
- 10 Reassemble all the parts in reverse order.

## Cleaning the steam wand

After each milk frothing:

- 1 Clean the steam wand with a damp cloth. For a deep cleaning unscrew the nozzle and wash it with running water.
- 2 Press the **PURGE**  button and blow out the steam to clean the wand of any milk residue.

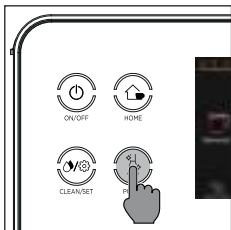
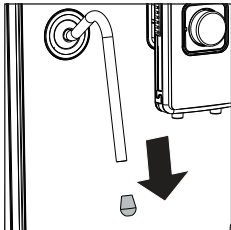

## Cleaning the brew group

**Warning:** never put the brew group in the dishwasher and never use dishwashing detergents, since these can damage the brew group and alter the coffee taste.

### Removing the brew group

- 1 Turn off the machine and disconnect the power cord.
- 2 Press the button on the left side of the machine and open the service door.

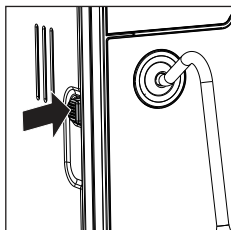

- 3 Remove the internal drip tray and the coffee pucks container.

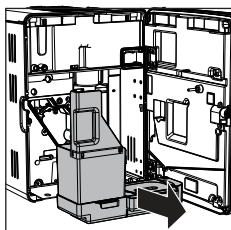

- 4 Press the PUSH lever (1) and pull the handle of the brew group (2) to remove it from the machine.

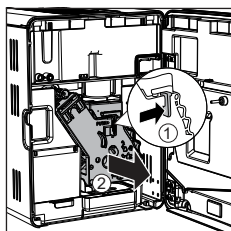

### Cleaning the brew group under fresh water

- 1 Clean the coffee outlet duct thoroughly with a teaspoon handle or with another round-tipped kitchen utensil.

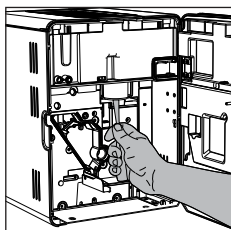

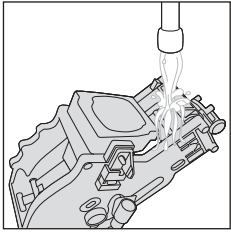

- 2 Thoroughly rinse the brew group using lukewarm water. Carefully wash the upper filter.
- 3 Let the brew group dry in the air.





**Note:** do not dry the brew group using cloths to prevent that any fibres penetrate inside.

## Cleaning the brew group with coffee cleaning tablets –

**Warning:** use only Gaggia tablets for removing oily coffee residue.



- 1 Place a container under the coffee dispensing spout.

- 2 Press the **CLEAN/SET**  button and select the **CLEANING**  icon shown on the display.
- 3 Select **BREW GROUP CLEANING** and press the **START/STOP**  button to start the cleaning procedure.
- 4 Follow the instructions shown on the display to clean the brew group correctly.
- 5 The procedure will take approximately 5 minutes. The **START/STOP**  button can be used to pause and resume the procedure.



## Reinserting the brew group

- 1 Before reinserting the brew group into the machine, make sure that the two yellow reference marks on the side match. If this is not the case, perform the following step:

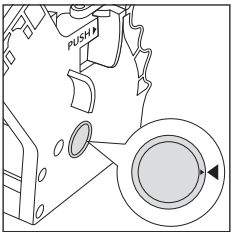

Make sure that the lever is in contact with the base of the brew group.

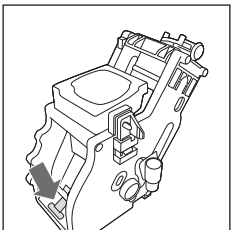

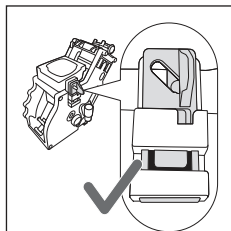

- 2 Make sure that the yellow locking hook of the brew group is in the correct position.

To position the hook correctly, push it upwards to the highest possible position.

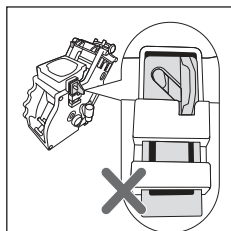

If the hook is still in a lower position, this means that it has not been correctly positioned.

- 3 Reinsert the brew group into the machine along the side guides until it locks in position with a click.

**Warning:** do not press the PUSH lever.

- 4 Insert the internal drip tray and the coffee pucks container.
- 5 Close the service door.

## Lubricating the brew group

To ensure the perfect performance of the machine, it is necessary to lubricate the brew group. Refer to the following table for the frequency of lubrication.

Frequency of use	Number of daily brewed beverages	Lubrication frequency
Low	1-5	Every 4 months
Regular	6-10	Every 2 months
High	>10	Monthly

- 1 Turn off the appliance and unplug the power cord.
- 2 Remove the brew group and rinse it with lukewarm water (see chapter "Brew group cleaning under fresh water").
- 3 Apply a thin layer of the supplied lubricant around the insertion pin located at the bottom of the brew group.

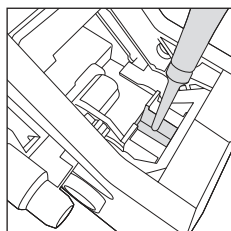

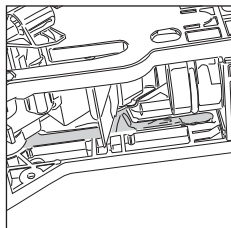

- 4 Apply a thin layer of lubricant to the guides on both sides (see figure).
- 5 Reinsert the brew group (see the "Reinserting the brew group" chapter).

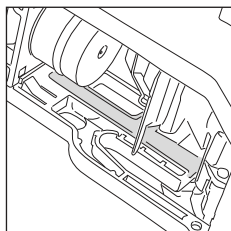

**Note:** the lubricant tube can be used numerous times.



## Descaling

### Descaling procedure

Descaling should be done whenever necessary.

Use only the Gaggia descaling solution designed to guarantee high quality performance of the machine. The use of different products could damage the machine and leave residues in the water. Failure to descale the machine will void the warranty.





- 1 Press the **CLEAN/SET**  button and select the **CLEANING**  icon, on the display. Otherwise, you can use the notifications to access .
  - Press the **DESCALING** icon and then press the **START/STOP**  button.

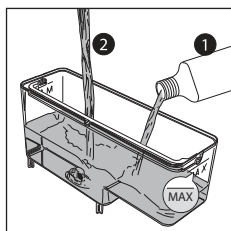

- 2 Remove the internal drip tray and the coffee pucks container, empty them and insert them back into the machine.
- 3 Turn the Espresso Plus System knob anticlockwise up to the limit stop.
- 4 Remove the water tank and empty it. Remove the INTENZA+ filter, if present.
- 5 Pour the entire bottle of the Gaggia descaling solution into the water tank. Fill it with water up to the **MAX** level and put it back into the machine body.



- 6 Fill the milk carafe halfway with water and insert it into the machine.
- 7 Follow the instructions shown on the display to launch the descaling procedure. This procedure takes about 25 minutes and consists of a descaling cycle and a rinse cycle, performed with dispensing at regular intervals.
- 8 Once the descaling cycle has finished, rinse the water tank, the carafe and the water circuit as per the displayed instructions.
- 9 Put back the INTENZA+ filter into the water tank.

**Note:** You can pause and resume the procedure at any time by pressing the **START/STOP**   button.

**Warning:** when the descaling cycle is running, the brew group cannot be removed. Wait for the descaling process to finish, then remove the brew group.

## Instructions to follow in case of descaling process interruption

---

You can exit the descaling procedure by pressing the **ON/OFF**  button on the control panel. If the descaling procedure is interrupted before completion, proceed as follows:

- 1 Empty the water tank and wash it thoroughly.
- 2 Fill the water tank with fresh water up to the MAX level. Then switch on again the machine. The machine will warm up and perform an automatic rinse cycle.
- 3 Before any brewing, we suggest you to run a manual rinse cycle as described in the dedicated chapter.

**Note:** if this procedure has not been completed, it will be necessary to carry out a new descaling cycle as soon as possible.

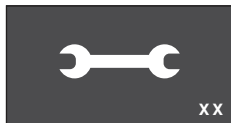

## Error code key

The list below reports the error codes that the display can show, their meanings and how to solve the problem. If the indicated solutions are ineffective because the display continues to show the error code icon and the machine does not return to normal operation, or if other error codes are displayed, you must contact an authorized service center or distributors in your country.

The contact info is listed on [www.gaggia.com](http://www.gaggia.com) and [www.gaggia.it](http://www.gaggia.it).

Error code	Problem	Cause	Possible solution
01	The coffee grinder is clogged.	The coffee outlet duct is clogged.	Remove the power cord and remove the brew group. Clean the coffee outlet duct thoroughly using a spoon handle. Switch the appliance back on again.
03 - 04	A problem occurred in the brew group.	The brew group is dirty or not well lubricated..	Switch off the machine. Remove the brew group and clean it thoroughly. (Refer to the "Cleaning the Brew Group" chapter)
		The brew group is not positioned correctly.	Switch off the machine. Remove the brew group and reinsert it. Ensure that the brew group is in the correct position before inserting it. Refer to the "Reinserting the brew group" chapter.
05	A problem occurred in the water circuit.	There is air in the water circuit.	Remove and reinsert the tank in the machine a couple of times. Make sure you insert the tank correctly in the machine. Check that the water tank seat is clean.
			If you use an "INTENZA+" filter: pull out the filter from the water tank and shake it to remove the air from the filter. Then place the "INTENZA+" filter back into the water tank.
14	The machine is overheated.	There may be multiple causes.	Switch off the machine and switch it back on again after 30 minutes. Perform this operation 2 or 3 times.









## Troubleshooting

This chapter outlines the most common problems you may encounter while using the machine. If you are unable to solve the problem using the information provided below, visit the FAQ sections on [www.gaggia.com](http://www.gaggia.com) or [www.gaggia.it](http://www.gaggia.it) or contact either the Customer Service Centre or the local distributors in your country.

Problem	Cause	Solution
The machine does not switch on.	The machine is not connected.	Check that the power cord has been inserted correctly.
	The on / off button was not pressed and held down long enough.	Keep the on / off button pressed for a few seconds.
The internal drip tray fills quickly.	It is a normal phenomenon. The machine uses water to rinse the internal circuit and the brew group. Part of the water flows through the internal system directly into the drip tray.	Empty the internal drip tray whenever the machine requires it.
The red "full drip tray" indicator is blocked.	The external drip tray is to be cleaned.	Clean the external drip tray and the part below the indicator with running water and a little dishwashing detergent.
The "Empty coffee pucks container" alarm remains on.	The coffee pucks container has been emptied when the machine was off or was placed back too quickly.	Empty the coffee pucks container when the machine is on and always wait about 5 seconds before placing it back. This will reset the counter.
The machine requests to empty the coffee pucks container, even if the container is not full.	The coffee pucks container has been put back too quickly.	Empty the coffee pucks container when the machine is on and always wait about 5 seconds before placing it back. This resets the coffee pucks counter and the number of coffee pucks is counted correctly.
The coffee pucks container is too full and the "Empty coffee pucks container" alarm did not appear on the display.	The internal drip tray has been emptied without also emptying the coffee pucks container.	When removing the internal drip tray, empty the coffee pucks container, even if it is almost empty. This ensures that the coffee pucks counter is reset and the number of coffee pucks is counted correctly.
	The coffee pucks container has been emptied when the machine was off.	Empty the coffee pucks container when the machine is on.
Impossible to remove the brew group.	The brew group is not in the correct position.	To reset the machine: close the service door, switch the machine off and on and wait for the machine to be ready for use. Try removing the brew group again.

Problem	Cause	Solution
The brew group cannot be inserted.	The brew group is not in the correct position.	The brew group has not been positioned correctly before being placed back. Ensure that the lever is in contact with the base of the brew group and that the hook of the brew group is in its correct position. See the "Reinserting the brew group" chapter.  To reset the machine: insert the coffee pucks container and the internal drip tray, without inserting the brew group. Close the service door and pull the plug out of the socket. Reinsert the plug, switch the machine on again, then try reinserting the brew group.
The espresso is not creamy enough or it is watery.	The coffee grinder is set to a coarse grinding.	Adjust the coffee grinder to a finer setting.
	The Espresso Plus System is not in the correct position.	Position the knob on the area that on the display indicates a more intense taste and richer crema.
	The coffee outlet duct is clogged.	Clean the coffee outlet duct with a spoon as described in the "Cleaning the brew group under running water" chapter.
The brewed coffee is not hot enough.	The brewed coffee is not hot enough.	Set the menu temperature to "MAX".
	The cups are not hot.	Heat the cups using the cup warmer.
The machine grinds the coffee beans, but no brewing happens.	The coffee grinder is set to a too fine grinding.	Adjust the coffee grinder to a coarser grind and wash the brew group.
	The coffee dispensing spout is blocked.	Dispense a long coffee from pre-ground coffee but without actually adding pre-ground coffee.
	The nozzles of the coffee dispensing spout are blocked.	Clean the nozzles of the coffee dispensing spout with a small bottlebrush.
The coffee comes out slowly or in drops.	The coffee grinder is set to a too fine grinding.	Adjust the coffee grinder to a coarser grind and wash the brew group.
	The nozzles of the coffee dispensing spout are blocked.	Clean the nozzles of the coffee dispensing spout with a small bottlebrush.
	The machine circuit is clogged by limescale.	Descale the machine.
The "Close coffee bean container lids" alarm remains on.	The aroma lid has not been inserted.	Insert the aroma lid before closing the coffee bean container lid.
Changes entered in the machine settings are not implemented.	Changes to the settings for stand-by time, cup warmer and timer, as well as button sounds have been entered when the ECO MODE was on.	Disable the ECO MODE function to implement the required changes.

Problem	Cause	Solution
The milk does not froth.	The milk dispensing spout is dirty or the carafe has not been inserted correctly, or the milk carafe has not been assembled with all its parts.	Clean the carafe according to the "Accurate cleaning of the milk carafe under running water" chapter and ensure that it is positioned and inserted correctly. <hr/> Ensure that all components have been correctly assembled.
	The steam wand nozzle is clogged.	Wash the steam nozzle with running water and clean the circuit using the <b>PURGE</b>  button.
	The type of milk used is not suitable for foaming, such as rice or coconut milk.	The amount and the quality of froth vary depending on the type of milk.
The "INTENZA+" filter cannot be inserted.	Remove the air from the filter.	Let the air bubbles out of the filter.
	The tank still contains some water.	Empty the water tank before installing the filter.
	The rubber seal is not inserted onto the "INTENZA+" filter.	Check the packaging and insert the seal onto the "INTENZA+" filter.
You can not activate the "INTENZA+" filter.	Another filter is already active.	The machine indicates the filter usage in percentage. However, if you want to activate a new filter before the one currently in use has expired, the latter must be disabled first as described in the section "Replacing INTENZA+ water filter".
There is some water under the machine.	The internal drip tray has not been inserted.	Insert the dip tray.
The machine does not respond to commands and DEMO has appeared on the display.	You mistakenly entered in the DEMO mode, for retailers only, via a button combination.	Exit this mode via the button combination <b>(ON/OFF</b>  - <b>HOME</b>  - <b>CLEAN/SET</b>   - <b>PURGE</b>  ).
The machine does not require saving via the MEMO function.	You are dispensing from the HOME screen and not from the PROFILES one.	To use the MEMO function, you should dispense from the PROFILES screen.

## GAGGIA accessories

Coffee and machine accessories can be ordered in the authorised centres in Italy or dealers in your country.



Descaler



INTENZA+ water filter



Coffee oil remover pads



Milk circuit cleaner  
(Philips)



Coffee range - available in beans and powder: 100% Arabica / Intense / Decaffeinated

## Technical specifications

Nominal voltage - Power rating - Power supply	See data plate inside the service door
Machine body material	Thermoplastic/Metal/Glass
Dimensions	282 x 385 x 428 mm
Weight	13,8 Kg
Power cord length	1200 mm
Control panel	Front panel
Cup size	Up to 110 mm with dispensing spout inserted, 155 mm without it
Water tank	1.6 litres - Removable type
Coffee beans container capacity	350 g
coffee pucks container capacity	14
Pump pressure	15 bar
Boiler	Stainless steel boiler
Safety devices	Thermal fuse

**GAGGIA** S.p.a. reserves the right to make any necessary modification.

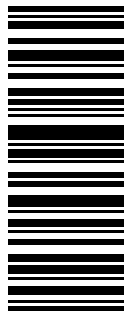

421946309642

COD.

- Rev.00 - 02/12/22

**GAGGIA** S.p.A.

Sede Amministrativa/Administrative Office

Via Torretta, 240

40041 Gaggio Montano - Bologna - Italia

+39 0534 771111

[www.gaggia.it](http://www.gaggia.it)

[www.gaggia.com](http://www.gaggia.com)

**GAGGIA**  
**MILANO**