

EMF2

MILK FROTHER
Instruction for use

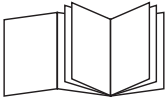

DeLonghi



ELECTRICAL CONNECTION (UK ONLY)

Before using this appliance ensure that the voltage indicated on the product corresponds with the main voltage in your home, if you are in any doubt about your supply contact your local electricity company.

The flexible mains lead is supplied connected to a B.S. 1363 fused plug having a fuse of 13 amp capacity. Should this plug not fit the socket outlets in your home, it should be cut off and replaced with a suitable plug, following the procedure outlined below.

Note: Such a plug cannot be used for any other appliance and should therefore be properly disposed of and not left where children might find it and plug it into a supply socket - with the obvious consequent danger.

N.B. We recommend the use of good quality plugs and wall sockets that can be switched off when the machine is not in use.

IMPORTANT: the wires in the mains lead fitted to this appliance are coloured in accordance with the following code:

GREEN AND YELLOW	EARTH
BLUE	NEUTRAL
BROWN	LIVE

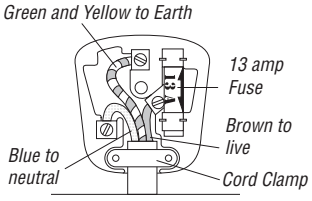

As the colours of the wires in the mains lead of this appliance may not correspond with the coloured markings identifying the terminals in your plug, proceed as follows:

- The wire which is coloured green and yellow must be connected to the terminal in the plug which is marked with the letter E or by the earth symbol  or coloured green or green and yellow.
- The wire which is coloured blue must be connected to the terminal which is marked with the letter N or coloured black.
- The wire which is coloured brown must be connected to the terminal which is marked with the letter L or coloured red.

When wiring the plug, ensure that all strands of wire are securely retained in each terminal. Do not forget to tighten the mains lead clamp on the plug. If your electricity supply point has only two pin socket outlets, or if you are in doubt, consult a qualified electrician.

Should the mains lead ever require replacement, it is essential that this operation be carried out by a qualified electrician and should only be replaced with a flexible cord of the same size.

After replacement of a fuse in the plug, the fuse cover must be refitted. If the fuse cover is lost, the plug must not be used until a replacement cover is obtained. The colour of the correct replacement fuse cover is that of the coloured insert in the base of the fuse recess or elsewhere on the plug. Always state this colour when ordering a replacement fuse cover.

Only 13amp replacement fuses which are asta approved to B.S. 1362 should be fitted.

This appliance conforms to the Norms EN 55014 regarding the suppression of radio interference.

Warning - this appliance must be earthed

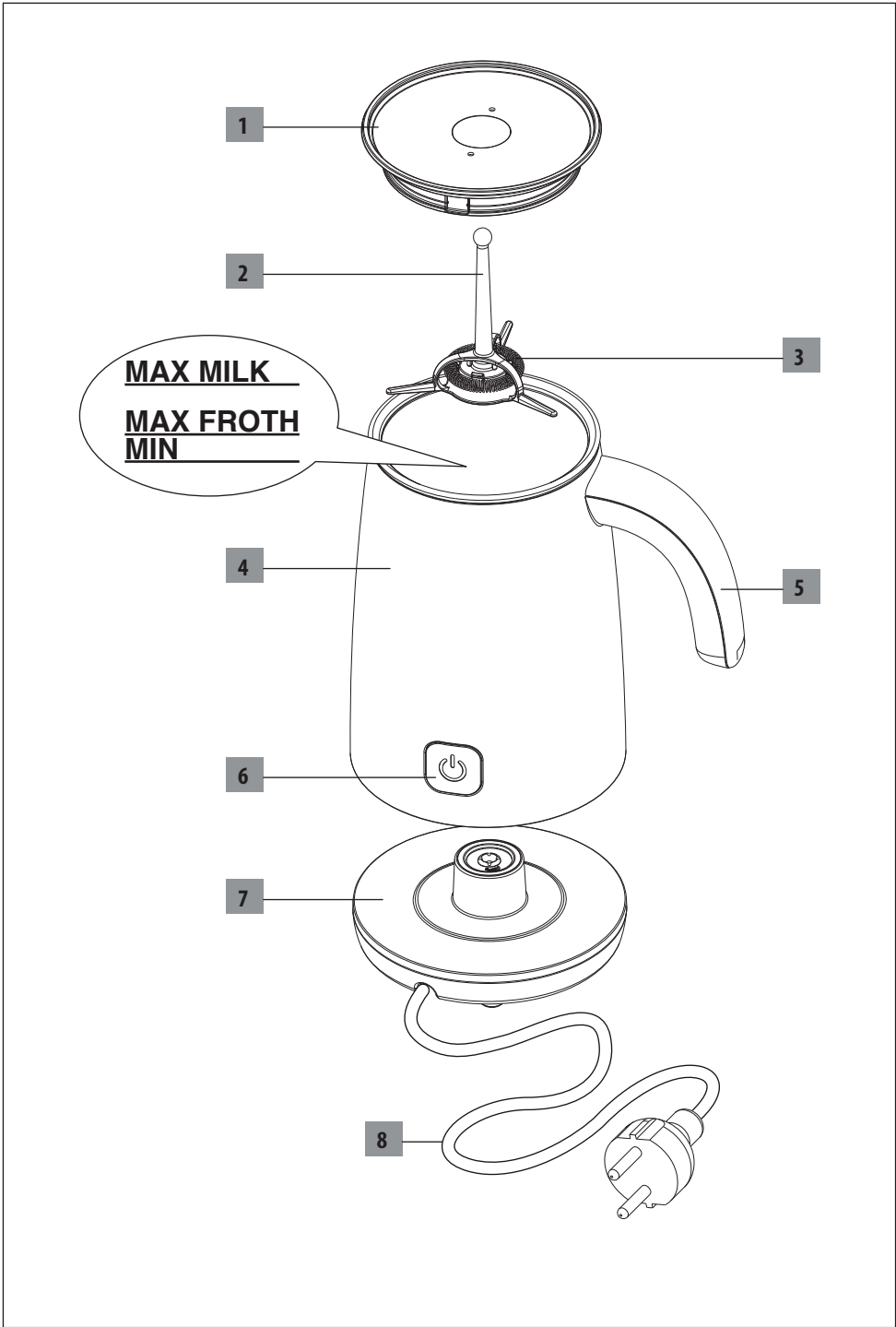

USE

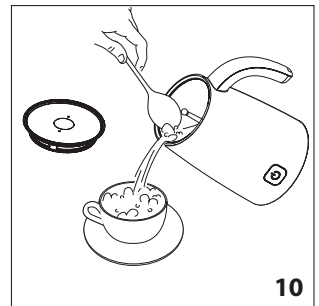
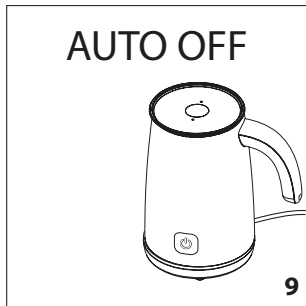
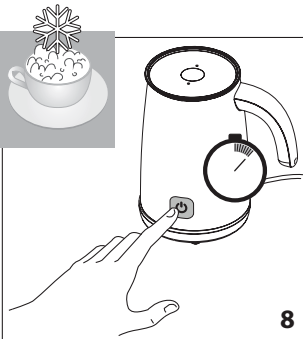
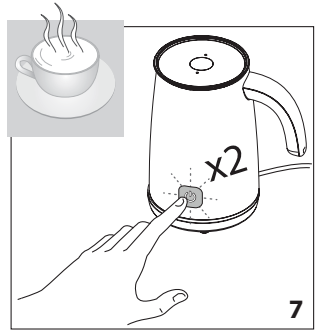
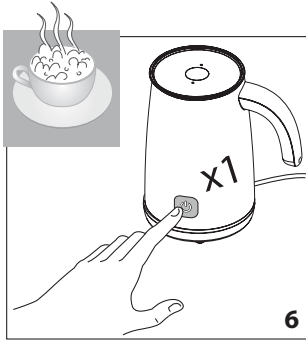
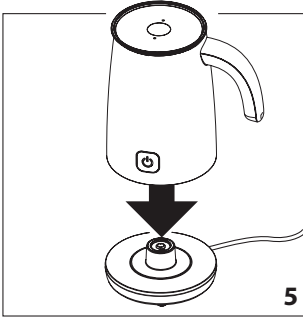
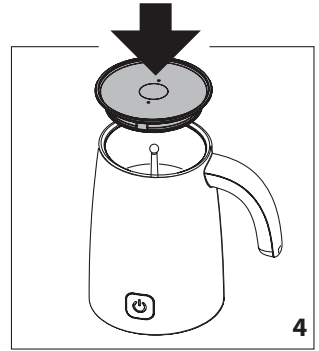
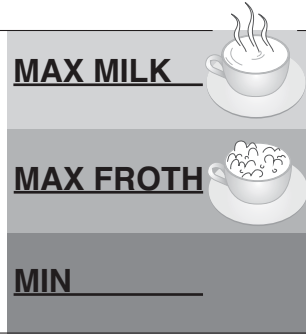
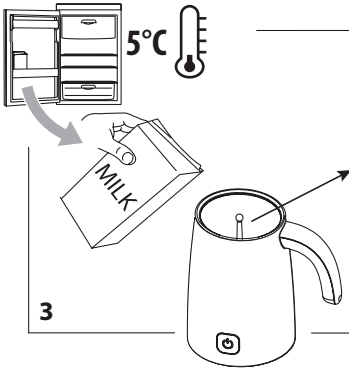
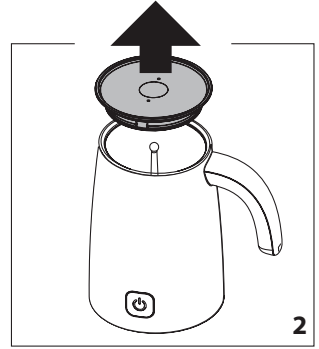
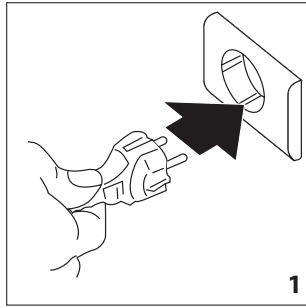

CLEANING

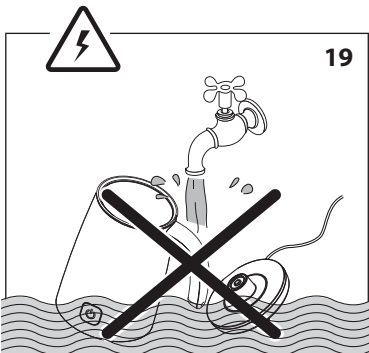
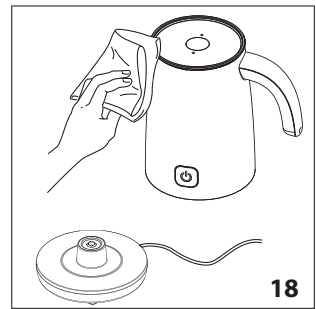
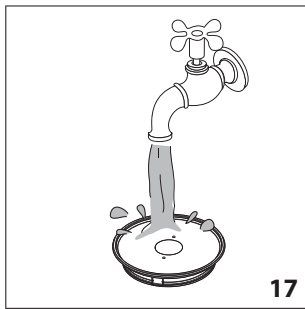
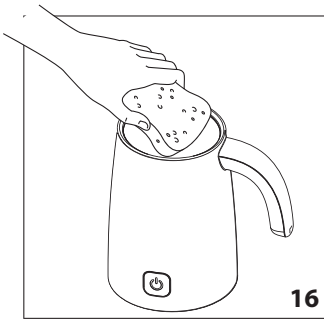
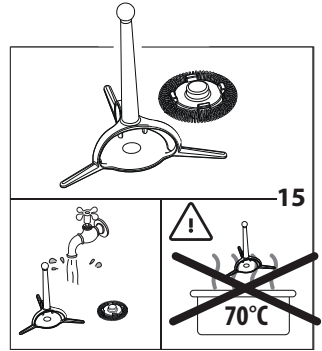
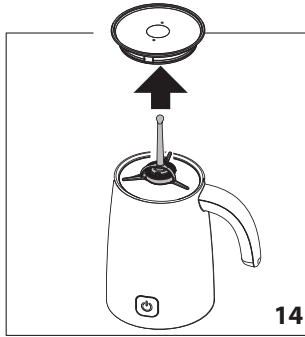
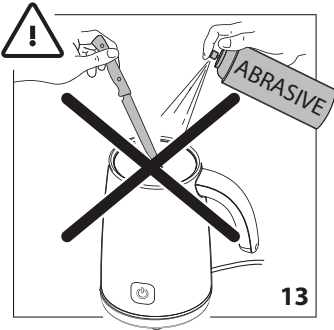
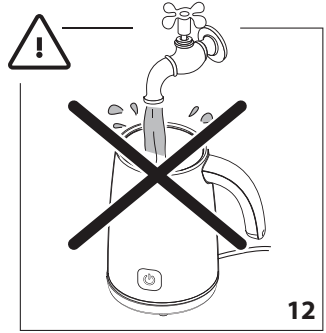
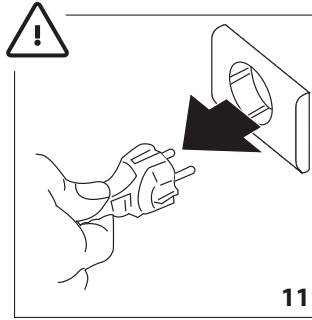

FUNDAMENTAL SAFETY WARNINGS

- The appliance is not intended for use by persons (including children) with reduced physical, sensory or mental capabilities, or lack of experience and knowledge, unless they have been given supervision or instruction concerning use of the appliance by a person responsible for their safety.
- Children should be supervised to ensure that they do not play with the appliance.
- Cleaning and user maintenance shall not be made by children without supervision.
- Never clean by immersing the appliance in water.
- This is an household appliance only. It is not intended to be used in: staff kitchen areas in shops, offices and other working environments; farm houses; by clients in hotels, motels and other residential type environments; bed and breakfast type environments.
- If the plug or power cable is damaged, it must be replaced by customer services only to avoid all risk.
- Only to be used with the stand provided.

FOR EUROPEAN MARKETS ONLY:

- This appliance can be used by children aged from 8 years and above if they have been given supervision or instruction concerning use of the appliance in a safe way and if they understand the hazard involved. Cleaning and user maintenance shall not be made by children unless they are older than 8 and supervised.
Keep the appliance and its cord out of the reach of children aged less than 8 years.
- Appliances can be used by persons with reduced physical, sensory or mental capabilities or lack of experience and knowledge if they have been given supervision or instruction concerning use of the appliance in a safe way and if they understand the hazards involved.
- Children shall not play with the appliance.
- When not in use and before putting on or taking off parts or cleaning, always unplug the appliance.



Surfaces marked with this symbol become hot during use (the symbol is present in certain models only).

IMPORTANT SAFEGUARDS

Symbols used in these instructions

Important warnings are identified by these symbols. It is vital to respect these warnings.



Danger!

Failure to observe the warning may result in life threatening injury by electric shock.



Important!

Failure to observe the warning could result in injury or damage to the appliance.



Danger of burns!

Failure to observe the warning could result in scalds or burns.



Please note:

This symbol identifies important advice or information for the user.



Danger!

This is an electrical appliance and may cause electric shock.

You should therefore follow these safety warnings:

- Never touch the appliance with damp hands or feet.
- Never touch the plug with damp hands.
- Avoid spilling liquid on the connector.
- Do not place on or near a hot gas or electric burner, or in a heated oven.
- Make sure the socket used is freely accessible at all times, enabling the appliance to be unplugged when necessary.
- Unplug directly from the plug only. Never pull the cord as you could damage it.
- Do not let cord hang over edge of table or counter, or touch hot surfaces.
- To disconnect the appliance completely you must unplug it from the mains socket.
- If the appliance is faulty, do not attempt to repair. Turn it off, unplug from the mains socket and contact Customer Services.
- Before cleaning the appliance, turn it off, unplug from the mains socket and allow to cool (fig. 11).
- During cleaning, never immerse the base and boiler in water. This is an electrical appliance (fig. 19).



Important:

- After removing the packaging, make sure the product is complete and undamaged and that all accessories are present.
- Keep all packaging (plastic bags, polystyrene foam) away from children.
- All inappropriate uses may cause injury.
- Use the appliance on a flat surface.

- Do not use the appliance if it is visibly damaged. Contact Customer Services.
- Make sure the lid is tightly closed before operating the appliance.



Danger of burns!

- When using the appliance do not touch the hot surfaces. Use the buttons or handles.
- The surface of the heating element remains hot after use.
- Never exceed the maximum level indicated in the appliance (fig. 3). If this level is exceeded, hot milk may leak from the lid and result in scald.

Instruction for Use

Read this Instruction for Use carefully before using the appliance.

Failure to follow this Instruction for Use may result in burns or damage to the appliance.

The manufacturer is not liable for damage deriving from failure to respect this Instruction for Use.





Please note:

- Keep this Instruction for Use. If the appliance is passed to other persons, they must also be provided with this Instruction for Use.

DESCRIPTION (page 3)

- A. Lid
- B. Hot/frothed milk accessory
- C. Whisk
- D. Milk container
- E. Milk container handle
- F. ON/OFF/function button
- G. Base with electrical connector
- H. Power cord

PREPARING MILK

Hot frothed milk	 red LED	Press once (fig. 6)
Hot milk (not frothed)	 flashing red LED	Press twice (fig. 7)
Cold frothed milk	 blue LED	press and hold for a few seconds (fig. 8)

TIPS FOR USE AND CLEANING

The first time the appliance is used, all the accessories and internal components should be washed with water. Then make a few preparations using water instead of milk.



Please note:

Preparation can be interrupted at any moment by simply lifting the milk container from the base or pressing the  button once.



Never wash in a dishwasher.

- Never use solvents, abrasive detergents or alcohol to clean the appliance (fig. 13).

TECHNICAL DATA

Voltage:	220-240 V~ 50/60 Hz max. 10A
Absorbed power:	420-500W
Size DxWxH:	120x170x200 mm
Cord length:	800 mm
Weight:	0,8 kg



The appliance complies with the following EC directives:

- Low Voltage Directive 2006/95/EC and subsequent amendments;
- EMC Directive 2004/108/EC and subsequent amendments;
- European Standby Regulation 1275/2008
- Materials and accessories coming into contact with food conform to EEC regulation 1935/2004.

DISPOSAL



In compliance with European directive 2012/19/EC, the appliance must not be disposed of with household waste, but taken to an authorised waste separation and recycling centre.

TROUBLESHOOTING

Problem	Cause	Solution
The appliance does not come on	It is not plugged into the mains socket.	Plug into the mains.
	The appliance has a safety device which imposes a 30 second pause between one preparation and the next.	Wait, then select the required function.
There is little or no froth on the milk	The "Hot milk (not frothed)" function is selected.	Prepare the milk again, using milk at refrigerator temperature and pressing the function button once (red LED on steadily).
	The milk is too hot.	Use milk at refrigerator temperature.
	After cleaning, the whisk (C) has not been replaced in the hot/frothed milk accessory, or the whole accessory is absent or incorrectly positioned.	Insert the whisk in the accessory and make sure the accessory is correctly positioned in the appliance.
The milk overflows.	Too much milk has been placed in the container.	Always respect the MAX quantity indicated for each preparation.
	The appliance is standing on a sloping surface.	The appliance must always be operated on a flat surface.
The blue LED flashes 	The appliance has been operated without milk.	Remove the appliance from the base. Wait until it cools down. To cool it down faster, pour milk at refrigerator temperature into the container.