

*the Oracle™*

SES980



**Sage®**

2 Sage® Recommends Safety First  
5 Know your new appliance  
7 Operating your new appliance  
17 Care & cleaning  
23 Troubleshooting

# SAGE® RECOMMENDS SAFETY FIRST

**At Sage® we are very safety conscious. We design and manufacture consumer products with the safety of you, our valued customer, foremost in mind. In addition we ask that you exercise a degree of care when using any electrical appliance and adhere to the following precautions.**

## IMPORTANT SAFEGUARDS

**READ ALL INSTRUCTIONS  
BEFORE USE AND SAVE  
FOR FUTURE REFERENCE**

- The full information book is available at [sageappliances.com](http://sageappliances.com)

- Before using for the first time please ensure that your electricity supply is the same as shown on the rating label on the underside of the appliance. If you have any concerns please contact your local electricity company.
- Remove any packaging material and promotional labels or stickers before using the Oracle™ for the first time.
- To eliminate a choking hazard for young children, remove and safely discard the protective cover fitted to the power plug of this appliance.
- Do not place the product near the edge of a bench or table during operation. Ensure the surface is level, clean and free of water and other substances.
- Do not let the cord hang over the edge of a bench or table, or become knotted. Keep away from hot gas or electric burner, or where it could touch a heated oven.
- Appliances can be used by persons with reduced physical, sensory or mental capabilities or lack of experience and knowledge if they have been given supervision or instruction concerning use of the appliance

## WE RECOMMEND SAFETY FIRST

in a safe way and understand the hazards involved.

- Children shall not play with the appliance.
- Regularly inspect the supply cord, plug and actual appliance for any damage. If found damaged in any way, immediately cease use of the appliance and return the entire appliance to the nearest authorised Sage Service Centre for examination, replacement or repair.
- Keep the appliance and accessories clean. Follow the cleaning instructions provided in this book. Any procedure not listed in this instruction booklet should be performed at an authorised Sage Service Centre.
- The installation of a current device (safety switch) is recommended to provide additional safety protection when using electrical appliances. It is advisable that a safety switch with a rated residual operating current not exceeding 30mA be installed in the electrical circuit supplying the appliance. See your electrician for professional advice.

## SPECIFIC INSTRUCTIONS FOR SES980 THE ORACLE™

- This appliance is recommended for household use only. Do not use this appliance for any purpose other than its intended use. Do not use in moving vehicles or boats. Do not use outdoors.
- If the appliance is to be:
  - left unattended
  - cleaned
  - moved
  - assembled; or
  - stored

Always switch Off the espresso machine by pressing the Power button to Off, switch Off at the power outlet and unplug.

- Ensure the product is properly assembled before first use.
- Do not use any other liquid apart from cold mains/town water. We do not recommend the use of highly filtered, de-mineralised or distilled water as this may affect the taste of the coffee and how the espresso machine is designed to function.
- Ensure the portafilter is firmly inserted and secured into the group head before starting an extraction. Never remove

## WE RECOMMEND SAFETY FIRST

the portafilter during the extraction process.

- Do not touch hot surfaces. Allow the product to cool down before moving or cleaning any parts.
- Use caution after milk texturing as the 'Auto Purge' function may purge hot steam when the steam wand is lowered.
- Use caution when operating machine as metal surfaces are liable to get hot during use.
- Use caution when using the de-scale feature as hot steam may be released. Before de-scaling, ensure drip tray is empty and inserted. Refer to page 21 for further instructions.
- Heating element surface is subject to residual heat after use.

## SPECIFIC INSTRUCTIONS FOR WATER FILTER

- Filter cartridge should be kept out of reach of children.
- Store filter cartridges in a dry place in the original packaging.
- Protect cartridges from heat and direct sunlight.
- Do not use damaged filter cartridges.
- Do not open filter cartridges.
- If you are absent for a prolonged period of time, empty the water tank and replace the cartridge.



The symbol shown indicates that this appliance should not be disposed of in normal household waste.

It should be taken to a local authority waste collection centre designated for this purpose or to a dealer providing this service. For more information, please contact your local council office.



To protect against electric shock, do not immerse the power cord, power plug or appliance in water or any other liquid.

## SAVE THESE INSTRUCTIONS

## KNOW YOUR NEW APPLIANCE

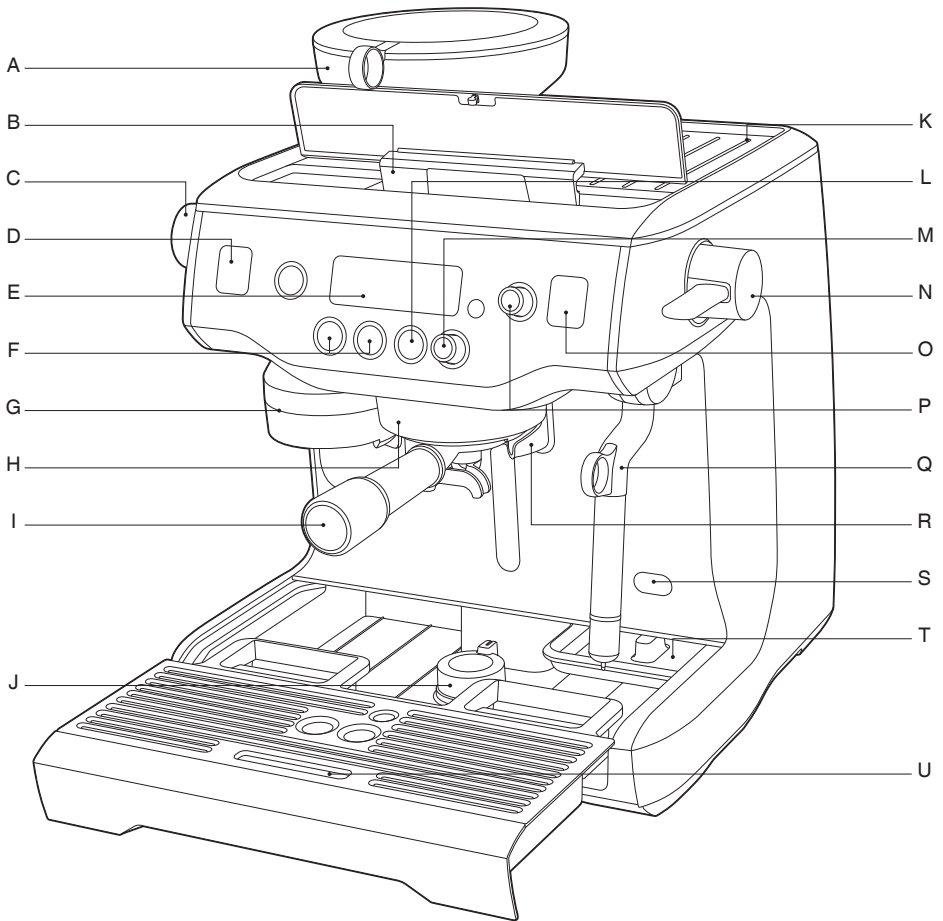

- A. Integrated conical burr grinder
- B. Top-fill 2.5L removable water tank
- C. Grind Size dial
- D. Grind LCD
- E. Main LCD
- F. 1 CUP and 2 CUP buttons
- G. Grind outlet
- H. Heated 58mm group head with
- I. 58mm full stainless steel portafilter
- J. Drop down swivel foot
- K. Heated cup warming tray

- L. HOT WATER button
- M. LONG BLACK dial
- N. Steam lever
- O. Steam LCD
- P. SELECT dial
- Q. Cool touch steam wand
- R. Dedicated hot water outlet
- S. Descale access point
- T. Tool storage tray
- U. Removable drip tray

## KNOW YOUR NEW APPLIANCE

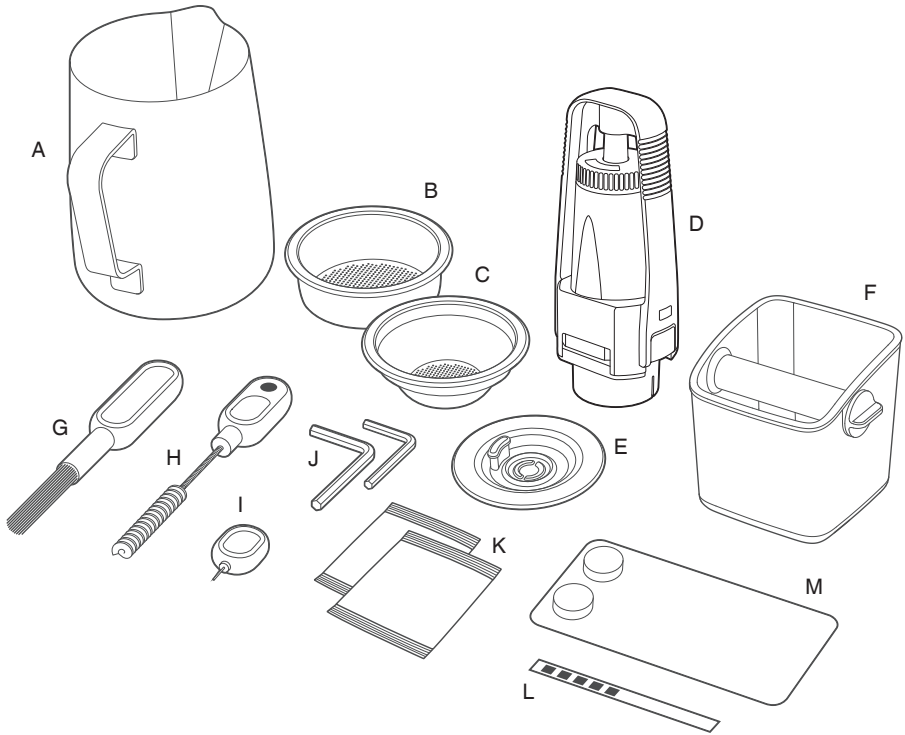

### ACCESSORIES

- A. Stainless steel milk jug
- B. 2 cup filter basket
- C. 1 cup filter basket
- D. Water filter holder with filter
- E. Cleaning disc
- F. Mini grinds bin
- G. Burr brush
- H. Grind outlet brush & tamp removal magnet
- I. Cleaning tool for steam wand tip
- J. Allen key
- K. Steam wand cleaning powder
- L. Water hardness test strip
- M. Espresso cleaning tablets

**CE** Rating Information  
220-240V~50-60Hz 2000-2400W

# OPERATING YOUR NEW APPLIANCE

## BEFORE FIRST USE

### Machine Preparation

Remove and discard all labels and packaging materials attached to your espresso machine. Ensure you have removed all parts and accessories before discarding the packaging.

Clean parts and accessories (water tank, portafilter, filter basket, jug) using warm water and a gentle dish washing liquid. Rinse well then dry thoroughly.

### TIP

To easily manoeuvre your machine, use the drop down swivel foot located under the drip tray.

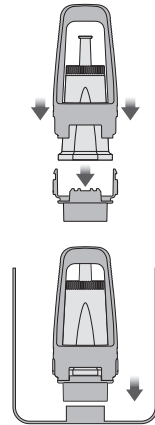

## INSTALLING THE WATER FILTER

- Remove the water filter and water filter holder from the plastic bag.
- Soak the filter in cold water for 5 minutes.
- Wash the filter holder with cold water.

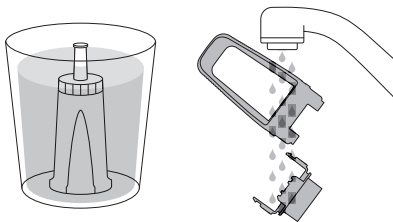

- Set the reminder for next month of replacement. We recommend to replace the filter after 3 months.

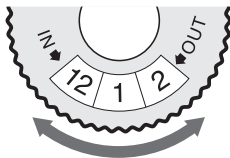

- Insert the filter into the two parts of the filter holder.
- To install the assembled filter holder into the water tank, align the base of the filter holder with the adapter inside the water tank. Push down to lock into place.

- Fill the water tank with cold water before sliding back into position at the back of the machine and locking into place.

## FIRST USE

1. Ensure tank is filled with cold water.
2. Press POWER button to turn machine on.
3. The main LCD will display 'Hrd3', prompting you to set the water hardness level.

### Setting Water Hardness

- Dip the test strip into a sample of the water you have filled the tank with. Wait for one minute. The water hardness setting is indicated by the number of red squares displayed on the test strip.
  - Rotate SELECT dial to the required setting from 'Hrd1' (softest water) to 'Hrd5' (hardest water). Press SELECT dial to set.
4. After approximately 5 minutes, the machine will reach the default operating temperature 93°C and all 6 buttons will illuminate. The machine is now in STANDBY mode.

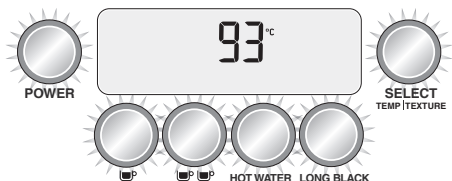

## OPERATING YOUR NEW APPLIANCE

### Flushing The Machine

When the machine has reached STANDBY mode:

1. Press 2 CUP button to run water through the group head for 30 seconds.
2. Press HOT WATER button to run water through the hot water outlet. After 30 seconds, press HOT WATER button again to stop the flow of water.
3. Lift steam lever to the MANUAL position to release steam through the steam wand. After 30 seconds, lower the steam lever to the centre OFF position.
4. Repeat steps 1–3 twice.

### MANUAL will flash on LCD

The machine will not reach operating temperature (STANDBY mode) if the steam lever is in the MANUAL position. The steam LCD will display 'MANUAL'. Lower the steam lever to the centre OFF position.

Steam operation is ready when the SELECT dial illuminates.

### NOTE

You will not be able to select the 1 CUP, 2 CUP or LONG BLACK functions; or access the cleaning cycle in the menu options until the machine has reached operating temperature (STANDBY mode).

### GRINDING OPERATION

Insert bean hopper into position on top of the machine. Turn knob to lock into place. Fill hopper with fresh beans.

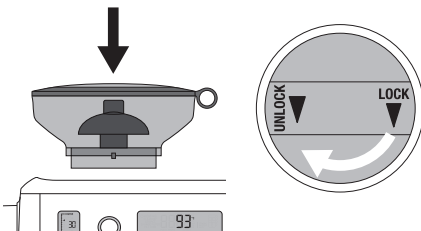

### SELECTING GRIND SIZE

There are 45 espresso grind size settings (No. 1 – finest, No. 45 – coarsest) to enable you to select the right grind size for your coffee beans and achieve the perfect espresso extraction.

We recommend you start at No. 30 and adjust as required to control espresso flow rate.

### SELECT YOUR FILTER BASKET

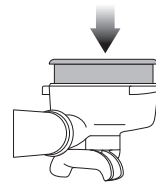

Use the 1 Cup Filter Basket for making a single cup or a weaker tasting espresso.

Use the 2 Cup Filter Basket for making 2 cups or a stronger tasting espresso, usually for mugs or larger cups.

### AUTO GRIND DOSE & TAMP

Align portafilter handle with the INSERT position on the grind outlet. Lift to insert portafilter into the grind outlet and rotate to the centre position.

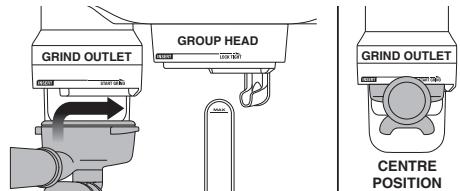

To start the auto grind, dose & tamp function, rotate the portafilter to the right then gently guide back to the centre position. Grinding will commence.

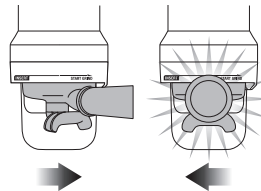

When the auto grind, dose & tamp function is complete, rotate the portafilter handle to the INSERT position and lower to remove.





# OPERATING YOUR NEW APPLIANCE

## ESPRESSO EXTRACTION

Align portafilter handle with the INSERT position on the group head. Lift to insert portafilter into the group head and rotate towards the LOCK TIGHT position until resistance is felt.

## EXTRACTION GUIDE

The 1 CUP button  and 2 CUP button  use duration to control espresso volume. The duration times are preset, but can be reprogrammed.

### 1 CUP BUTTON

Press 1 CUP button once to extract a single shot of espresso.

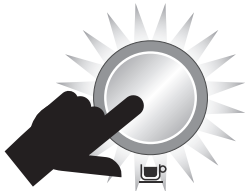

### 2 CUP BUTTON

Press 2 CUP button once to extract a double shot of espresso.



The machine will stop after 2 CUP duration has been extracted and will return to STANDBY mode.

EXTRACTION TYPES	GRIND	SHOT DURATION
<b>OVER-EXTRACTED</b> (bitter • astringent)	Too Fine	Over 45secs
<b>BALANCED</b>	Optimum	Between 15-40secs
<b>UNDER-EXTRACTED</b> (underdeveloped • sour)	Too Coarse	Less than 15secs

Press and hold either the 1 CUP or 2 CUP button to commence pre-infusion. When the required pre-infusion duration is met, release the button to begin full pump pressure.

Press the button again to stop the pour when required duration has been achieved.

## TEXTURING MILK

The SELECT dial is used to select milk temperature and texture. Press the dial to toggle between milk temperature and texture.

## ADJUSTING MILK TEMPERATURE

Press the SELECT dial until the milk temperature flashes. Rotate the dial to increase or decrease milk temperature.

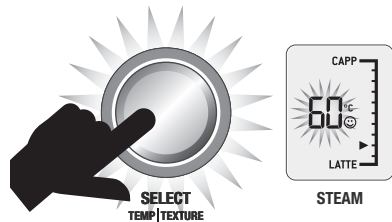

## ADJUSTING MILK TEXTURE

Press the SELECT dial until the milk texture triangle flashes. Rotate dial towards 'CAPP' for more texture or 'LATTE' for less texture.

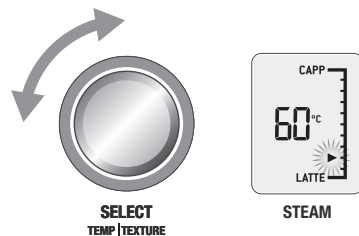

## NOTE

Prior to texturing milk, always purge steam wand by momentarily pressing down the steam lever.

## AUTO MILK TEXTURING

## MANUAL OVERRIDE

## OPERATING YOUR NEW APPLIANCE

Start with fresh cold milk. Fill milk jug to below the spout position. Lift steam wand and insert into milk jug. Lower steam wand, ensuring it is fully down. The milk jug should rest on the drip tray and milk should cover the steam wand seal.

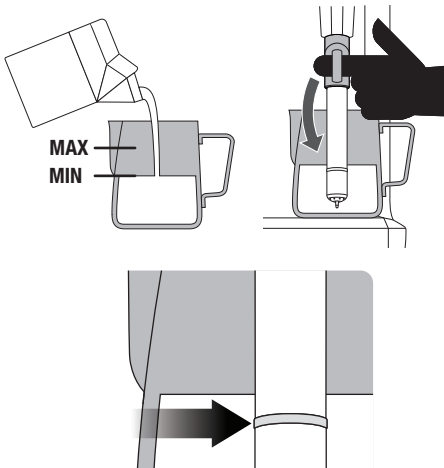

To start, press down and release steam lever. Milk texturing will stop automatically when the selected milk temperature is reached. Lift steam wand to remove milk jug. **Wipe the wand and tip with a damp cloth.** Lower steam wand to the down position and the wand will automatically purge.

### MANUAL MILK TEXTURING

Auto milk texturing and auto shut-off are disabled during manual milk texturing mode.

Insert steam wand into milk jug. Lift steam lever to activate manual steam mode. Once the desired milk texture and temperature are achieved, lower the steam lever to the centre OFF position. **Wipe the wand and tip with a damp cloth.** Lower steam wand to the down position and the wand will automatically purge.

### CAUTION: BURN HAZARD

**Pressurised steam can still be released, even after machine has been switched off.**

**Children must always be supervised.**

### NOTE

If machine is run continuously for 30 minutes, allow machine to cool for 5 minutes before each use.

### PRESET LONG BLACK

There are 3 preset Long Black settings – small, medium and large. To use one of these settings:

1. Insert the 2 Cup Filter Basket into the Porta-filter.
2. Fill the portafilter using the auto grind, dose & tamp function.
3. Insert the portafilter into the group head.
4. Position your cup so the portafilter spouts and hot water outlet are directed inside the cup.

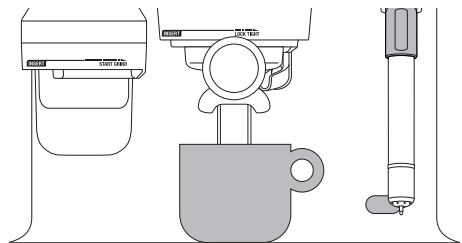

5. Rotate the LONG BLACK dial to the desired cup size.

PRESET CUP SIZE	AMOUNT BREWED
Small	Approx. 180ml
Medium	Approx. 240ml
Large	Approx. 355ml

*The brewed amounts are approximate only. Actual amounts may vary due to the coffee bean roast, blend and freshness as well as the selected grind size. These factors affect extraction rate and shot volume.*

6. To start extraction, press the LONG BLACK dial. Espresso will extract from the portafilter spouts, followed by hot water from the hot water outlet.

### MANUAL LONG BLACK

## OPERATING YOUR NEW APPLIANCE

This allows you total control over the Long Black process: pre-infusion duration, espresso volume and hot water volume. During manual Long Black mode, the LCD will show a moving cup icon.

Press and hold LONG BLACK dial to activate pre-infusion. Release LONG BLACK dial to commence espresso pour.

Press the LONG BLACK dial to stop espresso pour and commence hot water pour.

Press the LONG BLACK dial again to stop the pour of hot water.

### HOT WATER

The HOT WATER button can be used to pre-heat cups or add hot water manually.

To stop and start the pour of hot water, press the HOT WATER button.

To ensure water is dispensed at the correct temperature, hot water will cease to dispense after approx. 30 seconds. Depending on the size of your cup, you may need to press the HOT WATER button a second time.



#### NOTE

You cannot run hot water and extract espresso at the same time.

### PROGRAMMABLE FUNCTIONS

To enter program mode, press the MENU button. Rotate SELECT dial to the desired function.

Program mode allows you to program:

- Shot Volume
- Shot Temperature
- Clean Cycle
- Set Clock
- Auto Start
- Tamp Set
- Pre-Infusion
- Long Black Adjust

To exit program mode, press MENU button.

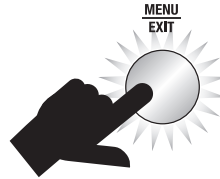
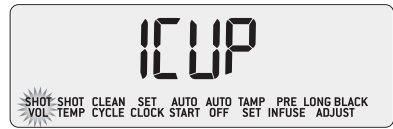

### PROGRAMMING SHOT VOLUME/DURATION

Fill the portafilter using the auto grind, dose & tamp function. Insert the portafilter into the group head.

While 'SHOT VOL' is displayed on the LCD, rotate the SELECT dial to '1 CUP' to reprogram the 1 CUP button, or '2 CUP' to reprogram the 2 CUP button. Press the SELECT dial to start espresso extraction. When required espresso volume/duration has been extracted, press SELECT dial to stop extraction. Machine will beep once to confirm the new volume/duration.

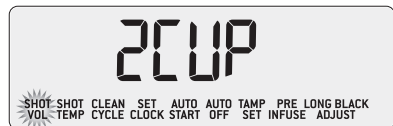

# OPERATING YOUR NEW APPLIANCE

## SHOT TEMPERATURE

Turn the SELECT dial to required temperature then press SELECT dial to set.

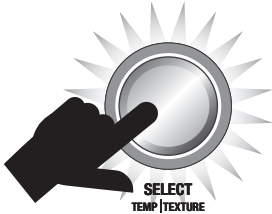
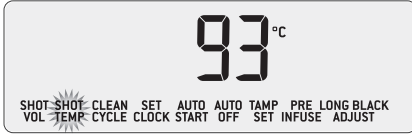

## SET CLOCK

Setting the clock is optional. While 'SET CLOCK' is displayed on the LCD, press the SELECT dial.

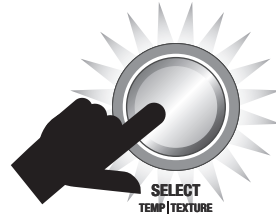

## CLEANING CYCLE

The cleaning cycle cleans the shower screen and back-flushes the group head. Select this feature when the LCD displays 'CLEAN ME!' Refer to 'Cleaning Cycle', page 30.

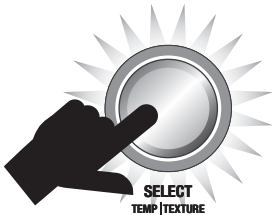
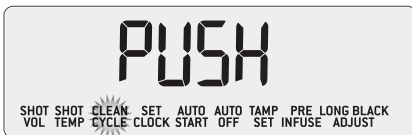

## AUTO START

Auto Start allows you to program the specific time when the machine will automatically turn on. By programming your machine, you will not have to wait for it to pre-heat.

While 'AUTO START' is displayed on the LCD, press the SELECT dial. Turn the SELECT dial to 'On' or 'Off'. Press SELECT dial to set.

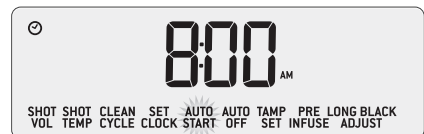
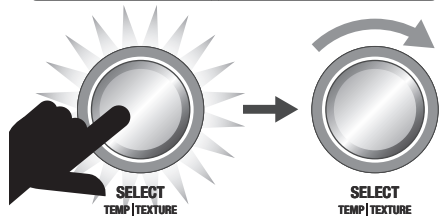

## OPERATING YOUR NEW APPLIANCE

### AUTO OFF MODE

The machine automatically switches to AUTO OFF mode after 30 minutes.

### TAMP SET

Adjusting tamp parameters allows for fine tuning of coffee tamping force and polishing duration. While 'TAMP SET' is displayed on the LCD, press the SELECT dial. The tamp force setting will flash.

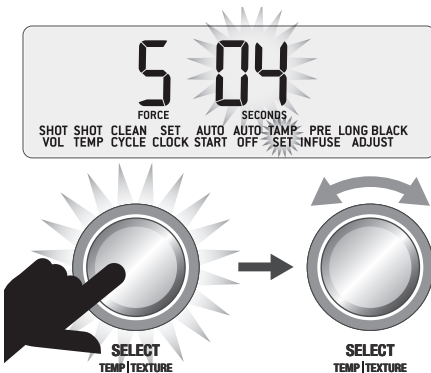
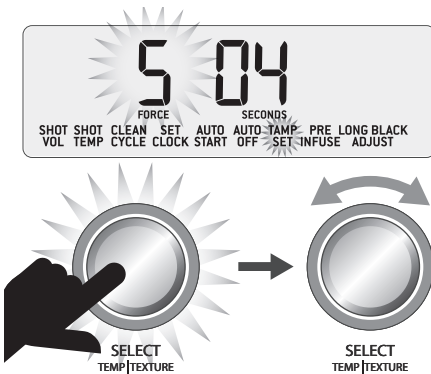

### PRE-INFUSION

Low pressure pre-infusion allows you to control the pressure and duration of the pre-infusion phase of the espresso extraction. While 'PRE INFUSE' is displayed on the LCD, press the SELECT dial. The pump power setting will flash. Turn SELECT dial to increase or decrease the pre-infusion pressure. Press SELECT dial to set and pre-infusion duration will flash. Turn SELECT dial to adjust seconds.

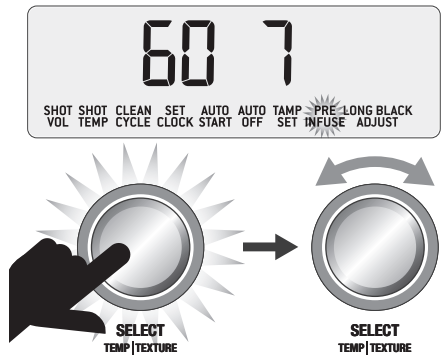

### LONG BLACK ADJUST - PROGRAMMING CUSTOM SETTINGS

There are 6 custom Long Black settings for you to program to suit your cup size and strength preferences. To program your custom setting:

1. Fill the portafilter using the auto grind, dose & tamp function.
2. Insert the portafilter into the group head.
3. Position your cup so the portafilter spouts and hot water outlet are directed inside the cup.
4. Press the MENU button. Rotate the SELECT dial to 'LONG BLACK ADJUST' then press the SELECT dial.

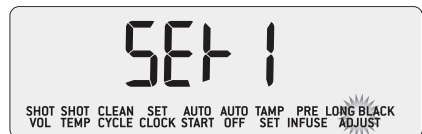

## OPERATING YOUR NEW APPLIANCE

5. Rotate the SELECT dial to the custom setting you'd like to program - 'Set 1' to 'Set 6'. Settings that have already been programmed will display a cup icon.



**NOT PROGRAMMED**



**PROGRAMMED**

6. To start programming, press the SELECT dial. The LCD will show a moving cup icon and espresso will extract from the portafilter spouts. When the required amount has been extracted, press the SELECT dial to stop the flow of espresso and start the flow of hot water. When the required amount of water has poured, press the SELECT dial to stop the flow of hot water.



**PROGRAMMED**

7. To use your custom Long Black setting, rotate the LONG BLACK dial. Your programmed custom Long Black setting will appear after the preset small, medium and large settings. Press the LONG BLACK dial and your programmed Long Black setting will dispense.

## ADVANCED FEATURES

These features should only be accessed by experienced users.

To access Advanced Features, with the machine turned off, press and hold the 1 CUP button, then press and hold the POWER button together for 3 seconds.

Rotate the SELECT dial to the desired feature. Press SELECT dial to access feature settings.

Press the MENU button at any time to exit Advanced Features.

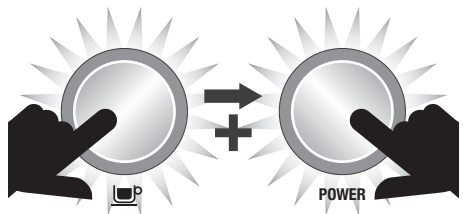

## Reset Default Settings (rSEt)

Use this function to reset all programmable values back to the default settings. The machine has the following default settings:

1. Shot Temperature: 93°C
2. Low Pressure Pre-infusion: PP60, PT07 seconds
3. Milk Temperature: 60°C
4. Auto Start: OFF (8:00am)
5. Auto Off: 20 min
6. Clock: 12:00am
7. 1 CUP Button Shot Duration: 25 seconds
8. 2 CUP Button Shot Duration: 30 seconds

While 'rSEt' is displayed on the LCD, press the SELECT dial to reset all settings to factory defaults.



## OPERATING YOUR NEW APPLIANCE

'Hrd3' will flash on screen. Machine is now in Water Hardness mode. See 'Water Hardness (Hrd3)' to set.

### Descale (dESc)

Select this feature to access the step by step descale procedure on the LCD.

### Water Hardness (Hrd3)

Rotate SELECT dial to the required setting from 'Hrd1' (softest water) to 'Hrd5' (hardest water). Press SELECT dial to set. Machine will beep once to confirm selection.

### Units (SEt)

Set units to metric or imperial.

### LCD Backlight (Lcd)

Adjust the LCD brightness/contrast.

### Spotlights (SPot)

Adjust the brightness of the LEDS lighting the drip tray area. Rotate SELECT dial to the desired brightness. Press SELECT dial to set.

### Steam Temperature (StEA)

Adjust the steam boiler temperature, which in turn controls steam pressure. Rotate SELECT dial to the desired temperature. The default is 130°C. Press SELECT dial to set.

### Air Pump Delay (Air)

Delay the operation of the air pump during automatic milk texturing. Rotate SELECT dial to the desired delay time.

### Sound (Snd)

Adjust the audible alerts. Rotate SELECT dial to the desired setting. Select between off (OFF), low (Lo) or high (Hi). Press SELECT dial to set.

### Fan Control (FAn)

Adjust the speed of the internal cooling fan. Rotate SELECT dial to the desired fan speed. Select between Silent (SILt), Standard (StNd) or cool (CooL). Press SELECT dial to set.

### Disable Clean Me! Alert (CIn)

Disables the 'CLEAN ME!' alert. Rotate SELECT dial to on (On) or off (OFF). The default setting is on. Press SELECT dial to set.

### 12h or 24h Clock (CLoC)

Display time in 12h or 24h format. Rotate SELECT dial to the desired unit. Press SELECT dial to set.

### Flow Measurement Method (VoL)

Select between volume based (FLo) or time based (SEc) method for espresso dose measurement. Rotate SELECT dial to the desired method. Press SELECT dial to set.

## ALERTS

### MANUAL will flash on steam LCD

The machine will not reach operating temperature (STANDBY mode) if the steam lever is in the MANUAL position. The steam LCD will display 'MANUAL'. Lower the steam lever to the centre OFF position.

Steam operation is ready when the SELECT dial illuminates.

### Fill Tank

The machine will detect a low water level. The LCD will display 'FILL TANK'.

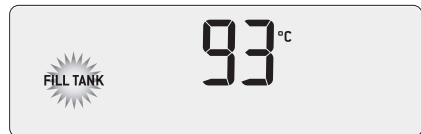

### Clean Me!

Indicates when 200 extractions have been carried out since the last cleaning cycle.

The cleaning cycle cleans the shower screen and back-flushes the group head.

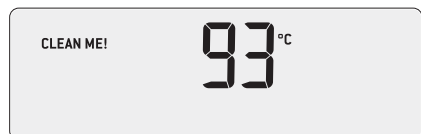

## OPERATING YOUR NEW APPLIANCE

### **Heating**

Indicates when the machine is heating up or if the temperature drops excessively during use.

### **Lock Hopper**

Indicates if the bean hopper has not been properly inserted and locked into position.

### **Overheat Please Wait**

Indicates if the grinder is used excessively and needs time to cool.

### **Change Filter**

Indicates when the water filter in the water tank needs to be replaced.

The regularity of this alert is determined by the water hardness setting (Hrd1-Hrd5) selected.

## **TRANSPORTING AND STORING**

We recommend draining both boilers completely before transporting the machine or storing for an extended period of time.

This procedure is also intended as an anti-freeze measure in the event the machine is exposed to extreme cold temperatures.



## CARE & CLEANING

### CLEANING CYCLE

- CLEAN ME! will be displayed on the LCD to indicate when a cleaning cycle is required (after approx. 200 shots). The cleaning cycle cleans the shower screen and back-flushes the group head.

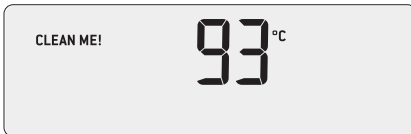

- Insert the supplied grey silicone cleaning disc, followed by 1 cleaning tablet into the filter basket.
- Lock the portafilter into the group head.
- Ensure the water tank is filled with cold water and the drip tray is empty.
- Press the MENU button and rotate SELECT dial until 'CLEAN CYCLE' and 'PUSH' are displayed on the LCD.

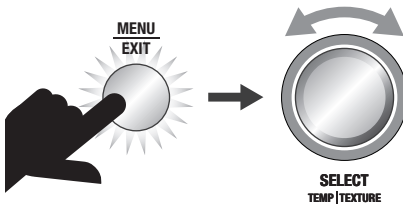

- Press the SELECT dial to start the cleaning cycle.
- The LCD will display a countdown timer showing remaining time for the cleaning cycle in seconds.

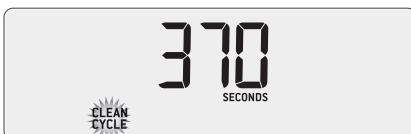

- When the cleaning cycle has finished, remove the portafilter and ensure the tablet has completely dissolved. If the tablet has not dissolved, repeat these steps, without inserting a new tablet.
- Rinse the filter basket and portafilter thoroughly before use.
- Extract an espresso to "season" the machine and purge the system of any remaining cleaner.

### INSTALLING THE WATER FILTER

- Discard the used water filter. Soak a new filter in a cup of water for 5 minutes, then rinse under cold running water.
- Wash the filter holder with cold water.
- Insert the filter into the two parts of the filter holder.
- To install the assembled filter holder into the water tank, align the base of the filter holder with the adapter inside the water tank. Push down to lock into place.
- Fill the water tank with cold water before sliding back into position at the back of the machine and locking into place.
- Replacing the water filter after three months or 40L will reduce the need to descale the machine. The limitation of 40L is based on water hardness level 4. If you are in level 2 area, you can increase this to 60L.

# CARE & CLEANING

## CLEANING CONICAL BURRS

Regular cleaning helps the burrs achieve consistent grinding results which is especially important when grinding for espresso.

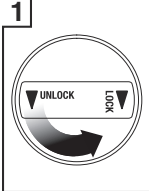
- 

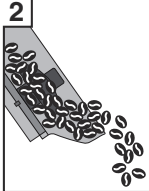
1 Unlock hopper
- 

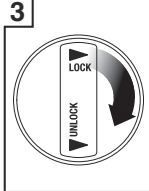
2 Remove beans
- 

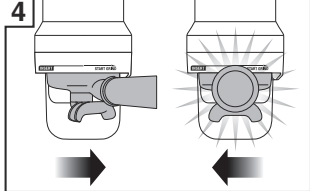
3 Replace & lock hopper
- 

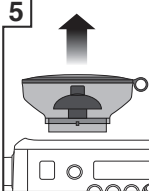
4 Run grinder until empty
- 

5 Unlock & remove hopper
- 

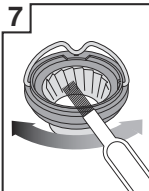
6 Remove upper burr
- 

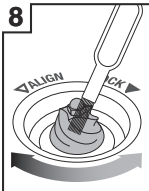
7 Clean upper burr with burr brush
- 

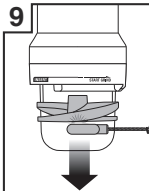
8 Clean lower burr with burr brush
- 

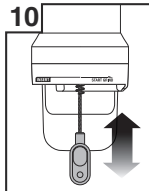
9 Remove tamping fan with tamp removal magnet
- 

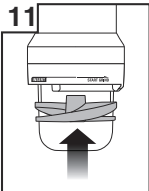
10 Clean grind outlet with grind outlet brush
- 

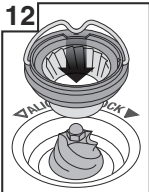
11 Replace tamping fan by hand
- 

12 Push upper burr firmly into position
- 

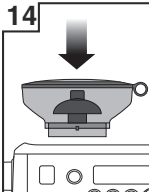
13 Lock upper burr
- 

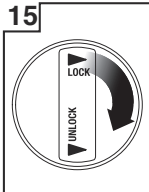
14 Insert hopper
- 

15 Lock hopper

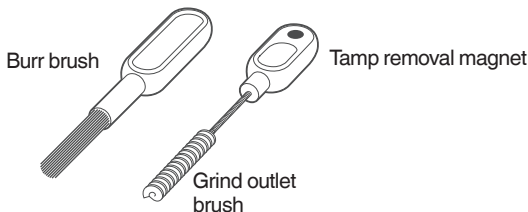

## CARE & CLEANING

### • CLEANING THE STEAM WAND



#### **IMPORTANT**

***After every use, thoroughly wipe the steam wand and tip with a damp cloth & purge immediately. Failure to clean the steam wand may affect the milk texturing performance.***

- If any of the holes in the tip of the steam wand become blocked, ensure the steam lever is in the centre OFF position and unblock using the steam tip cleaning tool. Even partially blocked holes may affect the ability of the steam wand to produce sufficient foam volume.
- If steam wand remains blocked, remove the tip and soak together with steam wand using the provided steam wand cleaning powder (instructions below). Screw tip back onto the steam wand after rinsing.
- The steam wand can be left immersed in the milk jug filled with water when not in use to reduce the risk of blockages.

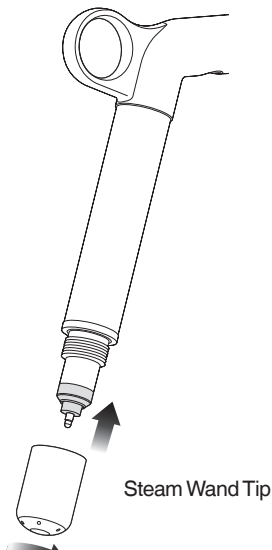

### Steam Wand Cleaning Powder

1. Add 1 packet into an empty milk jug.
2. Add 1 cup (240ml) hot water into milk jug.
3. Remove steam tip and place with steam wand into jug.
4. Leave to soak for 20 minutes.
5. Clean, rinse and replace steam tip. Place wand back into the jug and activate steam for 10 seconds.
6. Allow to soak for 5 minutes.
7. Activate steam several times to purge the steam wand, then rinse the wand thoroughly.
8. Wipe the steam wand dry with a clean cloth.
9. Discard solution & rinse jug thoroughly.

### NOTE

If an alternative cleaning solution is used, please follow the instructions specified.

Please ensure the cleaning solution is food safe and suitable for stainless steel and silicon products.

Please ensure the steam wand tip is tightly fastened after cleaning to avoid temp sensing error.

### CLEANING THE FILTER BASKET AND PORTAFILTER

- The filter basket and portafilter should be rinsed under hot water after each coffee making session to remove all residual coffee oils.
- If the holes in the filter basket become blocked, dissolve a cleaning tablet in hot water and soak filter basket and portafilter in solution for approx. 20 minutes. Rinse thoroughly.

## CARE & CLEANING

### CLEAR WATER BACKFLUSH

- After each coffee making session we recommend doing a clear water backflush before you turn off the machine. Empty drip tray. Insert the cleaning disc into the filter basket then insert the portafilter into the group head. Press the 2 CUP button and allow pressure to build for 20secs, then press to stop and release pressure. Repeat this 5 times to purge any fine coffee grounds and residual coffee oils from the brew water paths.

### CLEANING THE SHOWER SCREEN

- The group head interior and shower screen should be wiped with a damp cloth to remove any ground coffee particles.
- Periodically, run hot water through the group head with the filter basket and portafilter in place, but without ground coffee. This will remove any residual ground coffee particles from the shower screen.

### CLEANING THE DRIP TRAY & STORAGE TRAY

- The drip tray should be removed, emptied and cleaned after each use or when the drip tray indicator is showing Empty Me!
- Remove grill from the drip tray. Wash the drip tray in warm soapy water. The Empty Me! indicator can also be removed from the drip tray.
- The storage tray can be removed and cleaned with a soft, damp cloth (do not use abrasive cleansers, pads or cloths which can scratch the surface).

### CLEANING THE OUTER HOUSING & CUP WARMING TRAY

- The outer housing and cup warming tray can be cleaned with a soft, damp cloth. Polish with a soft, dry cloth. Do not use abrasive cleansers, pads or cloths which can scratch the surface.

#### NOTE

Do not clean any of the parts or accessories in the dishwasher.

# CARE & CLEANING

## DESCALE (dEsc)

### NOTE

Even if you used the provided water filter, we recommend you to descale if there is scale build-up in the water tank.

Only descale via the descale menu.

### 1 – Prepare for Descal

- Empty the drip tray and insert into position.
- Turn the machine off and allow to cool for at least 4 hours. With the machine off, press and hold the 1 CUP button, then press and hold the POWER button together for 3 seconds. rSEt will appear on the LCD.

THEN PRESS  
& HOLD

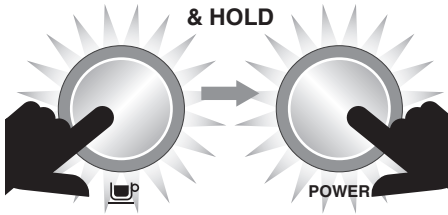

- Rotate SELECT dial until 'dEsc' appears on LCD and press the dial to confirm.

dEsc

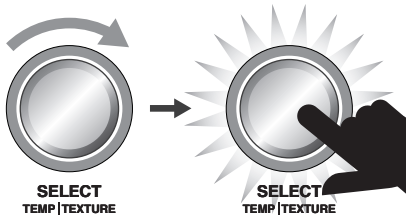

### 2 – Empty Boilers

- Remove the grey silicone cover on the lower front panel marked DESCALE ACCESS.
- 

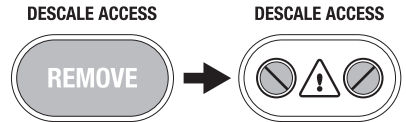

- Place a cloth over the drip tray to prevent steam escaping.

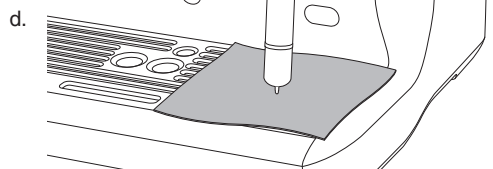

- Use a flat head screw driver to rotate the right valve counter-clockwise SLOWLY until fully open. As the valve opens, steam may be released.

### NOTE

If there's no water released into the drip tray, press and hold the 1 CUP button for 3 seconds. This will release water from the boiler.

When the water is completely empty, close the valve by rotating screws clock-wise until seated. Do not overtighten screws to avoid damages to the valves.

### DESCALE ACCESS



## CARE & CLEANING

- f. Repeat the above process on the left valve.
- g. Empty the drip tray, use caution as the drip tray may be hot.
- h. Empty water tank, remove water filter.
- i. Dissolve 1 sachet of Sage Descaler™ into 1 litre of warm water. Pour solution into the water tank.

### NOTE

If water tank has not been removed, replaced or is empty, "FILL TANK" will appear on the LCD.

### 3 – Begin Descale

- a. Press 1 Cup button and the LCD screen will show countdown time (20 minutes).



During this time, the machine will fill boilers with descale solution and heat to temperature. There may be some water flow through the group head during this time.

Allow the countdown timer to reach 0 as this allows solution sufficient time to dissolve scale build up. However you can proceed to the next step at any time by pressing the 1 Cup button.

- a. Place a cloth over the drip tray to stop steam escaping.
- b. Empty boilers by repeating steps 2c and 2d.
- c. Empty drip tray and insert back to place.
- d. Empty water tank then rinse and fill with clean water to the MAX line. Lock water tank back into position.

### 4 – Flush Boilers

- a. Press 1 Cup button and the LCD screen will show countdown time (20 minutes).



During this time, the machine will fill boilers with fresh clean water and heat to temperature. You can proceed to the next step at any time by pressing the 1 Cup button.

- b. Place a cloth over the drip tray to stop steam escaping.
- c. Empty boilers by repeating steps 2c and 2d.
- d. Empty drip tray and insert back to place.
- e. Empty water tank then rinse and fill with clean water to the MAX line. Lock water tank back into position.

### 5 – Repeat Step 4 Flush Boilers

We recommend flushing boilers again to ensure any residual descale solution is released from the boilers.

Press POWER button to escape the Descale mode. The descale process is now complete and ready to use.

## TROUBLESHOOTING

PROBLEM	POSSIBLE CAUSE	WHAT TO DO
<b>Motor starts but no ground coffee coming from grind outlet</b>	<ul style="list-style-type: none"> <li>No coffee beans in bean hopper.</li> <li>Grinder/bean hopper is blocked.</li> <li>Coffee bean may have become stuck in hopper.</li> </ul>	<ul style="list-style-type: none"> <li>Fill bean hopper with fresh coffee beans.</li> <li>Remove bean hopper. Inspect bean hopper and grinding burrs for blockage. Replace parts and try again.</li> </ul>
<b>Motor starts but operates with a loud 'racket' noise</b>	<ul style="list-style-type: none"> <li>Grinder is blocked with foreign item or chute is blocked.</li> <li>Moisture clogging grinder.</li> </ul>	<ul style="list-style-type: none"> <li>Remove bean hopper, inspect burrs &amp; remove any foreign body.</li> <li>Clean the burrs and grind outlet, see page 18.</li> <li>Leave burrs to dry thoroughly before re-assembling. It is possible to use a hair dryer to blow air into the burr area to quicken the drying process.</li> </ul>
<b>Unable to lock bean hopper into position</b>	<ul style="list-style-type: none"> <li>Coffee beans obstructing bean hopper locking device.</li> </ul>	<ul style="list-style-type: none"> <li>Remove bean hopper. Clear coffee beans from top of burrs. Re-lock bean hopper into position.</li> </ul>
<b>Portafilter overfills</b>	<ul style="list-style-type: none"> <li>Tamping fan was removed for cleaning and not replaced.</li> </ul>	<ul style="list-style-type: none"> <li>Check that the tamping fan is in position and mounted correctly to the drive shaft, page 18.</li> </ul>
<b>Emergency stop?</b>		<ul style="list-style-type: none"> <li>Rotate the portafilter to the left to stop the auto grind, dose &amp; tamp function.</li> <li>Unplug power cord from power outlet.</li> </ul>
<b>There is an alert on the LCD eg. 'OVERHEAT PLEASE WAIT', 'HEATING' etc.</b>		<ul style="list-style-type: none"> <li>See page 15 for list of alerts. If problem persists, contact Sage Customer Service Centre or visit <a href="http://www.sageappliances.com">www.sageappliances.com</a></li> </ul>

## TROUBLESHOOTING

PROBLEM	POSSIBLE CAUSE	WHAT TO DO
<b>Grinder running continuously</b>	<ul style="list-style-type: none"> <li>No beans in hopper.</li> </ul>	<ul style="list-style-type: none"> <li>Fill hopper with beans.</li> <li>Rotate the portafilter to the left to stop the auto grind, dose &amp; tamp function.</li> </ul>
	<ul style="list-style-type: none"> <li>Tamping fan has been removed.</li> </ul>	<ul style="list-style-type: none"> <li>Check that the tamping fan is in position and mounted correctly to the drive shaft, page 18.</li> </ul>
<b>Espresso runs out around the edge of the portafilter</b>  <b>and/or</b>  <b>Portafilter comes out of the group head during an extraction</b>	<ul style="list-style-type: none"> <li>Portafilter not inserted in the group head correctly.</li> </ul>	<ul style="list-style-type: none"> <li>Ensure portafilter is rotated to the right until the handle is past the centre and is securely locked in place. Rotating past the centre will not damage the silicone seal.</li> </ul>
	<ul style="list-style-type: none"> <li>There are coffee grounds around the filter basket rim.</li> </ul>	<ul style="list-style-type: none"> <li>Clean excess coffee from the rim of the filter basket after grinding to ensure a proper seal in group head.</li> </ul>
	<ul style="list-style-type: none"> <li>Filter basket rim is wet or underside of portafilter lugs are wet. Wet surfaces reduce the friction required to hold the portafilter in place whilst under pressure during an extraction.</li> </ul>	<ul style="list-style-type: none"> <li>Always ensure filter basket and portafilter are dried thoroughly before filling with coffee, tamping and inserting into the group head.</li> </ul>
<b>Issues with the Auto Start feature</b>	<ul style="list-style-type: none"> <li>Clock not set or clock is set with incorrect time.</li> </ul>	<ul style="list-style-type: none"> <li>Check that the clock and Auto Start time have been programmed correctly. The LCD will display a clock icon when the Auto Start time is programmed.</li> </ul>
<b>ERR error message on LCD</b>	<ul style="list-style-type: none"> <li>A major fault has occurred and machine cannot operate.</li> </ul>	<ul style="list-style-type: none"> <li>Contact Sage Customer Service Centre or visit <a href="http://www.sageappliances.com">www.sageappliances.com</a></li> </ul>



## TROUBLESHOOTING

PROBLEM	POSSIBLE CAUSE	WHAT TO DO
<b>Pumps continue to operate / Steam is very wet / Hot water outlet leaks</b>	<ul style="list-style-type: none"> <li>Using highly filtered, demineralised or distilled water which is affecting how the machine is designed to function.</li> </ul>	<ul style="list-style-type: none"> <li>We recommend using cold, filtered water. We do not recommend using water with no/low mineral content such as highly filtered, demineralised or distilled water. If the problem persists, contact Sage Customer Service Centre.</li> </ul>
<b>Water does not flow from the group head</b>	<ul style="list-style-type: none"> <li>Machine has not reached operating temperature.</li> </ul>	<ul style="list-style-type: none"> <li>Allow time for the machine to reach operating temperature. The POWER button will stop flashing when machine is ready.</li> </ul>
	<ul style="list-style-type: none"> <li>Water tank is empty.</li> </ul>	<ul style="list-style-type: none"> <li>Fill tank. Prime the system by:               <ol style="list-style-type: none"> <li>1) Pressing 2 CUP button to run water through the group head for 30 seconds.</li> <li>2) Pressing HOT WATER button to run water through the hot water outlet for 30 seconds.</li> </ol> </li> </ul>
	<ul style="list-style-type: none"> <li>Water tank not fully inserted and locked.</li> </ul>	<ul style="list-style-type: none"> <li>Push water tank in fully and lock latch closed.</li> </ul>
<b>FILL TANK on LCD but water tank is full</b>	<ul style="list-style-type: none"> <li>Water tank not fully inserted and locked.</li> </ul>	<ul style="list-style-type: none"> <li>Push water tank in fully and lock latch closed.</li> </ul>
<b>No steam or hot water</b>	<ul style="list-style-type: none"> <li>Machine is not turned on or up to operating temperature.</li> </ul>	<ul style="list-style-type: none"> <li>Ensure the machine is plugged in and the POWER button is illuminated but not flashing.</li> </ul>
<b>No hot water</b>	<ul style="list-style-type: none"> <li>Water tank is empty.</li> </ul>	<ul style="list-style-type: none"> <li>Fill water tank.</li> </ul>
<b>No steam</b>	<ul style="list-style-type: none"> <li>Steam wand is blocked.</li> </ul>	<ul style="list-style-type: none"> <li>Refer to 'Cleaning the Steam Wand', page 19.</li> </ul>

## TROUBLESHOOTING

PROBLEM	POSSIBLE CAUSES	WHAT TO DO
<b>The machine is 'On' but ceases to operate</b>		<ul style="list-style-type: none"> <li>• Turn machine off. Wait for 60 minutes and turn machine back on.</li> <li>• If problem persists, call Sage Customer Service Centre.</li> </ul>
<b>Steam pouring out of group head</b>		<ul style="list-style-type: none"> <li>• Turn machine off. Wait for 60 minutes and turn machine back on.</li> <li>• If problem persists, call Sage Customer Service Centre.</li> </ul>
<b>Espresso only drips from the portafilter spouts, restricted flow</b>	<ul style="list-style-type: none"> <li>• Coffee is ground too finely.</li> </ul>	<ul style="list-style-type: none"> <li>• Adjust the grind size to a higher number to make the grind size slightly coarser.</li> </ul>
<b>Espresso flows out too quickly</b>	<ul style="list-style-type: none"> <li>• The coffee is ground too coarsely.</li> <li>• Coffee beans are stale.</li> </ul>	<ul style="list-style-type: none"> <li>• Adjust the grind size to a lower number to make the grind size slightly finer.</li> <li>• Use freshly roasted coffee beans with a 'Roasted On' date and consume between 5-20 days after that date.</li> </ul>
<b>Coffee not hot enough</b>	<ul style="list-style-type: none"> <li>• Cups not pre-heated.</li> </ul>	<ul style="list-style-type: none"> <li>• Rinse cups under hot water outlet and place on cup warming tray.</li> </ul>
	<ul style="list-style-type: none"> <li>• Milk not hot enough (if making a cappuccino or latté etc).</li> </ul>	<ul style="list-style-type: none"> <li>• Increase the milk temperature. Refer to 'Adjusting Milk Temperature', page 9.</li> </ul>
<b>No crema</b>	<ul style="list-style-type: none"> <li>• Coffee beans are stale.</li> </ul>	<ul style="list-style-type: none"> <li>• Use freshly roasted coffee beans with a 'Roasted On' date and consume between 5-20 days after that date.</li> </ul>

## TROUBLESHOOTING

PROBLEM	POSSIBLE CAUSES	WHAT TO DO
<b>Not enough milk texture</b>	<ul style="list-style-type: none"> <li>• Steam wand is blocked.</li> </ul>	<ul style="list-style-type: none"> <li>• Refer to 'Cleaning the Steam Wand', page 19.</li> </ul>
		<ul style="list-style-type: none"> <li>• Different brands and types of milk and milk alternatives will texture differently. You may need to adjust the texture level accordingly. Refer to 'Adjusting Milk Texture', page 9.</li> </ul>
<b>Too much coffee extracted</b>	<ul style="list-style-type: none"> <li>• Coffee is ground too coarsely.</li> <li>• Shot duration/volume needs to be reprogrammed.</li> </ul>	<ul style="list-style-type: none"> <li>• Adjust the grind size to a lower number to make the grind size slightly finer.</li> <li>• Reprogram the shot duration/volume. Refer to 'Programming Shot Volume/Duration', page 11.</li> </ul>
<b>Not enough coffee extracted</b>	<ul style="list-style-type: none"> <li>• Coffee is ground too finely.</li> <li>• Shot duration/volume needs to be reprogrammed.</li> </ul>	<ul style="list-style-type: none"> <li>• Adjust the grind size to a higher number to make the grind size slightly coarser.</li> <li>• Reprogram the shot duration/volume. Refer to 'Programming Shot Volume/Duration', page 11.</li> </ul>
<b>Amount of coffee extracted has changed, but all settings are the same.</b>	<ul style="list-style-type: none"> <li>• As coffee beans age, the extraction rate changes and can affect the shot volume.</li> </ul>	<ul style="list-style-type: none"> <li>• Adjust the grind size to a lower number to make the grind size slightly finer.</li> <li>• Reprogram the shot duration/volume. Refer to 'Programming Shot Volume/Duration', page 11.</li> <li>• Use freshly roasted coffee beans with a 'Roasted-On' date and consume between 5–20 days after that date.</li> </ul>



**Freephone (UK Landline): 0808 178 1650**  
**Mobile Calls (National Rate): 0333 0142 970**

**[www.sageappliances.co.uk](http://www.sageappliances.co.uk)**  
**[customerservice@sageappliances.co.uk](mailto:customerservice@sageappliances.co.uk)**

### **Register your product and get more from your purchase**

Product registration takes only a few minutes and ensures a record of your purchase. Registration also makes it easier to get support and advice on any questions or issues that you might have in the future. If you wish, we can also send you free recipes and additional hints and tips on making the best of your appliance.

➤ Go to [www.sageappliances.co.uk](http://www.sageappliances.co.uk) and click on 'Product Registration.'

### **What's on your mind?**

Our constant aim is to improve the quality and features of our appliances. We welcome your comments and ideas in assisting our ongoing development.

➤ Go to [www.sageappliances.co.uk](http://www.sageappliances.co.uk) and click on 'Support.'



Registered in England & Wales No. 8223512. Due to continued product improvement, the products illustrated or photographed in this document may vary slightly from the actual product.

Copyright BRG Appliances 2017.

SES980