



J10 (EA/SA/INTA)

Instructions for use



Additional online content

Tap, click or scan the QR code to access additional online resources.

There are video tutorials to help you operate your J10.



jura.com/support-j10

Specialities of your J10

Espresso 			Cappuccino S
Coffee 		S	Sweet Latte
Americano 			Lungo
Flat White 			Latte macchiato S
Cortado 			Caffè latte S
1 portion milk foam S			1 portion milk S
Espresso doppio 			Americano
Hot water			Hot water for green tea

Possible preselections (Speciality Selection):

- Sweet Foam
- Cold Brew
- Extra Shot
- Ground coffee
- Double product

i For many specialities, you can combine **two preselections**, e.g. 'Cold Sweet latte macchiato'.

Your J10

Specialities of your J10	2
1 Control elements	4
2 For your safety	5
Comply with the instructions for use.....	5
Proper use	5
User limitations	5
Use by children.....	5
What to do in the event of damage.....	5
Preventing damage.....	6
Danger of electric shock	6
Danger of burns, scalding and injury.....	6
3 Preparing and using for the first time	7
Setting up the machine.....	7
Filling the bean container.....	7
Determining the water hardness	7
First-time use.....	7
Managing your J10 – the JURA Cockpit	9
Connecting milk.....	9
Establish Wi-Fi connection.....	10
4 Preparation	10
Preparation with preselection (Speciality Selection).....	10
Espresso and coffee.....	11
Sweet latte (prepared with syrup attachment).....	11
Cold Brew	12
Latte macchiato, cappuccino and other speciality coffees with milk.....	13
Milk and milk foam.....	13
Americano and lungo	13
Espresso doppio.....	13
Ground coffee.....	13
Hot water.....	14
Adjusting the product settings.....	15
5 Daily operation	15
Switching the machine on and off.....	15
Filling the water tank.....	16
Maintenance actions	16
6 Machine settings	17
7 Maintenance	17
Rinsing the machine.....	18
Rinsing the milk system	18
Cleaning the milk system.....	19
Dismantling and rinsing the professional fine foam frother	19
Inserting/changing the filter	20
Cleaning the machine.....	21
Descaling the machine	22
Descaling the water tank.....	23
Cleaning the bean container.....	23
8 Display messages	24
9 Troubleshooting	24
10 Transport and environmentally friendly disposal	25
Transport / Emptying the system	25
Disposal	25
11 Technical data	26
12 Index	26
13 JURA contact details / Legal information	28

1 Control elements

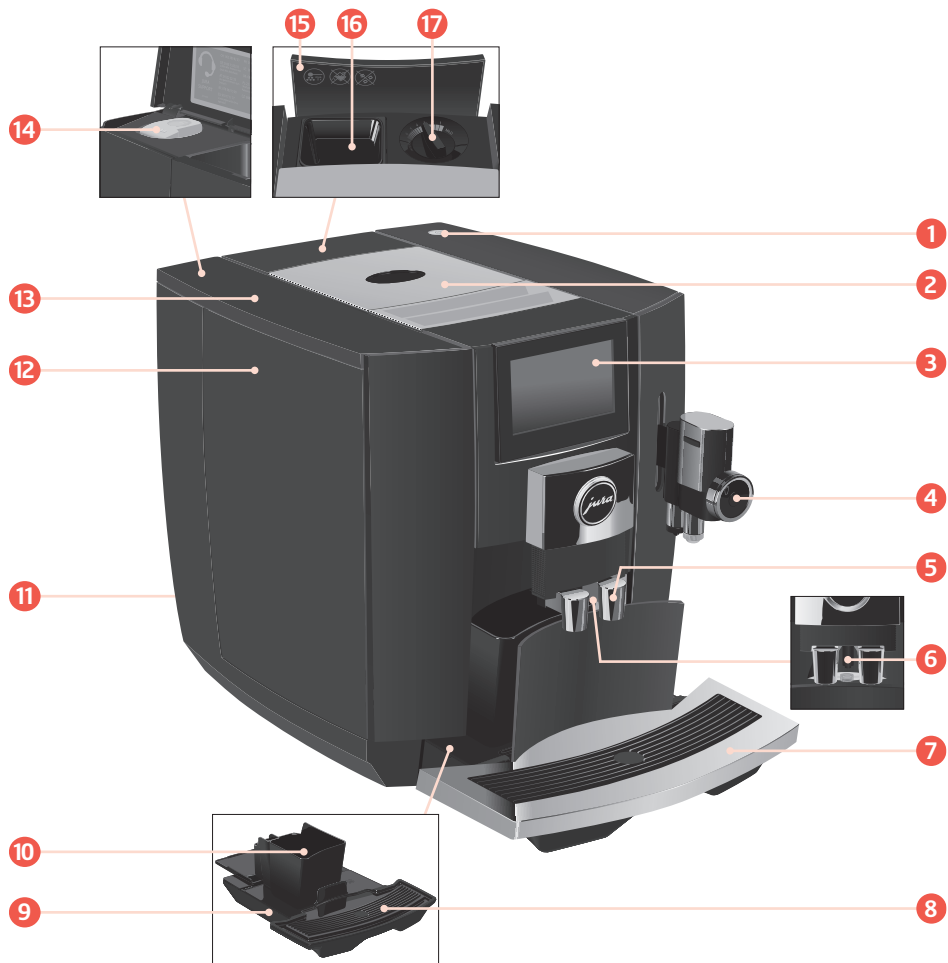

- 1 On/Off button
- 2 Bean container with aroma preservation cover
- 3 Touch display
- 4 Milk system with professional fine foam frother (height-adjustable)
- 5 Height-adjustable coffee spout
- 6 Hot-water spout
- 7 Cup grille with aperture
- 8 Insert for drip tray
- 9 Drip tray
- 10 Coffee grounds container
- 11 Mains cable (permanently connected or plug-in)
- 12 Water tank
- 13 Water tank cover
- 14 Service socket with JURA Wi-Fi Connect (under cover)
- 15 Filler funnel cover
- 16 Filler funnel for ground coffee (removable)
- 17 Grinder adjustment switch
- 18 Container for milk system cleaning
- 19 Measuring spoon for ground coffee
- 20 Syrup attachment





2 For your safety

Comply with the instructions for use

Before using the machine, read these instructions for use thoroughly and completely and comply with the instructions they contain. Keep these instructions for use close to the machine and pass them on to the next user.

Failure to observe the instructions for use may result in serious injuries or damage to property. Safety information is therefore indicated as follows:

 WARNING	Indicates circumstances that may result in serious injuries or death.
 CAUTION	Indicates circumstances that may result in minor injuries.
CAUTION	Indicates circumstances that may result in damage to property.

Proper use

The machine is intended for private domestic use. It should only be used for coffee preparation and to heat milk and water. Use for any other purpose will be deemed improper.

User limitations

People, including children, who

- do not have the physical, sensory or mental capabilities to use the machine safely or
- are inexperienced or lack knowledge

must be supervised by a responsible person when using it, or must be instructed in how to use it correctly.

When using the CLARIS Smart+ filter cartridge or a JURA Wi-Fi Connect, wireless connections are established. Specific details on the frequency band used and the maximum transmission power can be found in the '11 Technical data' section.

Use by children

Children must be able to recognise and understand the potential dangers arising from incorrect use:

- Keep **children under the age of 8** away from the machine, or supervise them constantly.
- **Children aged 8 and over** may only operate the machine without supervision if they have been instructed in how to use it safely.
- Children may not clean or service the machine unless supervised by a responsible person.
- Do not allow children to play with the machine.

What to do in the event of damage

Never use a damaged machine or mains cable. This could result in fatal electric shock.

- In the event of signs of damage, disconnect the machine from the mains. To do this, first switch the J10 off with the On/Off button . Only then should you remove the mains plug from the power socket.
- Replace a damaged **plug-in mains cable** with an original JURA mains cable. Unsuitable mains cables may result in consequential damage.
- Only permit authorised JURA service centres to carry out **repairs to the machine** and the **permanently connected mains cable**. Unsuitable repairs may result in consequential damage.

Preventing damage

To avoid damage to the machine and the mains cable:

- The J10 must not be placed in a cabinet when in use.
- Do not use the J10 and the mains cable near hot surfaces.
- Do not allow the mains cable to rub against sharp edges and ensure that it does not become trapped.
- Never allow the mains cable to loosely hang down. The mains cable could pose a tripping hazard or become damaged.
- Protect the J10 from weather and direct sunlight.
- Only connect the J10 to a mains voltage corresponding to that stated on the rating plate. The rating plate is located on the underside.
- Connect the J10 directly to a domestic power socket. Using multi-socket adapters or extension cords may cause overheating.
- The surface of the heating element and outer enclosure remains hot after use and the outside of the appliance may retain heat.
- Do not use alkaline or alcohol-based cleaning agents; only use mild cleaning agents and a soft cloth.
- Do not use any coffee beans treated with additives or caramelised coffee beans.
- Only fill the water tank with fresh, cold, non-carbonated water.
- Switch the machine off with the On/Off button  if you are going to be absent for a longer period of time and remove the mains plug from the power socket.
- Only use original JURA maintenance products. Use of products that are not explicitly recommended by JURA could damage your J10.

Danger of electric shock

Water conducts electricity. Do not bring water and electricity into contact with one another:

- Never touch the mains plug with wet hands.
- Do not immerse the J10 and/or mains cable in water.
- Do not put the J10 or any individual parts in the dishwasher.
- Before cleaning, switch the J10 off with the On/Off button . Always wipe the J10 with a damp cloth rather than a wet one, and protect it from prolonged exposure to water splash. The J10 must not be cleaned with a jet of water.
- The J10 is not suitable for installation on a surface where a jet of water can be used.

Danger of burns, scalding and injury

- Do not touch the spouts during operation. Use the handles provided.
- Optionally, your J10 can be remotely operated using mobile devices. When preparing a product or initiating a maintenance programme, make sure that other people are not put at risk – for example, through contact with the spouts.
- Be careful to ensure that the fine foam frother is correctly installed and clean, otherwise the fine foam frother (or parts of it) may come loose.

3 Preparing and using for the first time

Setting up the machine

- ▶ Choose a spot for your J10 which protects the machine against overheating. Ensure that the ventilation slots are not covered.

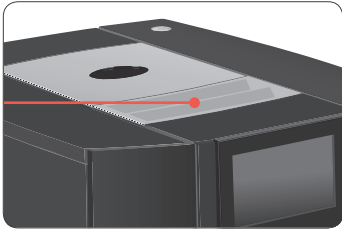

- ▶ Place the J10 on a horizontal surface that is not sensitive to water.

Filling the bean container

The aroma preservation cover on the bean container ensures that the aroma of the beans is retained for longer.

CAUTION

Coffee beans which have been treated with additives (e.g. sugar), ground coffee or freeze-dried coffee will damage the grinder.

- ▶ Only use roasted, untreated coffee beans to fill the bean container.
- ▶ Remove the aroma preservation cover.
- ▶ Fill the bean container with coffee beans and close the aroma preservation cover.

Determining the water hardness

When you use the machine for the first time, you must set the water hardness. If you know the hardness of your water, go straight to the next section. If you do not know the water hardness, you can find this out first:

- ▶ Hold the Aquadur® test strip supplied under running water for one second. Shake off the water.
- ▶ Wait for about 1 minute.
- ▶ You will then be able to read the degree of water hardness from the discolouration of the Aquadur® test strip and the description on the packaging.

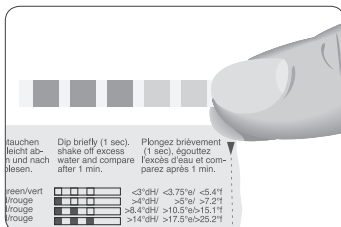

First-time use

⚠ WARNING

If the machine is operated with a defective mains cable, there is a danger of potentially fatal electric shock.

- ▶ Never use a machine which is damaged or has a defective mains cable.

CAUTION

Milk, sparkling mineral water or other liquids can damage the water tank or the machine.

- ▶ Only fill the water tank with fresh, cold water.

Precondition: The bean container has been filled.

- ▶ For machines with a **plug-in** mains cable: Connect the mains cable to the machine.
- ▶ Insert the mains plug into a power socket.
- ▶ Press the On/Off button  to switch the J10 on.

'Sprachauswahl' / 'Deutsch'

- ▶ To display more languages, touch < or > until the desired language comes into focus (e.g. 'English').

3 Preparing and using for the first time

- ▶ Touch 'Save'.
'Saved' appears briefly on the display.
'Water hardness'

i Please refer to the section above for a description of how to determine the water hardness.

- ▶ Touch < or > to change the water hardness setting.
- ▶ Touch 'Save'.
'Saved' appears briefly on the display.
'Insert filter'
- ▶ Place a receptacle under the coffee spout.



- ▶ Remove the water tank and rinse it with cold water.
- ▶ Fit the filter cartridge extension supplied on top of the CLARIS Smart+ filter cartridge.



- ▶ Insert the filter cartridge with its extension into the water tank.
- ▶ Turn the filter cartridge clockwise until it audibly clicks into place.

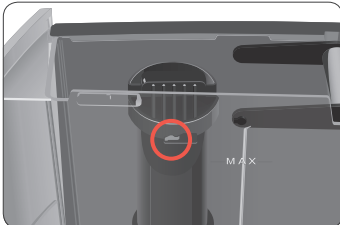

- ▶ Fill the water tank with fresh, cold water and reinsert the tank.

i The machine automatically detects that you have just inserted the filter cartridge.

'Filter is being rinsed', water flows directly into the drip tray.

'System is filling'

'Empty drip tray'

- ▶ Empty the drip tray and put it back into the machine.



'Accessory'

i You have the option of connecting the J10 to the JURA Cool Control milk cooler (wireless connection). To do this, touch 'Connect' and follow the instructions on the display.

- ▶ Touch 'Next'.
'Wi-Fi connection'

- ▶ If necessary, scan the QR code with your mobile device to download the JURA app (J.O.E.®).



- i** If you would like to connect the J10 to your home network, touch '**Connect**' and follow the instructions on the display. You can also establish the connection later on (in the machine settings under '**Wi-Fi connection**').

- ▶ Place one receptacle under the coffee spout and another under the fine foam frother.



- ▶ Touch '**Next**'.
'Machine is rinsing', 'Milk system is being rinsed'
The start screen is displayed. Your J10 is ready for use.

Managing your J10 – the JURA Cockpit

The **JURA Cockpit** allows you to manage your J10. To go to the JURA Cockpit, swipe your finger across the start screen from bottom to top.

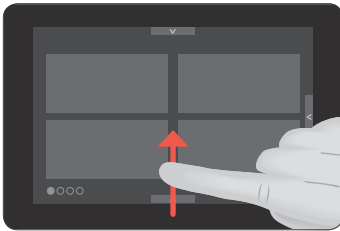

Symbol	Meaning
	'Maintenance' area (blue)
	'Machine settings' area (green)
(white)	Your J10 is connected to the network and/or Cool Control via JURA Wi-Fi Connect
(red)	No connection to the Wi-Fi network
	Filter mode
	The 'Coffee Eye' function (for cup detection) is enabled

Connecting milk

Your J10 creates fine, creamy, feather-light milk foam with a perfect consistency. The most important requirement for frothing milk is a milk temperature of 4–8 °C. We would therefore recommend using a milk cooler or a milk container.

- ▶ Remove the protective cover from the fine foam frother.
- ▶ Connect the milk pipe to the fine foam frother.

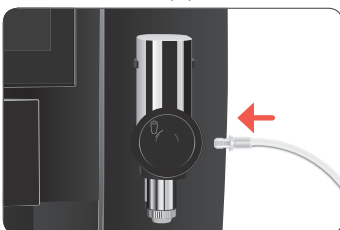

4 Preparation

i The milk system of your J10 has a connector **HP3** and an interchangeable milk spout **CX3**.

- ▶ Connect the other end of the milk pipe to a milk container or a milk cooler.

Establish Wi-Fi connection

Your J10 can be connected with J.O.E.®, your JURA app.

Precondition: J.O.E.® is installed on your mobile device. The JURA Wi-Fi Connect is inserted into the service socket of your J10.

- ▶ To go to the JURA Cockpit, swipe your finger across the start screen from bottom to top.

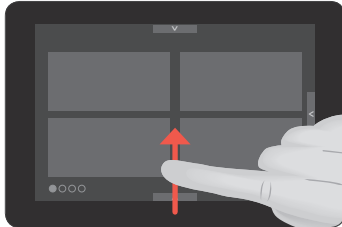

- ▶ Touch the 'Machine setting'  symbol.
- ▶ Touch 'Wi-Fi connection'.
- ▶ Touch 'Connect'.
- ▶ Add a new network in your JURA app (J.O.E.®) and follow the instructions.

4 Preparation

Basic information about preparing drinks:

Aim	What to do
Display more products	Touch  to display additional pages of the start screen or swipe across the start screen from right to left to open the product selector view
Change the coffee strength of a single product	While the grinder is operating, swipe across the coffee beans on the display with your finger
Change the amount for a single product	During preparation, touch < or >
Permanently change the coffee strength, quantity and temperature for any given product	Touch and hold a product for around 2 seconds and configure the settings under 'Product settings'
Changing the consistency of grind	Turn the grinder adjustment switch to the desired position
Stop preparation	Touch 'Cancel'
Place a product on the start screen as a favourite	Touch and hold a product for around 2 seconds and then touch 'Replace'

i If the screensaver is active, touch the display to return to the start screen.

i Coffee tastes best served hot. A cold porcelain cup cools the beverage – and impairs the taste. We therefore recommend prewarming the cups. You can purchase a JURA cup warmer from your specialised dealer.

Preparation with preselection (Speciality Selection)

Swipe across the display from top to bottom to open the Speciality Selection.

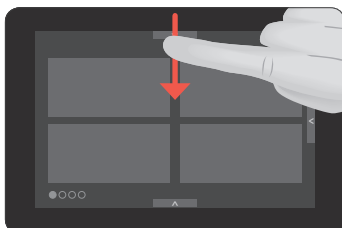

Now choose the desired preselection for the product:

Speciality Selection	Meaning
 – 'Cold Brew' (all speciality coffees except for espresso doppio)	The product is prepared using the Cold Extraction Process, which involves extraction with cold water pulsed at high pressure.

Speciality Selection	Meaning
☑ – ‘Extra Shot’ (all speciality coffees with milk except for macchiato and cortado)	The product is prepared with two brewing operations, with half the amount of water – for a speciality coffee with a particularly intense taste.
☑☑ – Double product (espresso, coffee)	The product is prepared with two brewing operations (two strokes).
☑ – Ground coffee (all speciality coffees except for espresso doppio)	The product is prepared with ground coffee.
‘S’ – ‘Sweet Foam’ (all specialities with milk)	Use the syrup attachment provided to prepare the product with sweet milk foam. The preselection ‘S’ can also be used in combination with other preselections.

i The Speciality Selection closes after 10 seconds.

Espresso and coffee

Example: Coffee

- ▶ Place a cup under the coffee spout.



- ▶ Touch ‘Coffee’.
The preset amount of water for coffee flows into the cup.

Sweet latte (prepared with syrup attachment)

The Sweet Latte is a speciality coffee with sweet milk foam. To make this speciality, use the syrup attachment provided.

- i** All specialities with milk can also be prepared with **sweet milk foam**. To do this, use the syrup attachment provided and before starting preparation, select the Speciality Selection ‘S’.

Precondition: Milk is connected to the fine foam frother.

- ▶ Remove the cover from the syrup attachment.



- ▶ Fill the syrup attachment with syrup. Fill it to the first, second or third mark depending on the desired sweetness.
- ▶ Close the syrup attachment.
- ▶ Tap ‘Sweet Latte’.
‘Please connect the syrup attachment, ensuring it is filled with syrup’
- ▶ Remove the lower part of the fine foam frother.



4 Preparation

- ▶ Connect the syrup attachment to the fine foam frother.



- ▶ Turn the setting wheel of the fine foam frother to the 'Milk Foam' position.
- ▶ Place a cup under the fine foam frother.
- ▶ Touch 'Next'.
The preset amounts of coffee and milk foam flow into the cup.
'Please remove the syrup attachment for cleaning and connect the fine foam frother.'
- ▶ Remove the syrup attachment and rinse it thoroughly under running water.
- ▶ Touch 'Next'.

i 8 minutes after preparation, the milk system is **automatically** rinsed. Therefore always place a receptacle under the fine foam frother after preparing milk.

To ensure that the fine foam frother always works properly, you must clean it **daily** when you have been preparing milk (see chapter 7 'Maintenance – Cleaning the milk system').

Cold Brew

The 'Cold Brew' preselection ☼ is used to prepare a cold speciality coffee.

Example: Cold Brew coffee

- ▶ Fill the water tank with **cold** water.

i The temperature of the water in the water tank affects the brewing result. Use fresh, cold water.

- ▶ Add ice cubes to a glass according to your own preferences.
- ▶ Place the glass under the coffee spout.



- ▶ Swipe across the display from top to bottom to open the Speciality Selection.

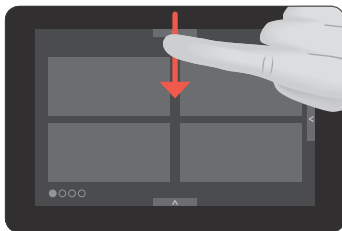

- ▶ Touch ☼ to activate the 'Cold Brew' preselection.
- ▶ Tap 'Coffee'.

i A Cold Brew speciality coffee can only be prepared using a **mild** grind consistency setting. If the grinder adjustment switch is set to 'INTENSE', you will be asked to change it to 'MILD' using the grinder adjustment switch.

The preset amount of water for the coffee flows into the glass.

Latte macchiato, cappuccino and other speciality coffees with milk

Your J10 prepares the following speciality coffees with milk at the touch of a button:

- Latte macchiato
- Cappuccino
- Cortado
- Flat white
- Café au lait
- Macchiato

Example: Latte macchiato

Precondition: Milk is connected to the fine foam frother.

- Place a glass under the fine foam frother.



- Turn the setting wheel of the fine foam frother to the 'Milk Foam' position.
 - Touch 'Latte macchiato'.
- The preset amount of milk foam flows into the glass.

i There is a short interval while the hot milk separates from the milk foam. This allows the typical layers of a latte macchiato to form.

The preset amount of water for espresso flows into the glass.

i **8 minutes** after preparation, the milk system is **automatically** rinsed. Therefore always place a receptacle under the fine foam frother after preparing milk.

To ensure that the fine foam frother always works properly, you must clean it **daily** when you have been preparing milk (see chapter 7 'Maintenance – Cleaning the milk system').

Milk and milk foam

Your J10 prepares hot milk and milk foam. To do this, turn the setting wheel of the fine foam frother to the 'Milk Foam' or 'Milk' position.

i **8 minutes** after preparation, the milk system is **automatically** rinsed. Therefore always place a receptacle under the fine foam frother after preparing milk.

Americano and lungo

For the americano and lungo, the J10 blends the coffee with hot water using a special preparation method. This results in a full-bodied speciality coffee which is particularly easy to digest. You can change the amount of this additional water (see chapter 4 'Preparation – Adjusting the product settings').

Espresso doppio

'Doppio' is Italian for 'double'. When you select Espresso doppio, two espressi are prepared one after the other. The result is an extra full-bodied and aromatic speciality coffee.

Ground coffee

You can choose to use a second coffee variety, for example decaffeinated coffee, with the filter funnel for ground coffee.

- Never add more than two level measuring spoons of ground coffee.
- Use ground coffee which is not ground too finely. Very fine coffee can block up the system so that the coffee only comes out in drips.
- If you did not fill the machine with a sufficient amount of ground coffee, 'Not enough ground coffee' is displayed and the J10 stops the operation.
- The desired speciality coffee must be prepared within approximately one minute after filling with the ground coffee. Otherwise the J10 stops the operation and is once more ready for use.

4 Preparation

Example: Proceed as follows to prepare one espresso using ground coffee.

- Place an espresso cup under the coffee spout.
- Swipe across the display from top to bottom to open the Speciality Selection.

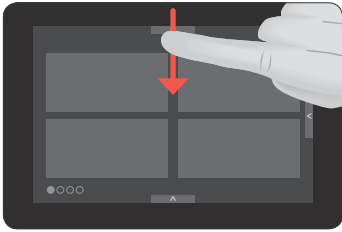

- Touch .
- Touch 'Espresso'.
'Please add ground coffee'
- Open the cover of the filler funnel for ground coffee.



- Add the desired amount of ground coffee to the filler funnel (max. 2 level measuring spoons).

i The amount of ground coffee determines the intensity and aroma of the beverage, so you can adjust it to your personal preferences.

- Close the cover of the filler funnel.
- Touch 'Next'.
The preset amount of water for espresso flows into the cup.

Hot water

The J10 allows you to prepare different variants of hot water:

- 'Hot water'
- 'Hot water for green tea'

⚠ CAUTION

There is a danger of scalding from hot water splashes.

- Avoid direct contact with the skin.
-

Example: Hot water

- Place a cup under the hot-water spout.



- Touch 'Hot water'.
The preset amount of water flows into the cup.

Adjusting the product settings

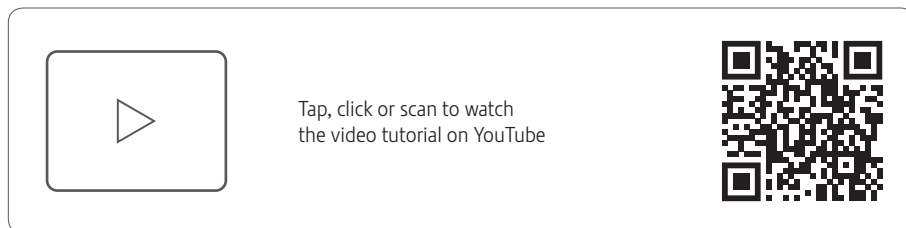



Touch and hold a product for **approximately 2 seconds** to access the settings:

- **'Product settings'**: Specify individual settings such as coffee strength, amount of water, etc.
- **'Product name'**: Change the name of the product.
- **'Permanent preselection'**: Specify a permanent preselection (Speciality Selection).
- **'Product position'**: Replace the products on the start screen with your favourites.

Example: Proceed as follows to change the coffee strength for one coffee.

- Touch and hold **'Coffee'** for **approximately 2 seconds**.
- Touch **'Product settings'**.

i Depending on the selected product, different settings will be available which are represented by symbols on your display.

- Touch the  symbol.
The  symbol appears in white.
- Swipe across the coffee beans with your finger to change the coffee strength setting.
- Touch **'Save'**.
- Touch **'Back'** to return to the start screen.

5 Daily operation

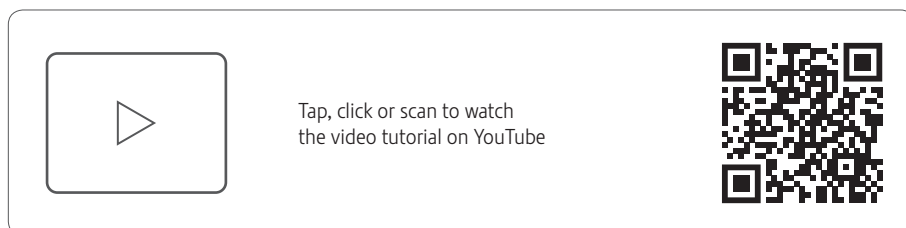

Switching the machine on and off

- Place one receptacle under the coffee spout and another under the fine foam frother.



- Press the On/Off button .
- 'Machine is rinsing'**
- Your J10 is switched on or off.

i When the machine is switched off, the system is only rinsed if a speciality coffee has been prepared.

i If milk has been prepared before switching off, you will be prompted to carry out milk system cleaning (**'Clean the milk system'**). After 30 seconds the switch-off process continues automatically.

Filling the water tank

Daily maintenance of the machine and hygiene when handling coffee and water are key to a perfect coffee result in the cup every time. You should therefore change the water **daily**.

CAUTION

Milk, sparkling mineral water or other liquids can damage the water tank or the machine.

- Only fill the water tank with fresh, cold water.
- Remove the water tank and rinse it with cold water.
- Fill the water tank with fresh, cold water and reinsert the tank.

Maintenance actions

Optimal coffee quality depends on many factors. One important prerequisite is regular maintenance of your J10. Carry out the following steps:

Maintenance action	Daily	If necessary	Note
Empty the drip tray and coffee grounds container and rinse with warm water (The insert for the drip tray, including the drip tray itself, and the coffee grounds container are dishwasher-safe)	▪		Always empty the coffee grounds container when the machine is switched on. This is the only way of resetting the coffee grounds counter.
Clean the milk system (if heavily soiled, also dismantle and rinse it)		▪	See chapter 7 'Maintenance – Cleaning the milk system'. We recommend dismantling and rinsing the dual spout once a week (see chapter 7 'Maintenance – Dismantling and rinsing the professional fine foam frother').
Rinse the milk pipe	▪		
Rinse the water tank	▪		
Wipe the surface of the machine with a clean, soft, damp cloth (e.g. microfibre cloth)	▪		
Remove and clean the powder chute for ground coffee		▪	
Changing milk pipe with connector HP3		approx. every 3 months	
Change the interchangeable milk spout CX3		approx. every 3 months	
Clean the inside of the water tank with a brush		▪	
Clean the top and bottom of the cup grille		▪	
Thoroughly clean the drip tray and coffee grounds container		▪	In the 'Maintenance' area  of the Cockpit, the message 'Maintenance information' appears.

- i** You will find more information about the maintenance of your J10 in the 'Maintenance' area  in the programme item 'Maintenance information'.

6 Machine settings

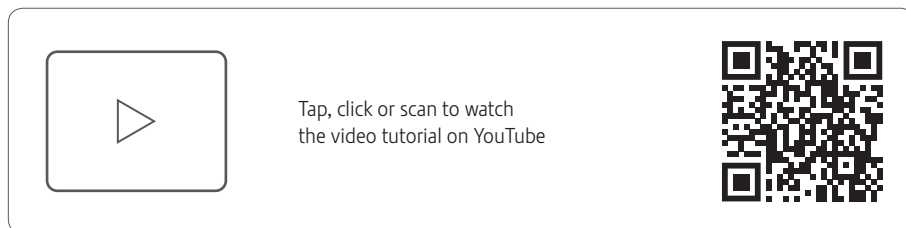

To go to the JURA Cockpit, swipe your finger across the start screen from bottom to top.

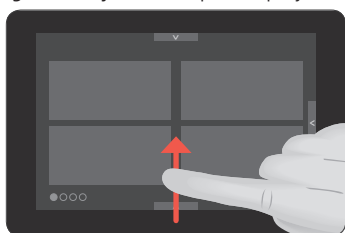



In the 'Machine settings' section , the following settings can be saved (tap on '1/3' at the top right to navigate through the individual pages):

Programme item	Explanation
Page '1/3'	
'Coffee Eye'	Enable/disable automatic cup detection with the 'Coffee Eye'
'Product name'	Display product images with/without product names on the start screen
'Number of start screens'	Define number of start screens (1–5)
'Number of products'	Set the number of products on the start screen: 2 products / 5 products
'Wi-Fi connection'	Wirelessly connect the J10 to the JURA app (J.O.E.®) or disconnect again (see chapter 3 'Preparing and using for the first time – Establish Wi-Fi connection')
'Switch off after'	Set the automatic switch-off time to save energy (switch-off after 15 minutes, 30 minutes or 1 – 9 hours after the last action on the machine)
'Choose language'	Set language
'Factory setting'	Reset your J10 to factory settings (the machine then switches off)
'Water hardness'	Set the hardness of the water used (1 °dH to 30 °dH) to prevent limescale building up in your machine
Page '2/3'	
'Units'	Set the unit for the amount of water (ml or oz)
'Accessory'	Establish a wireless connection between your J10 and the Cool Control milk cooler or disconnect it again
'Display'	Change display brightness (in 10% increments)
'Product counter'	View product counter
'Maintenance counter'	View the maintenance counter
'Operating instructions'	Show instructions for using the syrup attachment and fine foam frother and switching between milk and milk foam
'Aroma control'	Show recommended settings for consistency of grind (enabled/disabled)
'Rinse the milk system'	Set whether milk system rinsing takes place automatically or needs to be started manually
Page '3/3'	
'Empty system'	Empty the system to protect the J10 from frost damage during transport
'Information'	View software version

7 Maintenance

Basic information about maintenance:

- To go to the JURA Cockpit, swipe your finger across the start screen from bottom to top. This area consists of a 'Maintenance status'  section and a 'Machine setting'  section. You can manage the maintenance of your J10 in the  section.
- The Cockpit shows maintenance programmes that need to be carried out in the form of messages with red backgrounds. Touch a message to go straight to the corresponding maintenance programme. Maintenance programmes that are due imminently are indicated on your J10 by means of a bar display within the message.
- Carry out each maintenance programme when you are prompted to do so.

Rinsing the machine

You can start coffee system rinsing manually at any time.

Precondition: The start screen is displayed.

- Place one receptacle under the coffee spout and another under the fine foam frother.



- To go to the JURA Cockpit, swipe the start screen from bottom to top.

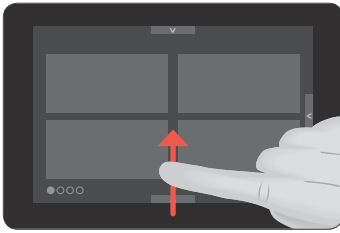

- Touch the 'Maintenance' symbol .
- Touch 'Rinse the coffee system' to start the rinse operation.
'Machine is rinsing'
The rinse stops automatically. The start screen is displayed.

Rinsing the milk system

After each milk preparation, the J10 prompts you to perform a milk system rinse.

In the machine settings you can define whether milk system rinsing takes place automatically or needs to be started manually (see chapter 6 'Machine settings').

Precondition: The start screen is displayed..

- Place a receptacle under the fine foam frother.



- To go to the JURA Cockpit, swipe across the start screen from bottom to top.

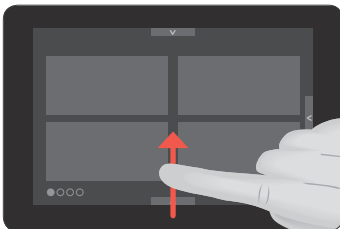

- Touch the 'Maintenance' symbol .
- Press the 'Rinse the milk system' button to start the rinse operation.
'Milk system is being rinsed'
The rinse stops automatically. The start screen is displayed.

Cleaning the milk system

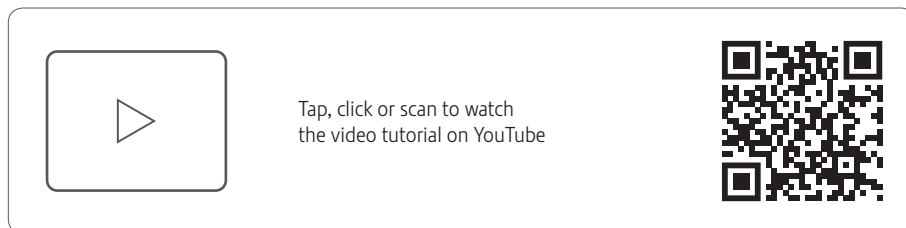

To ensure that the milk system always works properly, you must clean it **daily** when you have been preparing milk.

CAUTION

If the wrong cleaning agent is used, the machine could be damaged and/or traces could be left behind in the water.

- ▶ Use only original JURA maintenance products.

i JURA milk system cleaner is available from specialised dealers.

i Use the container supplied for milk system cleaning.

Precondition: 'Clean the milk system' is displayed in the Cockpit.

- ▶ Tap 'Clean the milk system'.
- ▶ Touch 'Next'.
- ▶ 'Cleaning agent for milk system' / 'Connect the milk tube'
- ▶ Remove the milk pipe from the milk container or milk cooler.
- ▶ Pour one dosing unit of milk system cleaner into the container for milk system cleaning.



- ▶ Place the container under the coffee spout and the fine foam frother.
- ▶ Connect the milk pipe to the container.



i To connect the milk pipe to the container correctly, the pipe must be fitted with a connector HP3.

- ▶ Touch 'Start'.
- ▶ The fine foam frother and the milk pipe are cleaned.
- ▶ The operation stops automatically.

Dismantling and rinsing the professional fine foam frother

If insufficient foam is produced when the milk is frothed or milk sprays out of the professional fine foam frother, the frother may be dirty. If this happens, dismantle and rinse the professional fine foam frother.

i We recommend that you dismantle and rinse the professional fine foam frother once a week

7 Maintenance

- ▶ Remove the milk pipe and rinse it thoroughly under running water.
- ▶ Remove the professional fine foam frother.

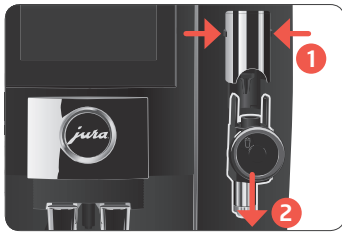

- ▶ Dismantle the fine foam frother into its individual parts.

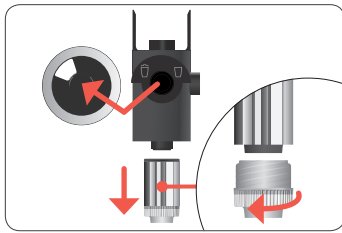

- ▶ Rinse all the parts under running water. If there are severely dried-on milk residues, firstly immerse the individual parts in a solution of 250 ml water and one dosing unit of JURA milk system cleaner. Then rinse the individual parts thoroughly.
- ▶ Re-assemble the professional fine foam frother.

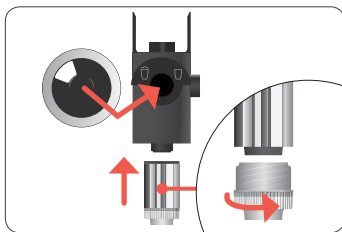

- i** Ensure that all individual parts are correctly and firmly connected to ensure optimum operation of the professional fine foam frother.
- ▶ Re-fit the professional fine foam frother on the milk system.



Inserting/changing the filter

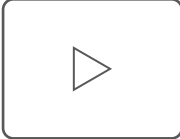

Tap, click or scan to watch
the video tutorial on YouTube



Once the filter cartridge stops working (depending on the water hardness setting), the J10 will prompt you to change the filter.

- i** Your J10 no longer has to be descaled if you are using the CLARIS Smart+ filter cartridge.
- i** CLARIS Smart+ filter cartridges are available from specialised dealers.

Precondition: 'Change the filter' is displayed in the Cockpit.

- ▶ Remove and empty the water tank.
- ▶ Turn the filter cartridge anticlockwise and remove it along with the extension from the water tank.
- ▶ Remove the used filter cartridge.

- ▶ Fit the filter cartridge extension on top of a **new** CLARIS Smart+ filter cartridge.



- ▶ Insert the filter cartridge with its extension into the water tank.
- ▶ Turn the filter cartridge clockwise until it audibly clicks into place.



- ▶ Fill the water tank with fresh, cold water and reinsert the tank. The machine automatically detects that you have just inserted/changed the filter cartridge. 'Filter is being rinsed', water flows directly into the drip tray. 'Empty drip tray'
- ▶ Empty the drip tray and coffee grounds container and put them back into the machine.

Cleaning the machine

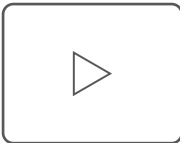

Tap, click or scan to watch
the video tutorial on YouTube



After 180 preparations or 80 switch-on rinses, the J10 will prompt you to clean it.

CAUTION

If the wrong cleaning agent is used, the machine could be damaged and/or traces could be left behind in the water.

- ▶ Use only original JURA maintenance products.

- i** The cleaning programme lasts approximately 20 minutes.
- i** JURA cleaning tablets are available from specialised dealers.

Precondition: 'Clean' is displayed in the Cockpit.

- ▶ Fill the water tank.
- ▶ Tap 'Clean'.
- ▶ Touch 'Start'.
- ▶ 'Empty coffee grounds container' / 'Empty drip tray'
- ▶ Empty the drip tray and coffee grounds container and put them back into the machine.
- ▶ Place one receptacle under the coffee spout and another under the fine foam frother.



7 Maintenance

- ▶ Touch 'Next'.
'Machine is being cleaned'
The operation is interrupted, 'Add cleaning tablet'.
- ▶ Open the cover of the filler funnel for ground coffee.
- ▶ Insert a JURA cleaning tablet into the filler funnel.

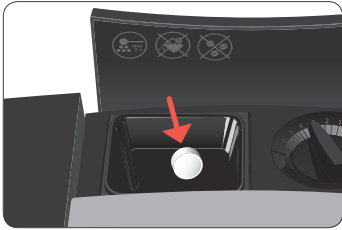

- ▶ Close the cover of the filler funnel.
- ▶ Touch 'Next'.
'Machine is being cleaned'
'Empty coffee grounds container' / 'Empty drip tray'
- ▶ Empty the drip tray and coffee grounds container and put them back into the machine.

Descaling the machine

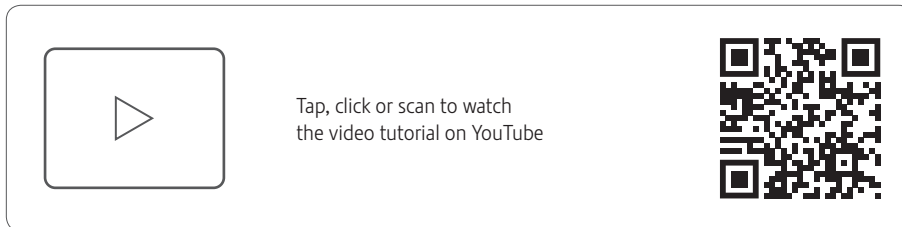

The J10 builds up deposits of limescale over time and automatically prompts you to descale it when necessary. The degree of calcification depends on the hardness of your water.

i If you are using a CLARIS Smart+ filter cartridge, you will not be prompted to descale.

⚠ CAUTION

If the descaling agent comes into contact with the skin or eyes, this can cause irritation.

- ▶ Avoid contact with the skin or eyes.
- ▶ Rinse off the descaling agent with clean water. Should you get any descaling agent in your eye, see a doctor.

CAUTION

If the wrong descaling agent is used, the machine could be damaged and/or traces could be left behind in the water.

- ▶ Use only original JURA maintenance products.

CAUTION

If the descaling operation is interrupted, there may be damage to the machine.

- ▶ Allow the descaling programme to run to the end.

CAUTION

If the descaling agent comes into contact with sensitive surfaces (e.g. marble), damage cannot be ruled out.

- ▶ Clean up any splashes immediately.

-
- i** The descaling programme lasts approximately 20 minutes.
 - i** JURA descaling tablets are available from specialised dealers.

Precondition: 'Descale' is displayed in the Cockpit.

- ▶ Tap 'Descale'.
- ▶ Touch 'Start'.
'Empty drip tray' / 'Empty coffee grounds container'
- ▶ Empty the drip tray and coffee grounds container and put them back into the machine.
'Pour descaling agent into water tank'
- ▶ Remove and empty the water tank.

- ▶ Completely dissolve 3 JURA descaling tablets in a receptacle holding 600 ml of water. This may take several minutes.

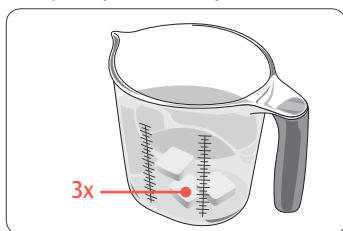

- ▶ Pour the solution into the **empty** water tank and insert it into the machine.
- ▶ Place one receptacle under the coffee spout and another under the fine foam frother.



- ▶ Touch **'Next'**.
'Machine is being descaled', water flows repeatedly out of the hot-water spout and fine foam frother straight into the drip tray.
'Empty drip tray' / **'Empty coffee grounds container'**
- ▶ Empty the drip tray and coffee grounds container and put them back into the machine.
'Rinse the water tank' / **'Fill water tank'**
- ▶ Empty the receptacles and place them back under the coffee spout and the fine foam frother.



- ▶ Remove the water tank and rinse it thoroughly.
- ▶ Fill the water tank with fresh, cold water and reinsert the tank.
- ▶ Touch **'Next'**.
'Machine is being descaled', water flows repeatedly out of the hot-water spout and fine foam frother straight into the drip tray.
'Empty drip tray' / **'Empty coffee grounds container'**
- ▶ Empty the drip tray and coffee grounds container and put them back into the machine.

i If the descaling operation stops unexpectedly, rinse the water tank thoroughly.

Descaling the water tank

Limescale deposits may form in the water tank. To ensure correct function of the machine, descale the water tank from time to time.

- ▶ Remove the water tank.
- ▶ If you use a CLARIS Smart+ filter cartridge, remove this.
- ▶ Completely fill the water tank and dissolve 3 JURA descaling tablets in it.
- ▶ Leave the water tank with the descaling solution for several hours (e.g. overnight).
- ▶ Empty the water tank and rinse it thoroughly.
- ▶ If you use a CLARIS Smart+ filter cartridge, insert this again.
- ▶ Fill the water tank with fresh, cold water and reinsert the tank.

Cleaning the bean container

Coffee beans may be covered with a slight oil film which remains on the walls of the bean container. These traces may negatively affect the coffee result. For this reason clean the bean container from time to time.

Precondition: **'Fill bean container'** is displayed.

- ▶ Switch the machine off with the On/Off button .
- ▶ Remove the aroma preservation cover.
- ▶ Clean the bean container with a soft, dry cloth.
- ▶ Fill the bean container with coffee beans and close the aroma preservation cover.

8 Display messages

Messages on the start screen

Message	Cause/Result	Action
'Fill water tank'	The water tank is empty. You cannot prepare any products.	▶ Fill the water tank (see chapter 5 'Daily operation – Filling the water tank').
'Empty coffee grounds container' / 'Empty drip tray'	The coffee grounds container is full. / The drip tray is full. You cannot prepare any products.	▶ Empty the coffee grounds container and the drip tray (see chapter 5 'Daily operation – Maintenance actions').
'Drip tray not fitted'	The drip tray is not inserted correctly or is not inserted at all. You cannot prepare any products.	▶ Fit the drip tray.
'Fill bean container'	The bean container is empty. You cannot prepare any speciality coffees, but you can prepare hot water and milk.	▶ Fill the bean container (see chapter 3 'Preparing and using for the first time – Filling the bean container').
'Not enough ground coffee'	There is insufficient ground coffee in the machine; the J10 stops the operation.	▶ The next time you prepare a beverage, add more ground coffee (see chapter 4 'Preparation – Ground coffee').

Messages in the Cockpit

Message	Cause/Result	Action
The filter symbol  lights up red. 'Change the filter'	The filter cartridge is used up.	▶ Replace the CLARIS Smart+ filter cartridge (see chapter 7 'Maintenance – Inserting/changing the filter').
'Clean'	The J10 is prompting you to clean it.	▶ Perform cleaning (see chapter 7 'Maintenance – Cleaning the machine').
'Descale'	The J10 is prompting you to descale it.	▶ Perform descaling (see chapter 7 'Maintenance – Descaling the machine').
'Clean the milk system'	The J10 prompts you to clean the milk system.	▶ Perform milk system cleaning (see chapter 7 'Maintenance – Cleaning the milk system').

9 Troubleshooting

Problem	Cause/Result	Action
Insufficient foam is produced when the milk is frothed or milk sprays out of the fine foam frother.	The fine foam frother is dirty.	▶ Clean the fine foam frother (see chapter 7 'Maintenance – Cleaning the milk system'). ▶ Dismantle and rinse the fine foam frother (see chapter 7 'Maintenance – Dismantling and rinsing the professional fine foam frother').
The 'Coffee Eye' reports a cup under the coffee spout even though no cup has been placed there.	The cup detection sensor behind the coffee spout is dirty.	▶ Clean the sensor with a damp cloth.
Coffee only comes out in drips when it is being prepared.	The coffee is ground too finely and obstructs the system.	▶ Put the grinder on a coarser setting or use coarser ground coffee
	The water hardness may not have been correctly set.	▶ Perform descaling (see chapter 7 'Maintenance – Descaling the machine').
There is dry ground coffee behind the coffee grounds container.	The beans used are resulting in an above-average volume of ground coffee.	▶ Reduce the coffee strength or choose a finer grinder setting (see chapter 4 'Preparation – Adjusting the product settings').
'Fill water tank' is not displayed although the water tank is empty.	There is a lot of limescale in the water tank.	▶ Descale the water tank (see chapter 7 'Maintenance – Descaling the water tank').
Grinder is making a very loud noise.	There are foreign objects in the grinder.	▶ Contact customer support in your country (see chapter 13 JURA contact details / Legal information').

Problem	Cause/Result	Action
'Error 2' or 'Error 5' is displayed.	If the machine has been exposed to the cold for a long period of time, heating may be disabled for safety reasons.	▶ Warm the machine at room temperature.
Other 'Error' messages are displayed.	–	▶ Switch the J10 off with the On/Off button ϕ . Contact customer support in your country (see chapter 13 JURA contact details / Legal information').

i If you were unable to solve the problem, contact customer support in your country (see chapter 13 JURA contact details / Legal information').

10 Transport and environmentally friendly disposal

Transport / Emptying the system

Keep the packaging for your J10. It should be used to protect the machine during transport.

In order to protect the J10 from frost during transport, the system must be emptied.

Precondition: The start screen is displayed.

- ▶ Remove the milk pipe from the fine foam frother.
- ▶ Place a receptacle under the fine foam frother.



- ▶ To go to the JURA Cockpit, swipe across the start screen from bottom to top.

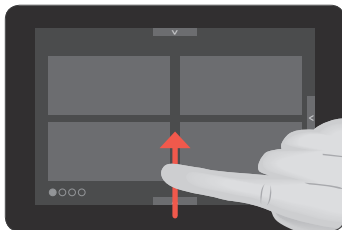

- ▶ Touch the 'Machine setting'  symbol.
- ▶ Switch to the '3/3' page.
- ▶ Touch 'Empty system'.
- ▶ Remove and empty the water tank.
- ▶ Touch 'Next'.

Steam will continue to be discharged from the fine foam frother until the system is empty.
Your J10 is switched off.

Disposal

Please dispose of old machines in an environmentally neutral way.



Old machines contain valuable, recyclable materials which should be recycled. Please therefore dispose of old machines via suitable collection systems.

11 Technical data

Voltage	220–240 V ~, 50 Hz
Power	1450 W
Conformity mark	CE UK
Pump pressure	static, max. 15 bar
Holding capacity of water tank (without filter)	1.9 l
Holding capacity of bean container	280 g
Holding capacity of coffee grounds container	max. 16 portions
Cable length	approx. 1.1 m
Weight	10.6 kg
Dimensions (W × H × D)	31.8 × 34.8 × 44.6 cm
Milk system with connector	HP3
Interchangeable milk spout	CX3
CLARIS filter cartridge Smart+ (RFID technology)	Frequency band 13.56 MHz Max. transmission power < 1 mW
JURA Wi-Fi Connect (Wi-Fi connection)	Frequency band 2.4 GHz Max. transmission power < 100 mW
JURA type	764

Information for testers (repeat test in accordance with DIN VDE 0701-0702): The central grounding point (CGP) is located on the back of the machine, right next to the mains cable's connection point.

12 Index

A

- Addresses 28
- Adjusting the product settings 15
- Americano 13
- Aroma preservation cover
 - Bean container with aroma preservation cover 4

B

- Bean container
 - Bean container with aroma preservation cover 4
 - Cleaning 23
 - Filling 7
- Bus bar
 - Technical data 26
- Button
 - On/Off button 4

C

- Caffè latte 13
- Cappuccino 13
- Central grounding point 26
- Children 5
- CLARIS Smart filter cartridge
 - Changing 20
 - Inserting 20
- Cleaning
 - Bean container 23
 - Machine 21
- Cockpit 9, 17
- Coffee 11
- Coffee grounds container 4
- Coffee spout
 - Height-adjustable coffee spout 4
- Cold Brew 12
- Consistency of grind
 - Grinder adjustment switch 4
- Contact details 28
- Cover
 - Filler funnel for ground coffee 4
 - Water tank 4

- Cup grille 4
- Customer support 28

D

- Damage
 - Preventing damage 6
 - What to do in the event of damage 5
- Declaration of Conformity 28
- Descaling
 - Machine 22
 - Water tank 23
- Display
 - Cockpit 9
 - Touch display 4
- Display messages 24
- Disposal 25
- Drip tray 4
 - Insert 4

E

- Emptying the system 25
- Errors
 - Troubleshooting 24
- Espresso 11
- Espresso doppio 13
- EU Declaration of Conformity 28

F

- Filler funnel
 - Filler funnel for ground coffee 4
- Filling
 - Bean container 7
 - Water tank 16
- Filter
 - Changing 20
 - Inserting 20
- Fine foam frother
 - Professional fine foam frother 4
- First-time use 7
- Flat white 13

- G**
 Grinder adjustment switch 4
 Ground coffee 13
 Measuring spoon for ground coffee 4
 Grounding point 26
- H**
 Height-adjustable coffee spout 4
 Hotline 28
 Hot water 14
 Hot-water spout 4
- I**
 Insert for drip tray 4
 Instant coffee
 Ground coffee 13
 Interchangeable milk spout 26
- J**
 JURA
 Contact details 28
- L**
 Latte macchiato 13
 Lungo 13
- M**
 Macchiato 13
 Machine
 Cleaning 21
 Descaling 22
 Rinsing 18
 Setting up 7
 Machine settings 17
 Mains cable 4
 Maintenance 17
 Maintenance actions 16
 Measuring spoon for ground coffee 4
 Messages, display 24
 Milk 13
 Connecting milk 9
 Milk foam 13
 Milk system 26
 Clean 19
 Professional fine foam frother 4
 Rinsing 18
 Syrup attachment 4, 11
 Milk system rinsing 18
- P**
 Preparation 10, 13
 Americano 13
 Caffè latte 13
 Cappuccino 13
 Coffee 11
 Cold Brew 12
 Espresso 11
 Espresso doppio 13
 Flat white 13
 Ground coffee 13
 Hot water 14
 Latte macchiato 13
 Lungo 13
 Macchiato 13
 Milk 13
 Milk foam 13
 Speciality Selection 10
 Sweet latte 11
- Problems
 Troubleshooting 24
 Product settings
 Adjusting 15
 Professional fine foam frother 4
 Dismantling and rinsing 19
 Proper use 5
- R**
 RFID 26
 Rinsing
 Machine 18
- S**
 Safety information 5
 Service socket 4
 Setting up
 Setting up the machine 7
 Speciality Selection
 Extra Shot 10
 Ground coffee 10
 Spout
 Hot-water spout 4
 Sweet latte 11
 Switching off 15
 Switching on 15
 Symbol description 5
 Syrup attachment 4, 11
- T**
 Technical data 26
 Interchangeable milk spout 26
 Milk system 26
 Tel 28
 Touch display 4
 Transport 25
 Troubleshooting 24
- U**
 Use, First-time 7
 Users 5
- W**
 Water hardness
 Determining the water hardness 7
 Water tank 4
 Descaling 23
 Filling 16
 Wi-Fi 26
 Wi-Fi Connect 4, 10
 Wi-Fi connection 10
 Wireless connection 10, 20, 26

13 JURA contact details / Legal information

JURA Elektroapparate AG
Kaffeeweltstrasse 10
CH-4626 Niederbuchsiten
Tel. +41 (0)62 38 98 233

- i** You can find additional contact details for your country at [jura.com](https://www.jura.com).
- i** If you need assistance with using your machine, you can find this at [jura.com/service](https://www.jura.com/service).
- i** Your opinion is important to us! Use the contact details at [jura.com](https://www.jura.com).

Directives

The machine complies with the following directives:

- 2014/35/EU – Low Voltage Directive
- 2014/30/EU – Electromagnetic Compatibility
- 2009/125/EC – Ecodesign Directive
- 2011/65/EU – RoHS Directive
- 2014/53/EU – Wireless Voltage Directive

A detailed EU Declaration of Conformity for your J10 can be found at [jura.com/conformity](https://www.jura.com/conformity).

Technical changes

We reserve the right to make technical changes. The diagrams used in these instructions for use are for illustration purposes only and do not represent the original colours of the machine. Some details of your J10 may vary.