

Operating instructions Coffee machine



To avoid the risk of accidents or damage to the appliance it is **essential** to read these instructions before it is installed and used for the first time.

Caring for the environment

Disposing of the packaging material

The packaging material is used for handling and protects the appliance from transport damage. The packaging material used is selected from materials which are environmentally friendly for disposal and can generally be recycled.

Recycling the packaging material reduces the use of raw materials. Use material-specific collection points for valuable materials and take advantage of return options.

We recommend you keep the packaging material for transport purposes.

Disposing of your old appliance

Electrical and electronic appliances contain many valuable materials. They also contain certain materials, compounds and components which were essential for their correct functioning and safety. These could be hazardous to human health and to the environment if disposed of with household waste or if handled incorrectly. Please do not, therefore, dispose of your old appliance with household waste.



Instead, please make use of officially designated collection and disposal points to dispose of and recycle electrical and electronic appliances in your local community, with your dealer or with Miele, free of charge. By law, you are solely responsible for deleting any personal data from the old appliance prior to disposal. You are legally obliged to remove any old batteries which are not securely enclosed by the appliance and to remove any lamps without destroying them, where this is possible. These must be taken to a suitable collection point where they can be handed in free of charge. Please ensure that your old appliance poses no risk to children while being stored for disposal.

Caring for the environment	2
Warning and Safety instructions	6
Product description	17
Controls and indicators	18
Accessories	19
Operation	20
Before using for the first time	21
Water hardness	23
Filling the water container	24
Filling the coffee bean container	25
Switching on and off	26
Adjusting the central spout to the correct cup height	27
Making drinks	28
Making coffee with and without milk.....	28
Milk preparation.....	28
Using milk cartons or bottles	29
Making a coffee.....	29
Cancelling a drink.....	29
2 portions (sensor control )	30
Coffee pot.....	30
Making coffee drinks with ground coffee	31
Adding ground coffee.....	31
Dispensing hot water (CM 5410, CM 5510, CM 5710).....	32
Grinder setting	33
Quantity of coffee, brew temperature and pre-brewing	34
Quantity of coffee.....	34
Brewing temperature	34
Pre-brewing the ground coffee.....	34
Portion size	35
Profiles	37
Creating profiles	37

Contents

Changing drinks within a profile	37
Making drinks stored in a profile	37
Changing the name	37
Deleting a profile	37
Setting when the profile should change (Change profile)	38
Settings	39
Displaying and changing Settings	39
Language.....	39
Timer: switch off after.....	39
Eco mode	39
Info (display information)	39
System lock 	39
Water hardness	39
Display brightness	39
Volume.....	39
Factory defaults.....	39
Demo mode (showroom programme)	40
Cleaning and care	41
Overview of cleaning intervals.....	41
Cleaning by hand or in the dishwasher	42
Unsuitable cleaning agents	43
Waste container, drip tray and drip tray cover	44
Cleaning the water container	45
Removing and cleaning the water container filter	45
Central spout.....	46
Milk pipework	48
Bean container and ground coffee chute	48
Cleaning the casing.....	49
Opening the Maintenance menu	49
Rinsing the appliance	49
Rinsing the milk pipework	49
Degreasing the brew unit and cleaning the interior	51
Descaling the machine	54
Transporting the machine	56
Evaporating the coffee machine.....	56
Packing the machine	56
Problem solving guide	57
Messages in the display	57
Unusual performance of the coffee machine	60
Unsatisfactory results.....	66

Contents

After sales service and warranty	68
Contact in the event of a fault	68
Warranty	68
Saving energy	69
Electrical connection	70
Installation	71
Dimensions	72
Technical data	73

Warning and Safety instructions

This coffee machine complies with all the stipulated safety requirements. Inappropriate use can, however, lead to personal injury and material damage.

Read the operating instructions carefully before using the coffee machine. They contain important information on the installation, safety, use and maintenance of the appliance. This prevents both personal injury and damage to the coffee machine.

In accordance with standard IEC 60335-1, Miele expressly and strongly advises that you read and follow the instructions in the chapter on installing and connecting the coffee machine as well as the safety instructions and warnings.

Miele cannot be held liable for injury or damage caused by non-compliance with these instructions.

Keep these operating instructions in a safe place and pass them on to any future owner.

Correct application

- ▶ This coffee machine is intended for home use.
- ▶ This coffee machine is not intended for outdoor use.
- ▶ This coffee machine must not be used at altitudes above 2000 m.
- ▶ It must only be used as a domestic appliance to make espresso, cappuccino, latte macchiato etc. Any other use is not permitted.
- ▶ This coffee machine can only be used by people with reduced physical, sensory or mental capabilities, or lack of experience and knowledge, if they are supervised whilst using it, or have been shown how to use it in a safe way and recognise and understand the consequences of incorrect operation.

Warning and Safety instructions

Safety with children

 Danger of burning and scalding on the dispensing spouts.

Children's skin is far more sensitive to high temperatures than that of adults.

Ensure children do not touch hot surfaces of the coffee machine or place parts of their body under the dispensing spouts.

- ▶ Install the coffee machine where it is out of the reach of children.
- ▶ Children under 8 years of age must be kept away from the coffee machine and the mains connection cable and plug/socket.
- ▶ Children aged 8 and older may only use the coffee machine without supervision if they have been shown how to use it in a safe manner.
Children aged 8 and older must be aware of the potential dangers caused by incorrect operation.
- ▶ Please supervise children in the vicinity of the coffee machine and do not allow them to play with it.
- ▶ Young children must not be allowed to clean the coffee machine at all. Cleaning may only be carried out by children 8 years of age or older under the supervision of an adult.
- ▶ Remember that coffee and espresso are not suitable drinks for children.
- ▶ Danger of suffocation! Whilst playing, children may become entangled in packaging material (such as plastic wrapping) or pull the packaging material over their head, presenting the risk of suffocation. Keep packaging material away from children.

Technical safety

- ▶ A damaged coffee machine is dangerous. Check it for any visible damage before setting it up. Never attempt to use a damaged coffee machine.
- ▶ To avoid the risk of damage to the machine, make sure the connection data (voltage and frequency) on the data plate corresponds to the household supply, before connecting the machine to the mains supply. Consult a qualified electrician if in any doubt.
- ▶ The electrical safety of this coffee machine can only be guaranteed when correctly earthed. It is essential that this standard safety requirement is met. If in any doubt please have the electrical installation tested by a qualified electrician.
- ▶ Temporary or permanent operation on an autonomous power supply system or a power supply system that is not synchronised with the mains power supply (e.g. island networks, back-up systems) is possible. A prerequisite for operation is that the power supply system complies with the specifications of EN 50160 or an equivalent standard.

The function and operation of the protective measures provided in the domestic electrical installation and in this Miele product must also be maintained in isolated operation or in operation that is not synchronised with the mains power supply, or these measures must be replaced by equivalent measures in the installation. As described, for example, in the current version of BS OHSAS 18001–2 ISO 45001.
- ▶ Do not connect the machine to the mains electricity supply by a multi-socket adapter or an extension lead. These are a fire hazard and do not guarantee the required safety of the appliance.
- ▶ The coffee machine must not be used in a non-stationary location (e.g. on a ship).

Warning and Safety instructions

- ▶ Unplug the machine from the power supply immediately if you notice any damage or smell scorching, for example.
- ▶ Ensure that the mains connection cable cannot be pinched or damaged by any sharp edges.
- ▶ The mains connection cable should not hang down. Someone could trip over it with the risk of injury and damage the machine.
- ▶ Only use the coffee machine in rooms where the ambient temperature is between +10 °C and +38 °C.
- ▶ Position the coffee machine at a height of at least 850 mm from the floor.
- ▶ Danger of overheating. Please ensure that there is adequate ventilation around the coffee machine. Do not cover the coffee machine with tea towels etc. while it is in use.
- ▶ If the coffee machine is installed behind a closed furniture front, it may only be used with the furniture door open (see “Installation” for the minimum niche size). Heat and moisture can build up behind the furniture front when closed. This can result in damage to the appliance and/or furniture unit. Do not close the furniture front while the coffee machine is in use. Leave the furniture door open until the coffee machine has cooled down completely.
- ▶ Protect the coffee machine from water and water spray. Do not immerse the machine in water.
- ▶ Repairs and other work by unqualified persons to the machine and the connection cable could be dangerous. The manufacturer cannot be held liable for unauthorised work. Repairs may only be carried out by a Miele authorised service technician.
- ▶ While the machine is under warranty, repairs should only be undertaken by a Miele authorised service technician. Otherwise the warranty is invalidated.

Warning and Safety instructions

- ▶ The coffee machine must be disconnected from the electricity supply during repair work.
- ▶ Never open the outer casing of the machine. Tampering with electrical connections or components and mechanical parts is highly dangerous to the user and can cause operational faults or electric shock.

Warning and Safety instructions

Correct use

 Danger of burning and scalding on the dispensing spouts. The liquids and steam dispensed are very hot.

Keep well away from the area underneath the spouts when hot liquids and steam are being dispensed.

Do not touch hot components.

Hot liquid or steam could spatter from the spouts. Ensure that the central spout is clean and fitted correctly.

Water in the drip tray can also be very hot. Take care when emptying it.

► Please note the following regarding water:

- The water quality must conform to the requirements for drinking water in the country in which the coffee machine is being used.
- Only use cold, fresh tap water to fill the water container. Hot or warm water or other liquids can damage the coffee machine.
- Change the water every day to prevent a build-up of bacteria.
- Do not use carbonated water.

► Only fill the bean container with roasted espresso/coffee beans. Do not fill the bean container with coffee beans which have been treated with additives or with ground coffee.

► Do not fill the bean container with any type of liquid.

► Do not use green (unroasted) coffee beans or mixtures of coffee beans which contain green coffee beans. Green coffee beans are very hard and still contain residual moisture. These can damage the coffee machine grinder as soon as grinding begins.

► Do not use coffee beans which have been treated with caramel, sugar or other substances including sugary liquids. Sugar will damage the coffee machine.

► Only fill the coffee chute with ground coffee beans.

Warning and Safety instructions

- ▶ Do not use any caramelised ready ground coffee. The sugar in the coffee will stick to and block the brew unit of the coffee machine. The cleaning tablets for degreasing the brew unit will not remove this type of deposit.
- ▶ Only use milk without additives. Additives in milk usually contain sugar and this will stick to the milk pipework.
- ▶ If using dairy milk make sure that it has been pasteurised.
- ▶ Do not place flaming alcohol mixtures underneath the central spout. The flames could ignite plastic components and cause them to melt.
- ▶ Do not use naked flames, e.g. a candle, on or near the coffee machine. The coffee machine could catch fire with the risk of the fire spreading.
- ▶ The machine must not be used for cleaning objects.

Warning and Safety instructions

Accessories and spare parts

- ▶ Miele can only guarantee the safety of the machine when original Miele spare parts are used. Faulty components must only be replaced by genuine Miele original spare parts.
- ▶ Only use original Miele accessories. If other parts are used, warranty, performance and/or product liability claims will be invalidated.
- ▶ Miele will guarantee to supply functional spare parts for a minimum of 10 years and up to 15 years following the discontinuation of your coffee machine.

Cleaning and care

- ▶ Disconnect the coffee machine from the power supply before cleaning.
- ▶ Clean the coffee machine daily, particularly before using for the first time (see “Cleaning and care”).
- ▶ All parts of the milk system need to be cleaned thoroughly and regularly. Milk contains bacteria which proliferate rapidly with inadequate cleaning.
- ▶ Do not use a steam cleaner to clean this machine. Steam could reach electrical components and cause a short circuit.
- ▶ Descale the coffee machine regularly depending on the water hardness level in your area. Descale the machine more frequently in areas with very hard water. Miele cannot be held liable for damage arising from insufficient descaling, the use of incorrect descaling agent or the use of descaling agent which is not of the appropriate concentration.
- ▶ Degrease the brew unit regularly with Miele cleaning tablets. Depending on the natural oil content of the coffee used, the brew unit can become blocked quite quickly.

Warning and Safety instructions

- ▶ Used coffee grounds should be disposed of with the organic rubbish or on the compost heap. Do not empty them down the sink, as they could block it.

Warning and Safety instructions

For machines with stainless steel surfaces:

- ▶ Do not use sticky notes, adhesive tape, masking tape or other types of adhesive on the stainless steel surfaces.
- ▶ Stainless steel surfaces are susceptible to scratching. Even magnets can cause scratches.



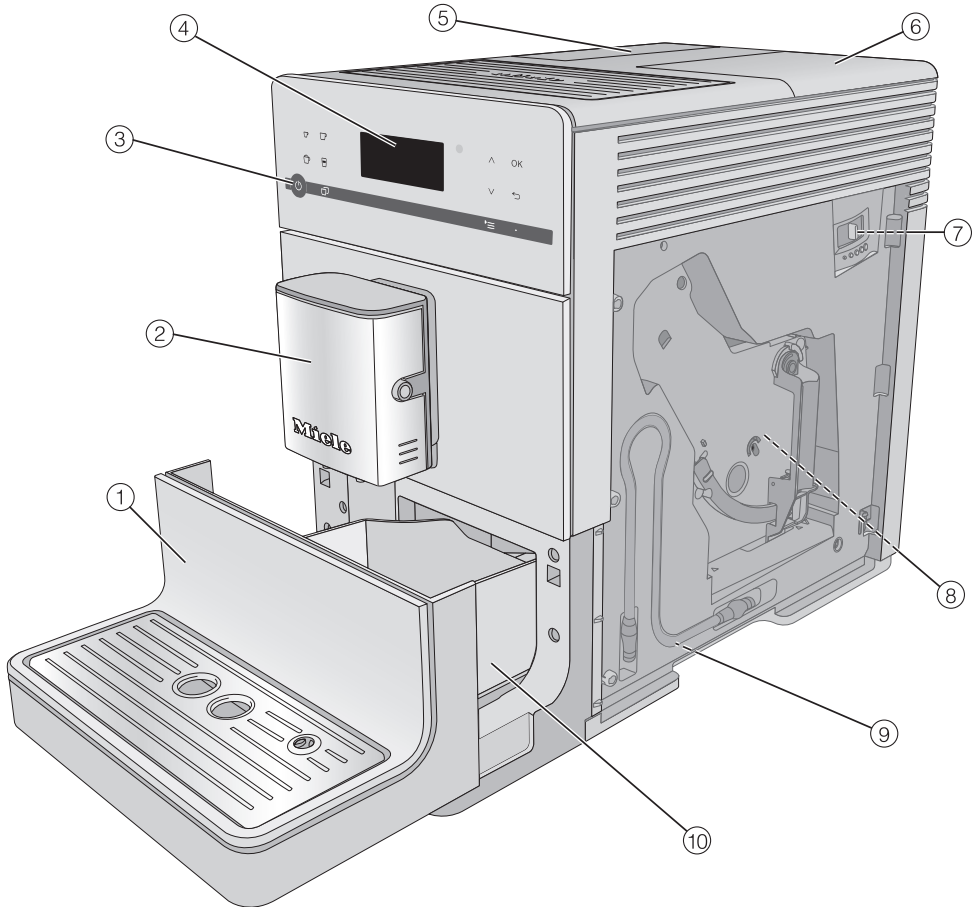





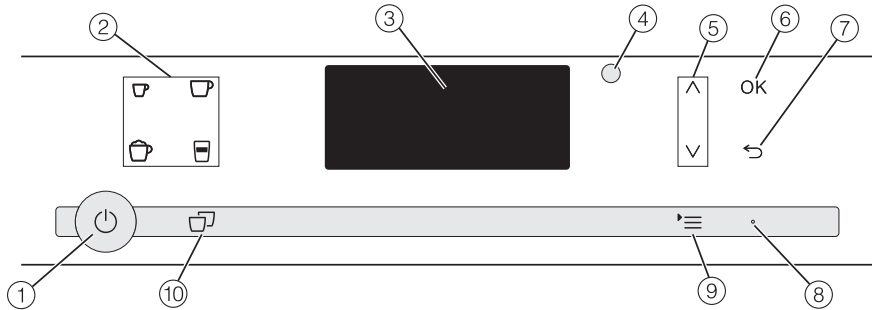

Product description



- ① Lower panel with drip tray cover
- ② Central spout with Cappuccinatore and hot water spout
- ③ On/Off button 
- ④ Control panel
- ⑤ Water container
- ⑥ Bean container and ground coffee chute
- ⑦ Grinder setting (behind the appliance door)
- ⑧ Brew unit (behind the appliance door)
- ⑨ Park position for milk tube
- ⑩ Drip tray with lid and waste container

Controls and indicators



- ① **On/Off button** 
For switching coffee machine on and off
- ② **Drink buttons**
Making drinks
 -  Espresso
 -  Coffee
 -  Cappuccino
 -  Latte macchiato
- ③ **Display**
For showing information about the current action or status
- ④ **Optical interface**
(For Miele Customer Service Department only)
- ⑤ **Arrow buttons**  
For scrolling through lists, selecting entries or changing values
- ⑥ **OK sensor**
For confirming display messages and saving settings
- ⑦ **“Back”**  **sensor**
For returning to the previous menu and cancelling unwanted actions
- ⑧ **LED**
Flashes when the appliance is switched on and the display is in energy saving mode
- ⑨ **Sensor control** 
Other drinks
Profiles (CM 5410, CM 5510, CM 5710)
Maintenance
Parameters
Settings 
- ⑩ **“2 portions”**  **sensor**
For dispensing 2 portions of a drink at once

These products and other useful accessories can be ordered via the Miele webshop, from Miele (see back cover for contact details) or from your Miele dealer.

Accessories supplied

- **Starter set “Miele appliance care”**
Various cleaning products are supplied depending on model.
- **Cleaning brush**
for cleaning the milk pipework

Optional accessories

Miele accessories and cleaning and conditioning products are available for your coffee machine.

- **Microfibre cloth**
for removing finger marks and light soiling
- **Cleaning agent for milk pipework**
for cleaning the milk system
- **Cleaning tablets**
for degreasing the brew unit
- **Descaling tablets**
for descaling the water pipework
- **CJ Jug 1.0 l**
Insulated flask for coffee or tea (pot function)
- **Milk container with lid**
For storing and preparing milk

Operation

Sensors

To operate the coffee machine, touch the sensors with your finger.

An audible signal is generated each time a sensor is touched. You can adjust the volume of the signal tones or switch the tones off (see “Settings – Volume”).

Drinks menu

When the following appears in the display, you are in the drinks menu: Select drink.

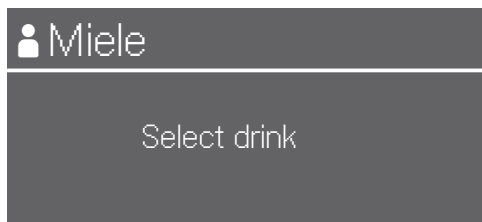

You can find more drinks in the Other drinks menu (*≡ sensor control).

Selecting a menu and navigating within a menu

To select a menu, touch the sensor control *≡.



You will then be able to start an action or change settings in the menu. A bar on the right-hand side of the display indicates that further options or text are available.

To select an option, keep pressing the arrow buttons ^ and v until the menu option you want is highlighted.

Touch the OK sensor control to confirm your selection.

The setting which is currently selected in a list will have a tick ✓ beside it.

Exiting a list or cancelling an action

To exit the current menu, touch the ↶ sensor control.

Before using for the first time

Before using for the first time

- Remove any labels from the machine.

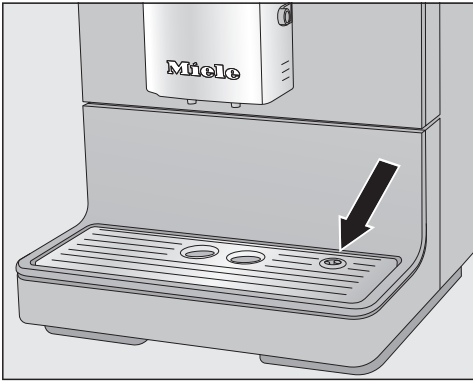

- Remove the protective foil from the drip tray cover and place the drip tray cover into the lower panel.
- Place the coffee machine on a level flat surface that is not sensitive to water (see “Installation”).

Clean the coffee machine thoroughly (see “Cleaning and care”) before filling it with water and coffee beans.

- Insert the plug of the coffee machine into the socket.
- Remove the water container and fill it with fresh, cold tap water. Only fill the water container up to the “max.” marker and then refit it in the machine.
- Take the lid off the coffee bean container, fill it with roasted coffee beans and replace the lid.

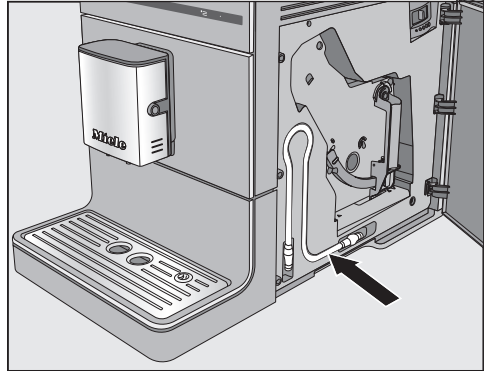

Tip: The milk pipework can be stored behind the appliance door when not in use.

Switching on for the first time

- Touch the On/Off button .

The welcome message Miele – Willkommen will appear on the display briefly.

- Use the arrow sensors \wedge \vee to highlight the required language. Touch **OK**.

You might also be asked for your location.

Your machine has been successfully set up and is ready for use.

- Confirm with **OK**.

The coffee machine heats up and rinses the pipework. The water used for rinsing will run out of the central spout.

- Before preparing milk for the first time, rinse the milk pipework (see “Cleaning and care – Rinsing the milk pipework”).

Before using for the first time

Please note that the full aroma of the coffee and typical crema will not develop fully until several coffees have been made.

To ensure that any coffee residues from the factory testing process are removed from the brewing system, please throw away the first 2 cups of coffee when using the coffee machine for the first time.

For the first coffee drinks, a larger quantity of coffee beans is ground. This means that powder from the coffee grounds may adhere to the lid of the drip tray.

Water hardness is an indication of the amount of minerals dissolved in water. The more minerals in the water, the higher the water hardness. The harder the water is, the more frequently the coffee machine needs to be descaled.

The coffee machine measures the amount of water used and steam made. Depending on the level of water hardness set, more or fewer drinks can be dispensed before the appliance needs to be descaled.

Set the water hardness level on the coffee machine to the water hardness level for the local area to ensure that the appliance functions correctly and is not damaged. A prompt to descale the coffee machine will then appear in the display at the correct time.

Contact your local water supplier to find out the water hardness in your area.

The machine is programmed ex-works to hardness level 3.

The appliance has 4 programmable hardness levels:

°dH	mmol/l	ppm (mg/l CaCO ₃)	Set- ting*
0–8.4	0–1.5	0–150	Soft 1
8.4–14	1.5–2.5	150–250	Medium 2
14–21	2.5–3.8	250–375	Hard 3
> 21	> 3.8	> 375	Very hard 4

* The hardness level shown in the display may differ from the hardness level in your area. You **must** follow the values in the chart to set your coffee machine to your local water hardness level.

Setting the water hardness

- Touch the '☰ sensor control.
- Select Settings  | Water hardness and confirm with OK.
- Select the hardness level and confirm with OK.

The setting is now saved.

Filling the water container

⚠ Risk to health due to contaminated water.

Bacteria can develop in water which has been sitting in the water container for too long and is a risk to your health.

Change the water in the water container **every day**.

⚠ Risk of damage due to incorrect operation.

Unsuitable liquids such as hot or warm water or other liquids can damage the coffee machine. Bottled mineral water leaves too much limescale in the coffee machine.

Only use cold, fresh tap water to fill the water container.

- Replace the water container and close the lid.

Make sure that the water container handle is on the right so that the lid can close properly.

If the water container sits a little too high or at an angle, check that it is fitted correctly or whether the surface that it sits on is soiled. Water could leak. If necessary clean the surface that the water container sits on.

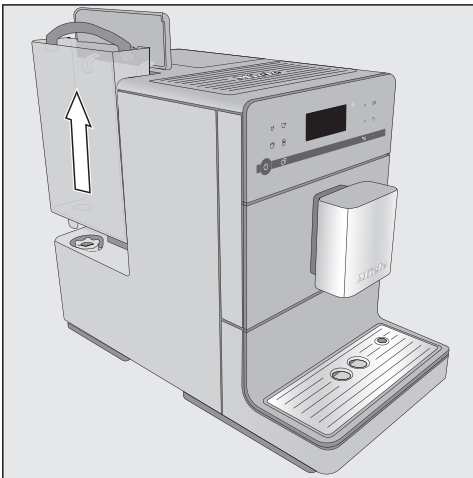

- Open the lid on the left hand side of the coffee machine.
- Pull the water container upwards and out.
- Fill the water container with fresh, cold tap water up to the “Max.” mark.

Filling the coffee bean container

Coffee or espresso can be made from whole roasted coffee beans which are freshly ground in the coffee machine for each portion. This requires the coffee bean container to be filled with coffee beans.

Alternatively, you can make coffee drinks with ready ground coffee.

 Risk of damage to the grinder due to incorrect operation.

The coffee machine will be damaged if the bean container is filled with unsuitable substances such as liquids, ground coffee or coffee beans treated with caster sugar, caramel or similar.

In addition, green (unroasted) coffee beans or mixtures of coffee beans which contain green coffee beans can damage the grinder. Green coffee beans are very hard and still contain residual moisture. These can damage the coffee machine grinder as soon as grinding begins.

Only put roasted coffee beans in the bean container.

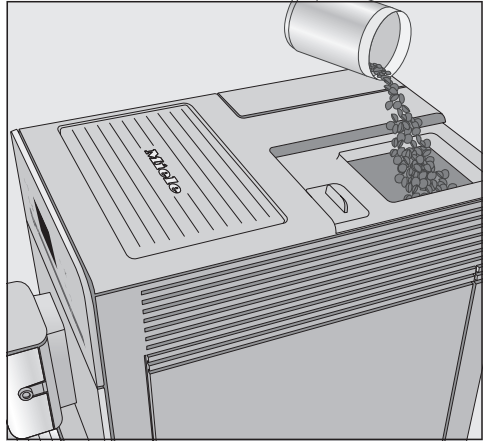

- Take the lid off the coffee bean container.
- Fill the container with roasted coffee beans.
- Replace the lid.

Tip: You can use a nut or seed grinder to grind green coffee beans. These types of grinder generally have a rotating stainless steel blade. You can then add the ground green coffee **one portion at a time** to the ground coffee chute and make the desired coffee drink.

Switching on and off

Switching the coffee machine on

- Touch the On/Off button .

The appliance heats up and rinses the pipework. Hot water will run out of the central spout.

When *Select drink* appears in the display, you can make drinks.

If the coffee machine is already at operating temperature, rinsing will not take place.

If you do not touch any buttons or run any maintenance programmes, the display will switch itself off after approx. 7 minutes to save energy.

The right-hand LED will flash on and off as long as the coffee machine is switched on.

- Touch one of the sensor controls to wake the coffee machine up again to make a drink.

Switching the coffee machine off

- Touch the On/Off button .

If coffee has been dispensed, the coffee machine will rinse the pipework automatically before switching off.

If you have made a drink using milk, Place milk pipe in drip tray will appear in the display.

- Insert the end of the milk pipework into the aperture in the drip tray, then touch *OK*.

Switching off for longer periods of time

If the coffee machine is not going to be used for a while, e.g. if you are going on holiday, remember to do the following:

- Empty the drip tray, the waste container and the water container.
- Clean all parts thoroughly, including the brew unit.
- If necessary, switch off the coffee machine and unplug it to disconnect it from the power supply.

Adjusting the central spout to the correct cup height

You can adjust the central spout to suit the height of the cup you are using so that the coffee or espresso will not cool down as quickly and the crema will have a better consistency.

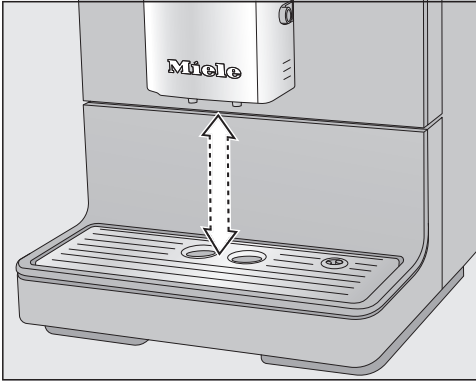

- Pull the central spout down until it is at the same level as the rim of the cup.
Alternatively, push the central spout up until there is enough room to fit a larger cup or mug underneath.

Making drinks

 Danger of burning and scalding on the dispensing spouts.

The liquids and steam dispensed are very hot and can cause scalding.

Keep well away from the area underneath the spouts when hot liquids and steam are being dispensed.

Do not touch hot components.

Making coffee with and without milk

The following drinks can be made:

- **Ristretto** is a strong, concentrated espresso. It is prepared with the same amount of coffee as for an espresso but with a lot less water.
- **Espresso** is a strong aromatic coffee with a thick hazelnut brown coloured froth – known as the crema – on top. We recommend using espresso-roasted coffee beans to make an espresso.
- **Coffee** differs from espresso by the increased amount of water and the roast of the beans. We recommend using coffee beans of the correct roast to make the coffee.
- **Long coffee** is a coffee with considerably more water.
- **Cappuccino** consists of approx. 2 thirds milk froth and 1 third espresso.
- **Latte macchiato** consists of 1 third each of hot milk, milk froth and espresso.

- **Caffè latte** consists of espresso and hot milk.

Hot milk or **milk froth** can also be made.

Milk preparation

Milk or milk alternatives (e.g. soya milk) containing added sugar can clog up the milk pipe and the rest of the milk pipework. Residues from unsuitable liquids can interfere with milk preparation.

The milk used must not contain any additives.

Only use pasteurised cow's milk.

If you have not made any milk drinks for a while, rinse the milk pipework thoroughly before making the first drink.

Tip: Using cold cow's milk (< 10 °C) with a protein content of at least 3 % will produce the perfect milk froth. You can select milk with a fat content according to preference. With whole milk (at least 3.5 % fat), the milk froth will be slightly creamier than with low-fat milk.

Using milk cartons or bottles

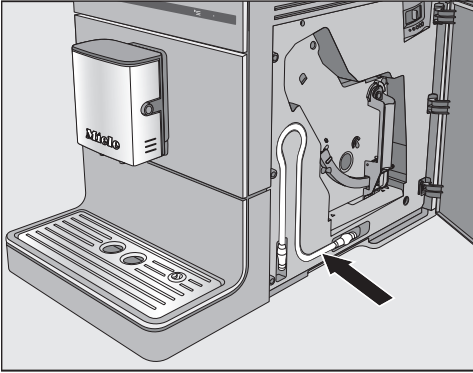

The milk tube for cartons and other suitable containers is located behind the appliance door.



- Connect the milk tube to the aperture in the central spout.
- Place a container with sufficient milk in it beside the coffee machine.
- Place the end of the milk tube in the container. Make sure that it is sufficiently immersed in the milk.

Tip: The Miele milk container is the perfect addition to Miele coffee machines if you make a lot of coffees with milk. The milk container is dishwasher-safe and easy to store in the fridge after use. Good milk froth can only be made with cold milk ($< 10\text{ }^{\circ}\text{C}$). The milk container is available to order via the Miele webshop, from the Miele Customer Service Department (see the end of this booklet for contact details) or from your Miele dealer.

Making a coffee



- Place a cup under the central spout.
- Select a drink: touch the sensor control for the drink you want. Or select a drink from the Other drinks menu (sensor control '≡').

Dispensing will start.

Cancelling a drink

- To cancel making a drink, touch the drinks sensor control or the sensor control '≡' for drinks from Other drinks again.

The coffee machine will stop dispensing.

Making drinks

Tip: As soon as Stop appears in the display, you can cancel making a drink by touching the OK sensor control.

When making **coffee with milk** or **2 portions of a drink** you can cancel each stage individually by touching the OK sensor control.

2 portions (sensor control)

You can dispense 2 portions of a drink into 1 large cup or into 2 cups at the same time.



- Place a cup under each of the coffee dispensers in the central spout.
- Press the  sensor control immediately before or after you start making a drink.

The dispensing starts and 2 portions of the desired drink will be dispensed.

If, after a while, you have not touched any of the drink sensor controls, the “2 portions”  option will revert back to single portions.

Coffee pot

You can make several cups of coffee one after the other automatically with the Coffee pot function (max. 0.75 litre), e.g. to fill a coffee pot. This can make up to 6 cups.

You can use the Coffee pot function twice in a row. After this, the coffee machine needs a cooling down time of one hour in order to avoid it being damaged.

Make sure that the bean container and water container have enough beans and water inside them before starting the Coffee pot function.

- Place a sufficiently large container under the central spout.
- Touch the  sensor control.
- Select Other drinks | Coffee pot and confirm with OK.
- Select the number of cups you want (3 to 6) and confirm with OK.
- Follow the instructions in the display.

Each portion of coffee will be brewed and dispensed individually. You can follow the process in the display.

Cancelling Coffee pot

- Touch the  sensor control.

Coffee pot dispensing will stop.

Tip: A stainless steel vacuum flask is available as an optional accessory from Miele for the “Coffee pot” function. The CJ JUG vacuum flask is available to order via the Miele webshop, from Miele (see back cover for contact details) or from your Miele dealer.

Making coffee drinks with ground coffee

To make drinks using ready ground coffee, add a portion of ground coffee to the ground coffee chute.

This allows you to make a decaffeinated coffee if the bean container is already filled with regular coffee beans, for example.

Only **1** portion of coffee or espresso can be made at a time when using ready ground coffee.

Place a **maximum of 12 g** in the ground coffee chute.
If too much ground coffee is added, the brew unit will not be able to process the coffee.

Adding ground coffee

The coffee machine will use all the ground coffee which has been added to the chute to make the next coffee.

- Touch the '☰' sensor control.
- **Select Other drinks | Ground coffee and confirm with OK.**

Add ground coffee and select drink **will** appear in the display.

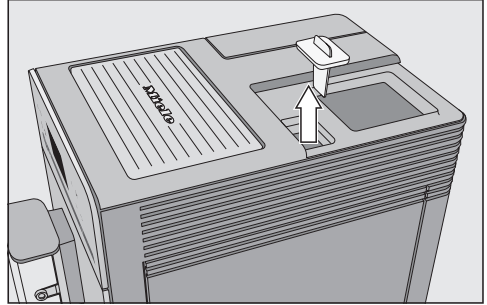

- First take the lid off of the coffee bean container and then take the cover off the ground coffee chute.

Place a **maximum of 12 g** in the ground coffee chute.

- Put the cover back on the ground coffee chute after adding the ground coffee.
- Replace the lid on the coffee bean container.
- Place a cup under the central spout.
- Select a drink.

The coffee will now be made.

Making drinks

Dispensing hot water (CM 5410, CM 5510, CM 5710)

Please note that the water dispensed is not hot enough for making black tea.

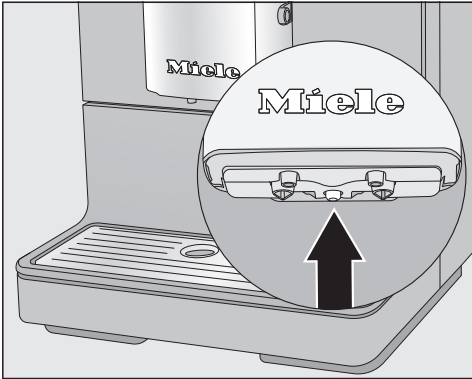

- Place a suitable container centrally underneath the central spout.
- Touch the '☰' sensor control.
- Select Other drinks | Hot water and confirm with OK.

Hot water will run into the container under the central spout.

Grinder setting

The grinder setting determines the contact time between the ground coffee and the water, known as the extraction time. When the ideal grinder setting is selected, the machine dispenses a perfect cup of coffee with a fine, hazelnut-brown crema.

The grinder setting you select will be used for all coffee drinks.

There are various ways to tell whether the coffee grinder is set correctly.

The grinder setting is **too coarse** if the coffee or espresso is watery and tastes acidic. The crema is very pale.

Set a finer grinder setting.

The grinder setting is **too fine** if the coffee or espresso tastes too bitter and the crema is dark brown.

Set a coarser grinder setting.

Only adjust the grinder one setting at a time.

Start making a new drink to grind beans again. Adjust the grinder setting one setting at a time again.

- Open the service panel.

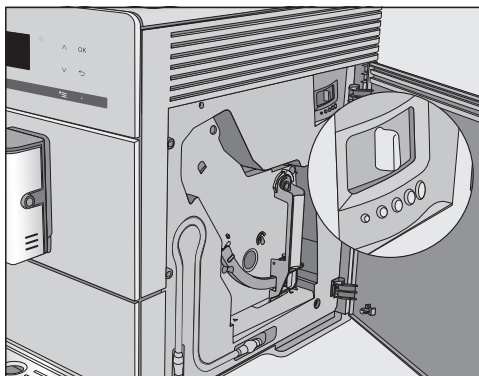

- Push the slide control a maximum of one setting to the left (for finer grinding) or to the right (for coarser grinding).
- Close the service panel.
- Make one cup of coffee.

Adjust the grinder setting again.

The altered grinder setting will not be used until after the second coffee has been dispensed.

Quantity of coffee, brew temperature and pre-brewing

You can set the quantity of coffee, the brewing temperature and pre-brewing for each drink individually. To do this, first select the drink from the Parameters menu and then adjust the drink parameters.

- Touch the '☰ sensor control and select Parameters.
- Select the drink and confirm with *OK*.

The current settings for the quantity of coffee, brewing temperature and pre-brewing will be displayed for this drink.

- Select Amount of coffee, Brew temperature or Pre-brewing.
- Select the setting you want and confirm with *OK*.

The setting is now saved.

CM 5410, CM 5510, CM 5710: The changed parameter is always saved in the current profile. The name of the current profile is shown in the top left of the display.

Quantity of coffee

The coffee machine can grind and brew 6–14 g of coffee beans per cup. The greater the quantity, the stronger the coffee.

The quantity of coffee is **too low** if the espresso or coffee lacks body.

Increase the quantity of coffee so that more ground coffee is brewed.

The quantity of coffee is **too high** if the espresso or coffee tastes bitter.

Decrease the quantity of coffee so that less ground coffee is brewed.

Tip: If the coffee is too strong for you or it tastes bitter, try a different type of bean.

Brewing temperature

The brewing temperature must be adapted to the beans you are using and how they are roasted. It also varies depending on whether you are making espresso or coffee.

Some bean types are sensitive to high brewing temperatures, resulting in an impaired taste. If your coffee tastes bitter, the brewing temperature you have selected might be too high.

Espresso is usually brewed at higher temperatures.

Pre-brewing the ground coffee

When the pre-brewing function is turned on, the ground coffee is first moistened with a little hot water. The ground coffee swells a little. The remaining amount of water is then pressed through the moistened coffee grounds shortly after. If your coffee tastes too bland and you want to add some spice and richness, try the “Pre-brewing” function. Depending on the type of coffee used, pre-brewing can intensify the taste.

You can set a short or long duration for pre-brewing or turn the “Pre-brewing” function off completely.

Tip: We particularly recommend using the “Pre-brewing” function to make coffee.

The flavour of the coffee produced depends not only on the type of coffee, but also on the amount of water used. You can programme the amount of water for all coffee drinks and hot water to suit the size of your cups and the type of coffee you are using. This does not alter the amount of coffee used.

For coffee drinks that use milk, you can not only set the amount of espresso or coffee but also the amount of milk or milk froth to be dispensed with these drinks. Additionally, you can set the portion sizes for hot milk and milk froth alone.

A maximum portion size can be programmed for each type of drink. Dispensing stops once this has been reached. The maximum possible portion size is then saved by the machine for this type of drink.

If the water container becomes empty whilst making a drink, the coffee machine will stop programming the portion size. The portion size will **not** be saved.

There are two ways of initiating the programming of the portion size:

- By touching the drink sensor control when you are making a coffee; or
- By selecting **Portion size** in the **Parameters list**.

CM 5410, CM 5510, CM 5710: The changed portion size is always saved in the current profile. The name of the current profile is shown in the top left of the display.

Cancelling portion size programming

- Touch the drinks sensor control again or the '≡ sensor control for drinks from **Other drinks** again.

Changing the portion size while making a drink

You can change and save the portion size for Espresso ☐, Coffee ☐, Cappuccino ☐ and Latte macchiato ☐ while making these drinks.

- Place a cup under the central spout.
- Touch the sensor control for the drink you want until **Change** appears in the display.

A buzzer will sound as soon as portion programming starts. (As long as the volume has been set for the buzzers – see “Volume”).

The desired drink will be made and **Save** will appear in the display.

- When the cup is filled up to the level you want, confirm with **OK**.

If you want to change the portion size for coffee made with milk, the ingredients which make up the drink will be saved one after the other while the drink is being made.

- When the quantity for each ingredient reaches the level you want, confirm with **OK**.

The programmed mix of ingredients and portion size will now be dispensed every time that particular drink is selected.

Portion size

Changing the portion sizes in the Parameters menu

You can only change the portion sizes for **Long coffee**, **Caffè Latte**, **hot milk** and **milk froth** via the Parameters menu.

- Place a suitable container underneath the central spout.
- Touch the '☰ sensor control and select Parameters.
- Select the drink you want.
- Select Portion size and confirm with *OK*.

Now proceed as for changing the portion size while making a drink.

(CM 5410, CM 5510, CM 5710)

In addition to the Miele drinks menu (Miele profile), you can create individual profiles to cater for different tastes and preferences.

Within the profile, you can adjust the portion sizes and parameters individually for all drinks.

The name of the current profile is shown in the top left of the display.

Creating profiles

- Touch the '≡ sensor control and select Profiles. Confirm with *OK*.

The Profiles menu opens.

- Select Create profile.

The editor will open in the display.

- Enter the profile name:
 - To enter a character, highlight the one you want and confirm your choice with *OK*.
 - To delete a character, touch the ↵ sensor control.
 - To save the name, select the tick ✓ and confirm with *OK*.

The profile has been created.

Changing drinks within a profile

When you change the parameters of a drink within a profile, these settings only apply to the active profile. The settings for drinks contained within other profiles remain unaffected.

- Select the profile you want.

The name of the selected profile is shown in the top left of the display.

You can now change the drinks individually.

Making drinks stored in a profile

- Place a suitable container underneath the central spout.
- Touch the '≡ sensor control and select Profiles.
- Select the profile you want and confirm with *OK*.
- Select the drink you want.

The machine starts dispensing the drink.

Changing the name

This option is only possible if a profile has been allocated in addition to the Miele standard profile.

- Select Change name with the arrow sensors ^v and touch *OK*.
- Now proceed as described in "Creating a profile":
 - Select ↵ to delete a character,
 - To enter new characters, highlight the relevant character and confirm with *OK*,
 - Save the new name by selecting ✓ in the display and touching *OK*.

Deleting a profile

This option can only be selected if a profile has been allocated in addition to the Miele standard profile.

Profiles

- Select **Delete profile** and confirm with *OK*.
- Select the profile you wish to delete.
- Select **Yes** and confirm with *OK*.

The profile will be deleted.

Setting when the profile should change (Change profile)

You can choose between the following options:

- **Manually:** The selected profile will remain active until you select another one.
 - **After each use:** The machine will revert to the Miele profile whenever a drink is dispensed.
 - **When switched on:** The Miele profile will be displayed whenever the coffee machine is switched on, regardless of which profile was selected before the machine was last switched off.
- Select **Change profile** and confirm with *OK*.
 - Select the option you want and confirm with *OK*.

Displaying and changing Settings

The drinks menu is displayed.

- Touch the '☰ sensor control.
- Select **Settings** and confirm with *OK*.
- Select the menu option that you want to display or change.
- Confirm with *OK*.
- Change the setting as required and confirm with *OK*.

Language

You can select the language (and location variant of that language) for all display text.

Tip: If you select the wrong language by mistake, you can find the “Language” option again via the  symbol.

Timer: switch off after

If none of the sensors have been touched or no drink has been made, the coffee machine will switch itself off after 30 minutes to save energy.

You can change this pre-setting using the arrow sensors \vee/\wedge to a time of between 15 minutes and 9 hours.

Eco mode

Eco mode is an energy-saving mode. The system does not heat up until someone starts making a drink.

Eco mode is activated by default.

Info (display information)

You can display the number of drinks dispensed so far and how many more can be dispensed until the maintenance programmes have to be run.

System lock

You can lock the coffee machine to prevent it being used without your knowledge, by children, for example.

Temporarily deactivating the system lock

- Press and hold *OK* for 6 seconds.

The system lock is reactivated when the coffee machine is next switched off.

Water hardness

Information regarding water hardness is given in the “Water hardness” chapter.

Display brightness

Change the display brightness using the arrow sensors \wedge/\vee .

Volume

You can set the volume of buzzer and sensor tones using the arrow sensors \wedge/\vee .

Tip: To switch off the tones, touch the arrow sensor \vee , until no segments are filled and **Switched off** appears.

Factory defaults

You can reset the coffee machine to its factory default settings.

Settings

The following will **not** be reset:

- The number of drinks dispensed and the appliance status (No. of portions until appliance needs descaling, ... brew unit needs degreasing)
- Language
- Profiles and the associated drinks (CM 5410, CM 5510, CM 5710)

Demo mode (showroom programme)

Do not activate this setting for domestic use.

The Showroom programme function enables the coffee machine to be demonstrated in shops or showrooms. Although the sensor controls and display seem to be working, the thermo block is not being heated. The appliance does not dispense any drinks, run the maintenance programmes or save any settings.

You can activate demo mode without commissioning the appliance for the first time. The water container is empty or not inserted. Switch the coffee machine on. As soon as the Fill and replace the water container message appears, touch the ↶ button for 5 seconds. Demo mode is activated.



Risk to health due to inadequate cleaning

Heat and moisture inside the coffee machine can cause coffee residues to become mouldy and/or milk residues to go off and pose a risk to health.

Carefully clean the coffee machine regularly.

Overview of cleaning intervals

Recommended frequency	What do I have to clean / maintain?
Daily (at the end of the day)	Water container
	Waste container
	Drip tray and drip tray cover
Once a week (more often if heavily soiled)	Central spout with integrated Cappuccinatore
	Brew unit
	Area underneath the brew unit and the drip tray
	Casing (especially important immediately after descaling)
Once a month	Milk pipework
	Bean container and ground coffee chute
When prompted	Water container filter
	Degrease the brew unit (with 1 cleaning tablet)
	Descal the appliance (with 1 descaling tablet)

Cleaning and care

Cleaning by hand or in the dishwasher

The brew unit is **not** dishwasher safe.

Clean the brew unit by hand only under warm running water. **Do not use washing-up liquid or any other cleaning agent.**

The following components must be cleaned **by hand only**:

- Central spout stainless steel cover
- Brew unit
- Bean container lid
- Lower panel

 Risk of damage as a result of excessively high dishwasher temperatures.

Components may be ruined (e.g. may become warped) if washed in a dishwasher at temperatures higher than 55 °C.

For dishwasher-safe components, always select dishwasher programmes with a maximum temperature of 55 °C.

Contact with natural dyes such as those found in carrots, tomatoes and ketchup may discolour the plastic parts in the dishwasher. This discolouration does not affect the stability of the parts.

The following components are **dishwasher safe**:

- Drip tray and lid
- Drip tray cover
- Waste container
- Water container
- Central spout (without stainless steel cover)
- Ground coffee chute cover

 Danger of burning and scalding on hot components or by hot liquids. Components can become very hot during operation. Touching hot components can cause burning. The liquids and steam dispensed are very hot and can cause scalding. Keep well away from the area underneath the spouts when hot liquids and steam are being dispensed. Always allow the coffee machine to cool down before cleaning it. Please be aware that water in the drip tray can also be very hot.

 Risk of damage due to moisture ingress. The steam from a steam cleaning appliance could reach live electrical components and cause a short circuit. Do not use a steam cleaner to clean the coffee machine.

It is important to clean the machine regularly, as the used coffee grounds will soon go mouldy. Milk residues can go off and can block the milk pipework.

Unsuitable cleaning agents

Contact with unsuitable cleaning agents can alter or discolour the external surfaces. All surfaces are susceptible to scratching. Scratches on glass can in some circumstances lead to breakage.

Remove all cleaning agent residues immediately. To protect the machine and surrounding surfaces from damage, make sure you remove any spillages or splashes of descaling agent immediately.

To avoid damaging the surfaces, do not use:

- cleaning agents containing soda, ammonia, acids or chlorides
- solvent-based cleaning agents
- cleaning agents containing descaling agents (unsuitable for cleaning the housing)
- stainless steel cleaning agents
- dishwasher cleaners (unsuitable for cleaning the housing)
- glass cleaning agents
- cleaning agents for ceramic hobs
- oven cleaner
- abrasive cleaning agents, e.g. powder cleaners and cream cleaners
- hard, abrasive brushes or sponges, e.g. pot scourers, brushes or sponges which have been previously used with abrasive cleaning agents

Cleaning and care

- melamine eraser blocks
- sharp metal scrapers
- steel wool or stainless steel wire scourers

Waste container, drip tray and drip tray cover

Clean the drip tray and waste container **every day** to avoid unpleasant smells and mildew.

The waste container is located in the drip tray. Water from rinsing also collects in the waste container.

A prompt will appear in the display when the drip tray and/or the waste container is full and needs to be emptied. Empty the drip tray **and** the waste container.

 **Danger of burning.**
If the rinsing process has just finished, wait a while before removing the drip tray from the machine. The water used for rinsing will continue to run out of the coffee spouts for a while.

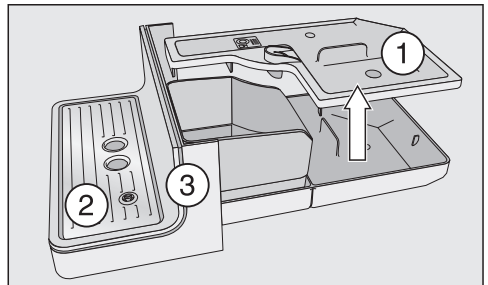

- Pull the drip tray carefully out of the machine. Take the lid ① off.
- Empty the drip tray **and** the waste container.
- Remove drip tray cover ② and lower panel ③.
- Clean all parts thoroughly.

Clean the lower panel by hand only using hot water, a little washing up liquid and a soft cloth. All other parts are dishwasher-safe.

- Clean the inside of the machine underneath the drip tray.
- Reassemble all parts and place the drip tray back in the coffee machine.

Make sure the drip tray has been pushed right into the machine as far as it will go.

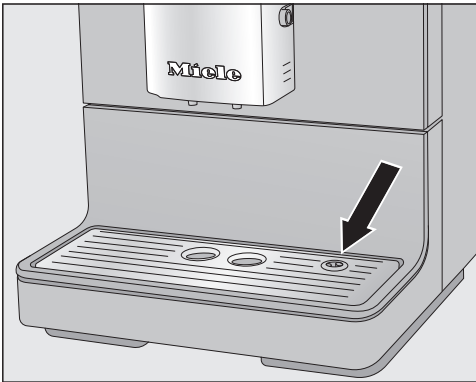

- Make sure that the drip tray cover is correctly fitted (see picture).
- Clean the area under the coffee machine. Water can get under the machine when the drip tray is removed.

Cleaning the water container

Clean the water container every day. You can clean the water container in the dishwasher once a week.

Make sure that the valve, the underside of the water container and the surface the water container sits on are clean. Otherwise, the water container will not sit correctly.

- Remove the water container.
- The water container can be cleaned in the dishwasher, or by hand using hot water and a little washing-up liquid. After cleaning, dry the water container.
- Carefully clean and dry the surface the water container sits on, taking special care to clean the recesses properly.
- Push the water container back into the appliance.

Removing and cleaning the water container filter

Clean the water container filter once a month.

The water container filter is located under the water container.

- Remove the water container.

Cleaning and care

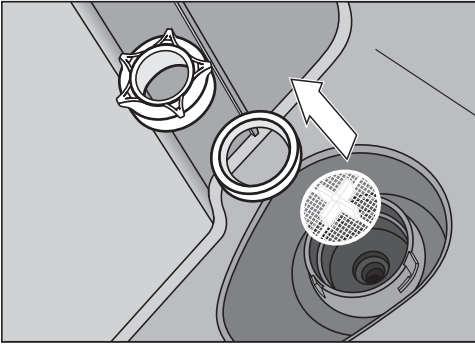

- Unscrew the cap. Remove the sealing ring and the filter.
- Rinse all parts carefully under running water.
- Then replace the water container filter (with the cross facing upwards) and then the sealing ring. Finally screw the cap back on tightly.
- Replace the water container.

Central spout

Clean the central spout's stainless steel cover **by hand only**, using warm water and a little washing-up liquid.

All other parts are dishwasher-safe.



- Carefully pull the stainless steel cover off.

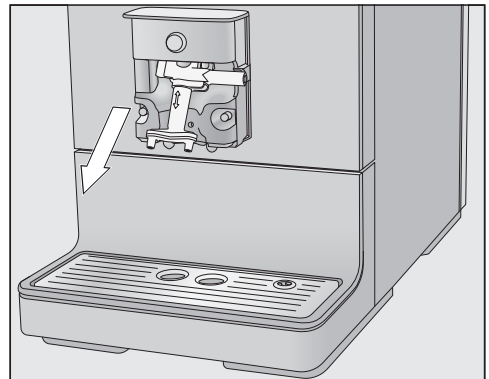

- Pull the dispensing unit down to remove it.

Cleaning and care

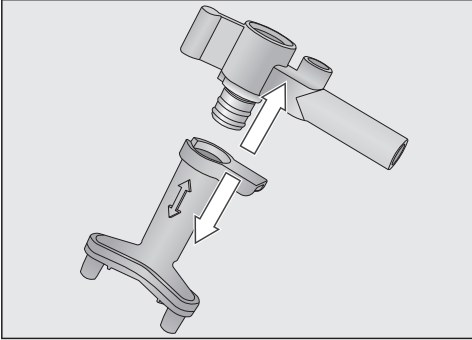

- Release the upper section with the holder for the milk pipework from the dispensing spouts.
- Clean all parts thoroughly.

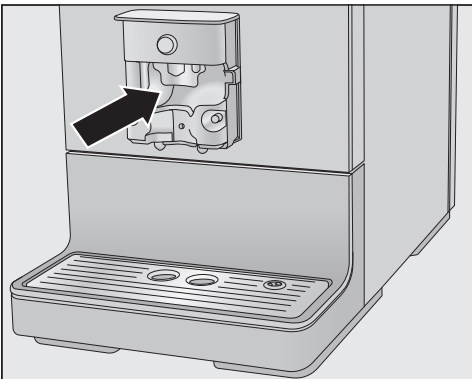

- Clean the surfaces of the central spout and the dispensing spouts with a damp cloth.

Clean any blockages in the milk pipework under running water with the special brush supplied:

- Insert the brush in the pipework. Move it back and forth until all milk residue has been removed.

Reassembling the central spout

The dispensing unit is easier to reassemble if the individual parts are dampened with water beforehand.

- Fit the dispensing unit back together.
- Refit the dispensing unit onto the central spout. Press firmly to ensure the dispensing unit is securely fitted without any gaps.
- Replace the stainless steel cover and connect the milk pipework if required.

Cleaning and care

Milk pipework

 Risk to health due to inadequate cleaning.

Milk naturally contains bacteria. Heat and moisture inside the coffee machine can cause these bacteria to multiply, e.g. milk residues can go off and pose a risk to health.

Clean all components in which milk is transported on a regular basis.

The coffee machine's milk pipework must be cleaned at least every 5 days.

There are two options for cleaning the milk pipework:

- You can remove and dismantle the central spout with its integrated cappuccinatore and either wash it in the dishwasher or by hand with hot water and a little washing-up liquid (see "Central spout with integrated cappuccinatore").
- Or you can clean the milk pipework using the [Clean milk pipework maintenance programme](#) together with cleaning agent for milk pipework (see "Maintenance programmes - Cleaning the milk pipework").

Tip: In addition to your weekly cleaning routine we recommend carrying out the alternative cleaning procedure once a month. For example if you manually clean the machine once a week, then you should run the [Clean milk pipework maintenance programme](#) once a month. This combination will ensure that the milk pipework is cleaned optimally.

Bean container and ground coffee chute

 Danger of injury from the grinder!

Switch off the coffee machine and disconnect it from the power supply before cleaning the bean container.

Coffee beans contain oils which can deposit on the walls of the bean container and hinder the flow of the beans. Therefore, clean the bean container regularly with a soft, dry cloth.

- Open the bean container.
- Remove any coffee beans.
- Clean the bean container with a soft, dry cloth.

The bean container can now be refilled.

If necessary, clean the ground coffee chute:

- Open the coffee chute and remove any ground coffee residue.

Tip: Use a vacuum cleaner to remove any coffee residues from the bean container and the ground coffee chute.

Cleaning the casing

If soiling is allowed to stay on for a long time or there is contact with unsuitable cleaning agents, surfaces can alter or discolour.

Remove any soiling immediately.

Ensure that any splashes of descaler are wiped up immediately.

- Switch the coffee machine off.
- Clean the appliance front with a clean soft sponge and a solution of warm water and washing-up liquid. Then wipe it all dry using a soft cloth.

Tip: You can also clean the appliance casing with the Miele all purpose microfibre cloth.

Opening the Maintenance menu

You can find the maintenance programmes in the Maintenance menu. Run the relevant maintenance programme when the prompt to do so appears in the display.

- Touch the '≡ sensor control.
- Select Maintenance and confirm with *OK*.

You can now select a maintenance programme.

Rinsing the appliance

If you have made a coffee drink, the coffee machine will rinse the coffee pipework automatically before switching off. You can also start the Rinse appliance function manually.

Rinsing the milk pipework

The milk pipework can become blocked by milk residues. The milk pipework should therefore be rinsed regularly. If a drink has been made using milk, the prompt to place the milk pipework into the drip tray will appear at the latest when you switch the machine off.

You can also rinse the milk pipework manually.

- Touch the '≡ sensor control.
- Select Maintenance | Rinse milk pipework and confirm with *OK*.

Cleaning and care

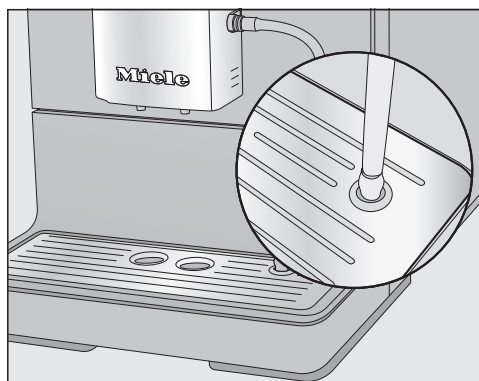

- When prompted, place the milk pipework into the right-hand opening in the drip tray.
- Confirm with *OK*.

The milk pipework will now be rinsed.

Cleaning the milk pipework using the maintenance programme

For optimal cleaning results, we recommend using the Miele cleaning agent for milk pipework. The cleaning agent for milk pipework has been specially developed for use with Miele coffee machines and prevents subsequent damage.

It is available to order via the Miele webshop, the Miele Customer Service Department (see the end of this booklet for contact details) or from your Miele dealer.

To clean the milk pipework you need 1 sachet of cleaning agent for milk pipework.

The Clean milk pipework maintenance programme lasts for approx. 10 minutes.

- Touch the \equiv sensor control.
- Select Maintenance | Clean milk pipework.

The cleaning process cannot be cancelled. It must be completed through to the end.

- Confirm with *OK*.
- The process will start.
- Follow the instructions in the display.

Place milk pipe in cleaning agent will appear in the display.

Preparing the cleaning solution:

- Dissolve the cleaning agent in a container with 200 ml of lukewarm water. Stir the solution with a spoon until the powder has fully dissolved.

Carrying out the cleaning process:

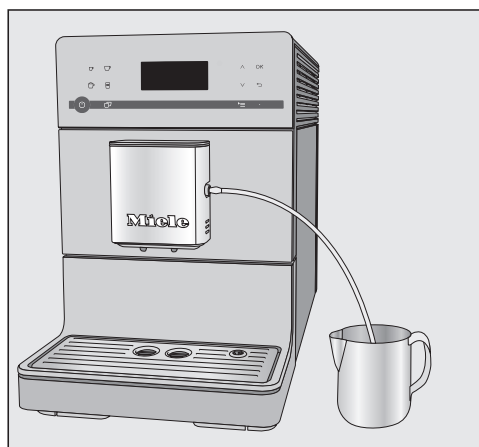

- Place the container next to the coffee machine and hang the milk pipework tube in the solution. Make sure the milk pipework is placed sufficiently far into the cleaning solution.

- Confirm with *OK*.
- Follow the further instructions given in the display.

The cleaning process is finished at the end of the rinsing cycle.

Tip: Flush any residual cleaning agent out of the milk pipework with running water.

Degreasing the brew unit and cleaning the interior

Depending on the natural oil content of the coffee used, the brew unit can become blocked quite quickly. It must be degreased regularly in order to ensure aromatic coffee and trouble-free operation of the coffee machine.

We recommend using Miele cleaning tablets to clean the brew unit. These have been specially developed for degreasing the brew unit in Miele coffee machines and prevent subsequent damage.

The cleaning tablets are available to order via the Miele webshop, the Miele Customer Service Department (see the end of this booklet for contact details) or from your Miele dealer.

The maintenance programme for degreasing the brew unit lasts for approx. 15 minutes.

You need 1 cleaning tablet for the maintenance programme.

After 200 portions have been dispensed, a message prompting you to degrease the brew unit will appear in the display.

- Confirm the message with *OK*.

The message will appear at regular intervals. Once the maximum possible number of portions has been reached, the coffee machine will lock out.

Degrease the brew unit

No drinks can be made and Degrease the brew unit and clean inside the machine appears in the display.

Cleaning and care

The cleaning process cannot be cancelled. It must be completed through to the end.

- Confirm with **OK**.

The maintenance programme will then start.

- Follow the instructions in the display.

Cleaning the brew unit and interior

Clean the brew unit **by hand only** with warm water. **Do not use any cleaning agents.** The moving parts of the brew unit are lubricated. Cleaning agents will damage the brew unit.

To ensure good tasting coffee and to prevent the formation of microbes in the machine, remove and clean the brew unit under running water once a week.

Rinse the brew unit by hand and clean inside the machine will appear in the display.

- Open the appliance door.

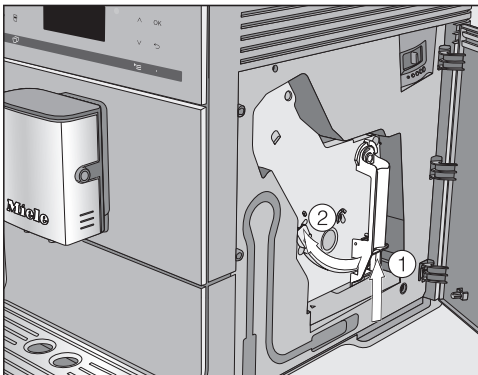

- Press and hold the button under the brew unit handle ① and, whilst doing so, turn the handle to the left ②.

- Carefully pull the brew unit out of the coffee machine.

When you have removed the brew unit, do **not** change the position of the handle on the brew unit.

- Clean the brew unit **by hand under warm running water** without using cleaning agent.

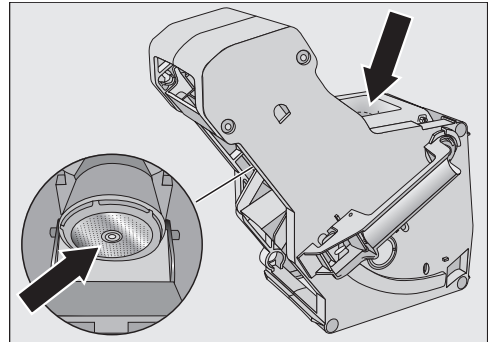

- Wipe any remaining coffee off the filters (see arrows).
- Dry the funnel to prevent ground coffee sticking to it the next time a coffee is made.

⚠ Risk to health due to inadequate cleaning.

Damp coffee residues in the interior of the machine can go mouldy and pose a risk to health.

Remove coffee residues regularly and clean the interior of the machine.

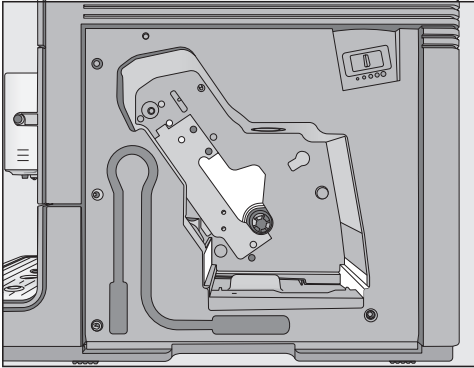

- Clean the inside of the coffee machine. Make sure that the areas highlighted in the illustration are cleaned especially well.

Tip: Use your vacuum cleaner to remove dry ground coffee residues.

Dropping a cleaning tablet into the brew unit

Insert the brew unit with a cleaning tab in it and close the machine will appear in the display.

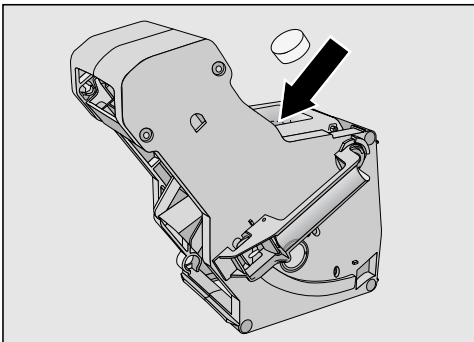

- Drop a cleaning tablet into the top of the brew unit (arrow).
- Push the brew unit containing the cleaning tablet back into the coffee machine.

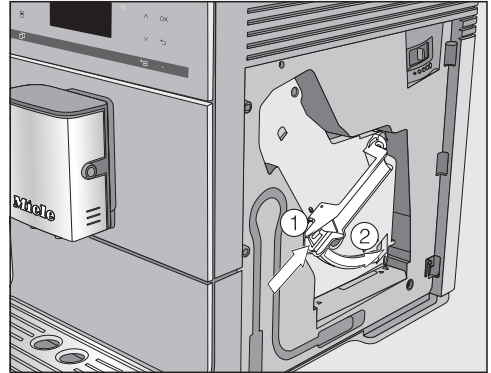

- Press the button under the handle of the brew unit ① and, whilst doing so, turn the handle to the right ②.
- Close the appliance door.
- Follow the further instructions given in the display.

The cleaning process is complete when the drinks menu appears.

Cleaning and care

Descaling the machine

Risk of damage from spilt descaling solution.

Sensitive surfaces and/or natural floors can suffer damage.

Wipe up any spillages of descaling agent immediately.

Limescale builds up in the coffee machine through use. How often the appliance needs to be descaled will depend on the water hardness level in your area. Limescale must be removed regularly.

The appliance will guide you through the descaling process. Various messages will appear in the display, e.g. you will be prompted to empty the drip tray or fill the water container.

Descaling **must be carried out**. The process takes approx. 15 minutes.

The coffee machine prompts you when it needs to be descaled. No. of uses until appliance needs descaling: 50 will appear in the display. The remaining number of drinks that can be made before descaling will now show in the display after each drink is made.

■ Confirm the message with *OK*.

When the number of remaining portions reaches 0, the coffee machine will lock out.

You can switch the coffee machine off if you do not want to carry out the descaling programme at this point in time. You can not make any drinks until the machine has been descaled.

Descaling after prompt appears in the display

Descaling the appliance will appear on the display.

Descaling cannot be cancelled once it has started. It must be completed through to the end.

■ Confirm with *OK*.

The process will start.

■ Follow the instructions in the display.

When Fill water container with descaling agent and lukewarm water up to the  symbol and place in the appliance **appears** in the display, proceed as follows.

Preparing the descaling solution

For optimum descaling results, we recommend using the Miele descaling tablets provided.

The descaling tablets have been specially developed for Miele coffee machines.

Other descalers, which contain other acids besides citric acid and/or other undesirable substances, such as chlorides for example, can cause damage to the product. Moreover, the descaling result required cannot be guaranteed if the descaling solution was not of the appropriate concentration.

Miele descaling tablets are available to order via the Miele webshop, from the Miele Customer Service Department (see the end of this booklet for contact details) or from your Miele dealer.

You will need **1** descaling tablet to descale the machine.

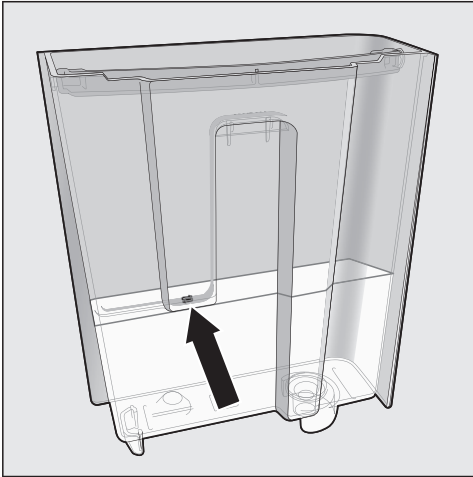

residue remains in the water container. Fill the water container to the  mark with fresh tap water.

The descaling process is complete when the drinks menu appears.

- Place 1 descaling tablet in the water container.
- Fill the water container to the  mark with lukewarm water.

Follow the instructions for the descaler mixing ratio carefully. Fill the water container with the specified amount of water. Otherwise, descaling will be incomplete.

Carrying out descaling

- Push the water container back into the machine.
- Follow the further instructions given in the display.

When Rinse the water container and fill with fresh tap water up to the  symbol appears in the display:

- Remove the water container and rinse it thoroughly with clean water. Ensure that **no** descaling solution

Transporting the machine



If you are not going to use the coffee machine for an extended period of time, e.g. whilst on holiday, or if it needs to be moved, a number of procedures will need be carried out to ensure its safety.

- Empty and clean the coffee bean container
- Empty and clean the water container
- Evaporate the coffee machine
- Clean the inside of the machine
- Pack the machine securely

Evaporating the coffee machine

The coffee machine should be evaporated before it is stored for a long period of time or transported any distance – particularly at temperatures below freezing.

Evaporating the appliance involves removing all traces of water from the system to prevent the risk of water and frost damage.

- Switch the coffee machine on with the On/Off button .
- Touch the  sensor control.
- Touch the  sensor control twice.

Empty the system? will appear in the display.

- Select Yes and confirm with OK.
- Follow the instructions in the display.

 Danger of burning and scalding on the dispensing spouts.

Hot steam can cause scalding.

Keep well away from the area underneath the spouts when hot liquids or steam are being dispensed.

Do not touch hot components.

The evaporation process is finished when Prog. finished appears in the display and the display then goes out.

- Switch off the coffee machine and unplug it to disconnect it from the power supply.
- Clean the drip tray and waste container.

Packing the machine

The coffee machine should only be packed when it is clean and dry. Residues of coffee grounds can cause scratches on surfaces. Coffee and milk residues or water can cause a build-up of bacteria.

Use the original packaging including polystyrene blocks to pack the coffee machine.

Also pack the operating instructions so that they are available when the coffee machine is next used.

Many malfunctions and faults that can occur in daily operation can be easily remedied. Time and money will be saved because a service call will not be needed.



The following guide may help you to find the reason for a malfunction or a fault, and to correct it.

Messages in the display



Error messages must be confirmed with *OK*, otherwise the message can reappear in the display even though the problem has been remedied.

Follow the instructions which appear in the display to remedy the problem.

If after this, the fault message appears in the display again, contact Miele Service.

Problem	Cause and remedy
F1, F2, F80, F82	There is an internal fault. <ul style="list-style-type: none">■ Switch the coffee machine off with the On/Off button . Wait for approximately 1 hour before switching the appliance back on again.
F41, F42, F74, F77, F235, F236	There is an internal fault. <ul style="list-style-type: none">■ Switch the coffee machine off with the On/Off button . Wait for approximately 2 minutes before switching the appliance back on again.
F10, F17	No water or very little water is being drawn in. <ul style="list-style-type: none">■ Remove the water container. Fill the water container with fresh tap water and reinsert the water container.■ Remove and clean the water container filter (see “Cleaning and care – Removing and cleaning the water container filter”).

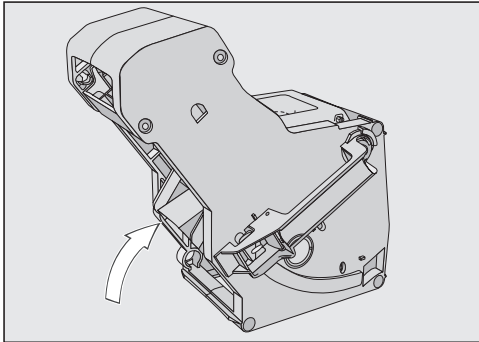
Problem solving guide



Problem	Cause and remedy
<p>F73 or Check the brew unit</p>	<p>The brew unit cannot be positioned correctly.</p> <ul style="list-style-type: none">■ Switch the coffee machine off with the On/Off button .■ Switch off at the wall socket and unplug the coffee machine. Wait for two minutes before inserting the plug back in the socket and switching on.■ Remove the brew unit and rinse under warm running water.  <ul style="list-style-type: none">■ Push the coffee ejector of the brew unit into the correct position.■ Do not fit the brew unit. Close the appliance door and switch the coffee machine on with the On/Off button . <p>This will initialise the brew unit drive and put it back into the start position.</p> <ul style="list-style-type: none">■ When Insert the brew unit appears in the display, put the brew unit back in the appliance. Close the appliance door.

Problem solving guide

Problem	Cause and remedy
Too much ground coffee	<p>There is too much ground coffee in the coffee chute. The brew unit cannot compact ground coffee if more than two level spoonfuls of ground coffee are added to the coffee chute. The ground coffee will be emptied into the waste container and the fault message will appear in the display.</p> <ul style="list-style-type: none">■ Switch the coffee machine off with the On/Off button .■ Remove and clean the brew unit by hand (see “Degreasing the brew unit and cleaning the interior”).■ Remove the ground coffee inside the coffee machine, e.g. with a vacuum cleaner.■ Place a maximum of 12 g of coffee in the ground coffee chute.

Problem solving guide

Unusual performance of the coffee machine

Problem	Cause and remedy
The display remains dark when the coffee machine is turned on using the On/Off button .	The On/Off button  was not held for long enough. ■ Touch and hold the On/Off button  for at least 3 seconds.
	The plug is not inserted in the socket correctly. ■ Insert the plug into the socket.
	The fuse has tripped because the coffee machine, voltage or another appliance is defective. ■ Switch off at the wall socket and unplug the coffee machine. ■ Contact a qualified electrician or the Miele Customer Service Department.
The coffee machine turns off suddenly.	The factory set switch-off time (20 minutes) or the switch-off time you have programmed has been reached. ■ If required, you can select a new switch-off time (see “Settings – Timer”).
	The plug is not inserted in the socket correctly. ■ Insert the plug into the socket.
The sensors do not react to touch. The coffee machine cannot be operated.	There is an internal fault. ■ Disconnect the machine from the power supply by removing the plug from the socket.
The display is hard to see or not able to be read.	The display brightness has been set too low. ■ Change this setting (see “Settings”).

Problem solving guide

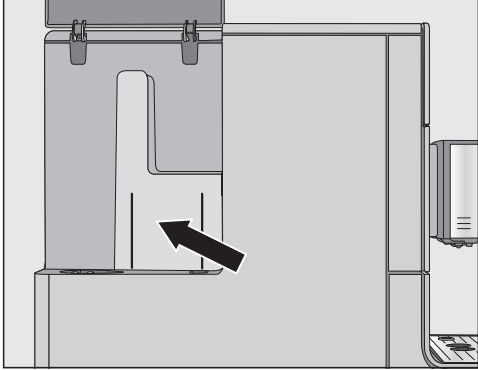
Problem	Cause and remedy
<p>The water container is empty. Fill and replace the water container has not appeared in the display.</p>	<p>Droplets of water have settled between the water container and the side walls of the casing, or this area is damp (see illustration).</p>  <ul style="list-style-type: none"> ■ Dry these surfaces thoroughly. Take the water container out to refill it with water. <p>There is too much residual water on the inside walls of the water container, e.g. a biofilm has developed. Or the water container has a build-up of limescale.</p> <ul style="list-style-type: none"> ■ Clean the water container every day.
<p>Fill and replace the water container appears in the display even though the water container is full and in the machine.</p>	<p>The water container is not in the correct position.</p> <ul style="list-style-type: none"> ■ Remove the water container and push it back in again. <p>The water container was not correctly filled and refitted for descaling.</p> <ul style="list-style-type: none"> ■ Fill the water container to the descaling symbol ☞ and restart the descaling programme.
<p>Fill and replace the water container appears after switching on even though the container is filled and fitted in the machine. The appliance does not rinse.</p>	<p>The coffee machine needs descaling.</p> <ul style="list-style-type: none"> ■ Switch the coffee machine off with the On/Off button ⏻. Wait approx. 1 hour. ■ Switch the appliance back on again. As soon as Heating-up phase appears, touch the ☐ sensor control and then select Descale the appliance. ■ Descal the coffee machine.

Problem solving guide

Problem	Cause and remedy
<p>After switching on the machine the message Empty the drip tray and the waste container appears even though they are both empty.</p>	<p>This is not a fault. When the drip tray and waste container are emptied, the internal counter is not reset after the coffee machine has been switched off. Empty the drip tray and the waste container appears in the display even though the drip tray and the waste container are not filled to the maximum.</p>
<p>Neither milk nor milk froth comes out of the central spout.</p>	<p>The milk pipework is blocked.</p> <ul style="list-style-type: none"> ■ Clean the central spout, taking particular care to clean the cappuccinatore and milk pipework connections carefully with the cleaning brush.
<p>Empty the drip tray and the waste container appears in the display, even though the drip tray has been emptied.</p>	<p>This is not a fault. The drip tray was not properly removed and/or replaced too quickly.</p>
<p>Insert the drip tray and the waste container appears in the display even though both are fitted.</p>	<p>The drip tray is not in the correct position and is therefore not detected.</p> <ul style="list-style-type: none"> ■ Empty the drip tray and the waste container. Reassemble all parts and push the drip tray back as far as it will go in the coffee machine.
<p>The drip tray or waste container is full or overflowing, although they have been emptied following each reminder.</p>	<p>This is not a fault. The drip tray and waste container were probably removed or the machine was opened without the drip tray and waste container being emptied. When the drip tray is removed or the machine opened, the internal counter for emptying the drip tray and waste container is automatically reset.</p> <ul style="list-style-type: none"> ■ Remove the drip tray and waste container from the machine and empty them.

Problem solving guide

Problem	Cause and remedy
<p>Fill the bean container appears in the display even though the bean container has just been filled.</p>	<p>This is not a fault.</p> <ul style="list-style-type: none"> ■ Confirm the message with <i>OK</i>. <p>Insufficient coffee beans are getting into the grinder. Have you used a dark roast? This type of coffee bean is often more oily. These oils can cling to the inside of the coffee bean container and hinder the flow of beans.</p> <ul style="list-style-type: none"> ■ Make a coffee and observe whether the coffee beans drop into the coffee bean container. ■ Clean the coffee bean container more often if you are using a darker, more oily bean. <p>Try other types of coffee bean which are less oily.</p>
<p>The coffee machine does not rinse itself when turned on.</p>	<p>This is not a fault.</p> <p>If the coffee machine is already at operating temperature, rinsing will not take place.</p>
<p>Coffee dispensing is repeatedly interrupted and the message Fill the bean container appears in the display.</p>	<p>This is not a fault.</p> <p>The brew unit has not detected the ground coffee. Certain types of coffee produce a small amount of coffee when they are ground. Usually this is because the grinder is set too fine and the minimum quantity of coffee is set.</p> <ul style="list-style-type: none"> ■ Confirm the message with <i>OK</i>. <p>If the coffee is too strong for you or tastes bitter, try a different type of coffee beans.</p> <p>If the display appears with all types of coffee:</p> <ul style="list-style-type: none"> ■ Set the grinder to a coarser setting (see “Grinder setting”). ■ Select a larger quantity of coffee. <p>Don't forget to check any drinks changed in “Profiles”.</p> <p>If the message only appears when dispensing certain drinks:</p> <ul style="list-style-type: none"> ■ Check the quantity of coffee set for this drink (see “Quantity of coffee”). Select a larger quantity of coffee. ■ You may also need to set a coarser grinder setting.

Problem solving guide

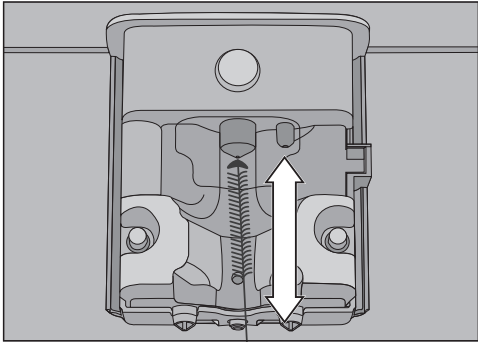
Problem	Cause and remedy
The descaling process was started inadvertently.	<p>The descaling programme cannot be stopped once OK has been touched. It must now be completed through to the end. This is a security setting to fully descale the coffee machine. It ensures a long service life and that your coffee machine is functioning correctly.</p> <ul style="list-style-type: none">■ Descal the coffee machine (see “Descaling the appliance”).
The milk sputters when it is dispensed. Hissing noises can be heard when milk is being heated up or frothed. Although the milk should be frothed, only hot milk comes out of the main dispenser.	<p>The milk temperature is too high. Good milk froth can only be achieved with cold milk (below 10°C).</p> <ul style="list-style-type: none">■ Check the temperature of the milk.
	<p>The central dispenser with integrated cappuccinatore is not correctly fitted and is taking in air. Or the spouts are blocked.</p> <ul style="list-style-type: none">■ Check whether the central spout has been assembled correctly. Make sure that all parts are tightly connected to one another.■ If necessary, clean the central spout.
	<p>The milk pipework, connections or the intake tube on the milk flask are blocked.</p> <ul style="list-style-type: none">■ Clean all parts thoroughly.
	<p>The steam jet on the central spout has a blockage.</p>  <p>Push the cleaning brush a max. of 1 cm into the steam jet.</p> <ul style="list-style-type: none">■ Clean the steam jet with the cleaning brush.

Problem solving guide

Problem	Cause and remedy
<p>Coffee grounds have settled on the lid of the drip tray and in the interior around the brew unit.</p>	<p>This is not a fault. The movement of the brew unit during the brewing process can cause some ground coffee to fall around it. The type of beans used, the fineness of the ground coffee and the quantity of coffee ground also affect the quantity. Important! Clean the inside of the coffee machine regularly to prevent mould etc. Check whether the quantity of coffee is set too high.</p>
<p>The underside of the coffee bean container cover is very damp Drops of water are visible.</p>	<p>Too many drinks have been made one after the other and the ground coffee chute is not closed or not properly closed. Steam has risen up from the brew unit via the ground coffee chute and condensed under the cover.</p> <ul style="list-style-type: none"> ■ Replace the lid on the ground coffee chute making sure it is properly sealed.
<p>Water from making coffee has collected on the worktop underneath the coffee machine.</p>	<p>This is not a fault. Water can get under the machine when the drip tray is removed. Clean the surfaces underneath the coffee machine regularly.</p>
<p>The display lights up but the coffee machine does not heat up and no drinks are made. The coffee machine cannot be turned off.</p>	<p>The Demo mode for demonstrating the coffee machine in the showroom has been activated.</p> <ul style="list-style-type: none"> ■ Deactivate Demo mode.

Problem solving guide

Unsatisfactory results

Problem	Cause and remedy
The coffee is not hot enough.	The cup has not been pre-heated. The smaller the cup and the thicker its sides, the more important it is to pre-heat it. ■ Pre-heat the cup, for example, with hot water.
	The brewing temperature has been set too low. ■ Set a higher brewing temperature.
	The filters in the brew unit are blocked. ■ Remove the brew unit and clean by hand ■ Degrease the brew unit.
The heating-up time is getting longer, the amount of water being dispensed is incorrect and the coffee machine is not performing properly. Coffee flows very slowly out of the central spout.	The coffee machine needs descaling. ■ Descale the coffee machine.
Coffee is not flowing out of the central spout. Or coffee is only being dispensed via one spout.	The central spout has a blockage. ■ Clean the coffee pipework (see "Cleaning and care - Rinsing the machine). ■ If there is still no coffee coming out, or coffee is only coming out of one side, clean the dispensing spouts with the cleaning brush.
The consistency of the milk froth is unsatisfactory.	The milk temperature is too high. Good milk froth can only be achieved with cold milk (below 10 °C). ■ Check the temperature of the milk in the milk flask.
	The milk pipework is blocked. ■ Clean the central spout and milk pipework with the brush.

Problem solving guide

Problem	Cause and remedy
The coffee grinder makes a louder noise than usual.	<p>The coffee bean container has become empty during the grinding process.</p> <ul style="list-style-type: none">■ Fill the coffee bean container with fresh beans. <p>There may be foreign objects such as plastic or stones in amongst the coffee beans.</p> <ul style="list-style-type: none">■ Switch the coffee machine off immediately. Call Service.
The coffee flows too quickly into the cup.	<p>The coffee is too coarsely ground.</p> <ul style="list-style-type: none">■ Set the grinder to a finer setting (see “Grinder setting”).
The coffee is dispensed too slowly into the cup.	<p>The brew unit is blocked.</p> <ul style="list-style-type: none">■ Degrease the brew unit (see “Cleaning and care – Degreasing the brew unit and cleaning the interior”).
There is no crema on the coffee or espresso.	<p>The coffee beans are no longer fresh. If roasted coffee beans are stored open for too long, the carbon dioxide gradually escapes from the coffee beans. The crema is no longer formed during dispensing.</p> <p>Of course, you can still use the coffee beans.</p>

After sales service and warranty

Contact in the event of a fault

In the event of any faults which you cannot remedy yourself, please contact your Miele dealer or the Miele Customer Service Department.

You can book a Miele Customer Service Department call-out online at www.miele.com/service.

Contact information for the Miele Customer Service Department can be found at the end of this document.

Please quote the model identifier and serial number of your appliance (Fabr./SN/Nr.) when contacting the Miele Customer Service Department. This information can be found on the data plate.

Please note that telephone calls may be monitored and recorded for training purposes and that a call-out charge will be applied to service visits where the problem could have been resolved as described in this booklet.

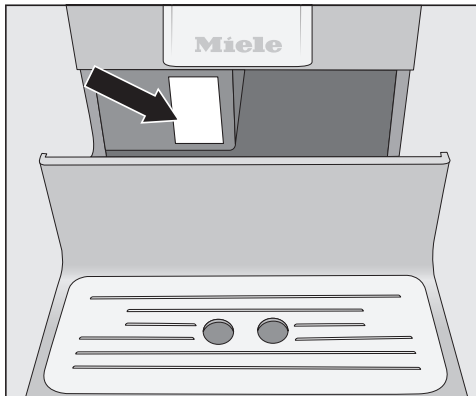

Warranty

For information on the appliance warranty specific to your country please contact Miele. See back cover for address.

In the UK, your appliance warranty is valid for 2 years from the date of purchase. However, you must activate your cover by calling 0330 160 6640 or registering online at www.miele.co.uk.

The following tips can help you save energy and money as well as care for the environment:

- Operate the coffee machine in Eco mode (default setting).
- The coffee machine's energy consumption may increase if you change the settings for the timer.

This setting uses more energy **appears in the display.**

- Switch the coffee machine off with the On/Off button  when it is not in use.
- Change the setting for the "Switch off after" timer to 15 minutes. The coffee machine will then switch itself off 15 minutes after the last drink was made or a sensor control was touched.

Electrical connection

Before connecting the coffee machine, make sure that the connection data on the data plate (voltage and frequency) matches that of the electricity supply. This data must match in order to avoid the risk of damage to the coffee machine. If in any doubt, consult a qualified electrician.

The required connection data is provided on the data plate. The data plate can be seen on the left-hand side of the machine when the drip tray is pulled out.

The appliance is supplied with a mains cable ready for connection to an AC 220–240 V 50 Hz supply.

The coffee machine must be connected to the mains supply via a suitable earthed socket. Connection must comply with national and local safety regulations (BS 7671 in the UK).

The fuse rating must be at least 10 A.

The socket should be next to the appliance and easily accessible where possible.

Do not connect the coffee machine to the mains electricity supply using a multi-socket adapter or an extension lead. These do not guarantee the required safety of the machine (fire risk).

Do not connect the coffee machine to a **stand-alone inverter**. Stand-alone inverters are used for autonomous power supply, e.g. a solar power system. Power surges could trigger the Auto switch off function. This could damage the electronic module.

The coffee machine must not be used with “**energy saving plugs**”. These reduce the amount of energy supplied to the appliance, causing it to overheat.

If the mains connection cable is faulty, it must only be replaced by a qualified electrician in order to avoid a hazard.

 Danger of overheating due to insufficient ventilation.

If the coffee machine is not sufficiently ventilated, the appliance can overheat.

Please ensure that there is adequate ventilation around the coffee machine.

Do not cover the coffee machine with tea towels etc. while it is in use.

If the coffee machine is installed behind a closed furniture front, heat and moisture can build up behind the furniture front when closed. This can result in damage to the coffee machine and/or furniture unit.

Do not close the furniture front while the coffee machine is in use.

Please observe the following installation instructions:

- The location of the machine must be dry and well ventilated.
- The ambient temperature of the room in which the machine is used must be between 10 °C and 38 °C.
- The machine must be set up on a level surface. The surface must be water resistant.

If the machine is installed in a niche, the niche must provide the following minimum dimensions:

Height	510 mm
Width	450 mm
Depth	575 mm

When setting up the machine: make sure that the service panel can be fully opened so that the brew unit can be removed with ease when required.

- The machine must be set up in the niche such that it sits flush with the front edge of the niche.

Dimensions

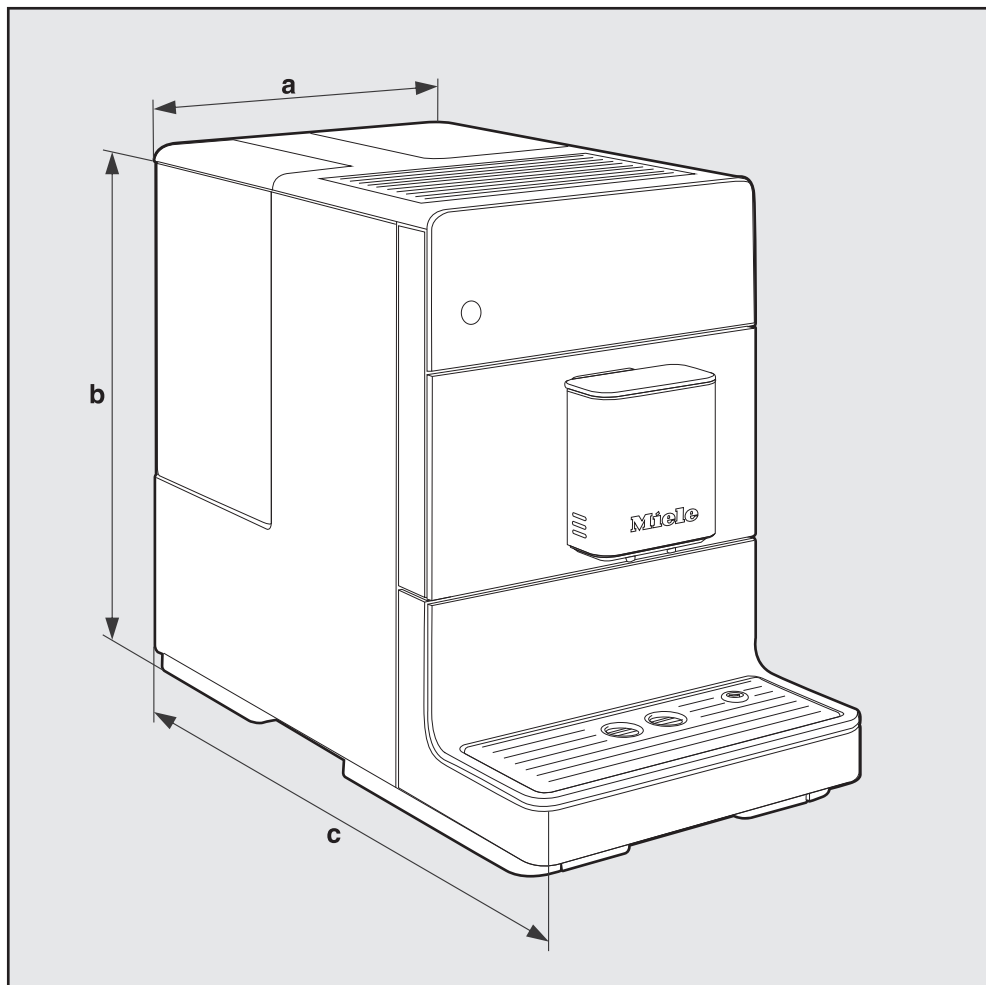

a = 241 mm

b = 360 mm

c = 460 mm

Technical data

Electricity consumption in standby mode (default setting):	< 0.5 Watt
Pump pressure:	max. 15 bar
Through-flow heater:	1 stainless steel thermo block
Dimensions (W x H x D):	241 x 360 x 460 mm
Net weight:	9.48 kg
Connection cable length:	120 cm
Water container capacity:	1.3 l
Bean container capacity:	200 g
Waste container capacity:	max. 6 portions of coffee grounds
Central spout:	Height adjustable from 80–135 mm
Grinder:	Steel conical grinder
Grinder setting:	5 settings
Ground coffee amount:	max. 12 g

United Kingdom

Miele Co. Ltd., Fairacres, Marcham Road, Abingdon, Oxon, OX14 1TW

Tel: 0330 160 6600, Internet: www.miele.co.uk/service, E-mail: info@miele.co.uk

Australia

Miele Australia Pty. Ltd.

ACN 005 635 398

ABN 96 005 635 398

Level 4, 141 Camberwell Road

Hawthorn East, VIC 3123

Tel: 1300 464 353

Internet: www.miele.com.au

China Mainland

Miele Electrical Appliances Co., Ltd.

1-3 Floor, No. 82 Shi Men Yi Road
Jing' an District

200040 Shanghai, PRC

Tel: +86 21 6157 3500

Fax: +86 21 6157 3511

E-mail: info@miele.cn,

Internet: www.miele.cn

Hong Kong, China

Miele (Hong Kong) Ltd.

41/F - 4101, Manhattan Place

23 Wang Tai Road

Kowloon Bay, Hong Kong

Tel: (852) 2610 1025

Fax: (852) 3579 1404

Email:

customerservices@miele.com.hk

Website: www.miele.hk

India

Miele India Pvt. Ltd.

1st Floor, Copia Corporate Suites,
Commercial Plot 9,

Mathura Road, Jasola,

New Delhi - 110025

E-mail: customercare@miele.in

Website: www.miele.in

Manufacturer: Miele & Cie. KG, Carl-Miele-Straße 29, 33332 Gütersloh, Germany

Ireland

Miele Ireland Ltd.

2024 Bianconi Avenue

Citywest Business Campus

Dublin 24

Tel: (01) 461 07 10

Fax: (01) 461 07 97

E-Mail: info@miele.ie

Internet: www.miele.ie

Kuwait

Miele Kuwait

Al Wazzan United Trading Co.

P. O. Box : 3379

Hawally, 32034 Kuwait

Tel.: 00965-22001010

Fax: 00965-24838292

E-mail: mail@alwazzanunited.com

Website: www.alwazzanunited.com

Malaysia

Miele Sdn Bhd

Suite 12-2, Level 12

Menara Sapura Kencana

Petroleum

Solaris Dutamas No. 1

Jalan Dutamas 1

50480 Kuala Lumpur, Malaysia

Phone: +603-6209-0288

Fax: +603-6205-3768

New Zealand

Miele New Zealand Limited

IRD 98 463 631

8 College Hill

Freemans Bay, Auckland 1011

New Zealand

Tel: 0800 464 353

Internet: www.miele.co.nz

Singapore

Miele Pte. Ltd.

29 Media Circle

#11-04 ALICE@Mediapolis

Singapore 138565

Tel: +65 6735 1191

Fax: +65 6735 1161

E-Mail: info@miele.com.sg

Internet: www.miele.sg

South Africa

Miele (Pty) Ltd.

63 Peter Place, Bryanston 2194

P.O. Box 69434, Bryanston 2021

Tel: (011) 875 9000

Fax: (011) 875 9035

E-mail: info@miele.co.za

Internet: www.miele.co.za

Thailand

Miele Appliances Ltd.

BHIRAJ TOWER at EmQuartier

43rd Floor Unit 4301-4303

689 Sukhumvit Road

North Klongton Sub-District

Vadhana District

Bangkok 10110, Thailand

United Arab Emirates

Miele Appliances Ltd.

Showroom 1, Eiffel 1 Building

Sheikh Zayed Road, Umm Al Sheif

P.O. Box 114782 - Dubai

Tel. +971 4 3044 999

Fax. +971 4 3418 852

800-MIELE (64353)

E-Mail: info@miele.ae

Website: www.miele.ae

CM 5310, CM 5315, CM 5410, CM 5510, CM 5710